

## Your Operator's Manuals



### Digital in the vehicle

Discover the Operator's Manual in the multimedia system under "Vehicle".  
Begin with Quick Start, discover highlights and useful tips.



### Vehicle document wallet in the vehicle

Here you can find information on operation, service work and the warranty for your vehicle in printed form.

The new eSprinter



Mercedes-Benz

## The new eSprinter

Operator's Manual

Mercedes-Benz



9075844614

Order no. T907 0567 13 Part no. 907 584 46 14 Edition C-2024

## Front passenger air bag warning

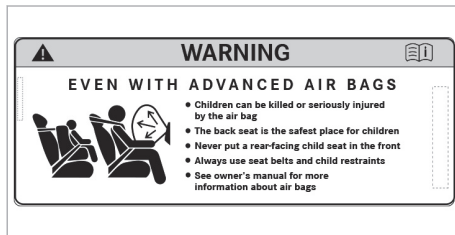

Air bag warning sticker for USA and Canada

### **WARNING** Risk of injury or fatal injuries if the front passenger air bag is enabled

If the front passenger air bag is enabled, a child on the front passenger seat may be struck by the front passenger air bag in the event of an accident.

- ▶ NEVER use a rearward-facing child restraint system on a seat with an ENABLED FRONT AIR BAG. This can result in the DEATH of or SERIOUS INJURY to the CHILD.

Observe the chapter entitled "Children in the vehicle".

## Publication details

### Internet

Further information about Mercedes-Benz vehicles and about Mercedes-Benz AG can be found on the following websites:

<https://www.mercedes-benz.com>

<https://www.mbusa.com> (USA only)

<https://www.mercedes-benz.ca> (Canada only)

### Editorial team

© Mercedes-Benz Vans, LLC

© Mercedes-Benz AG: Not to be reprinted, translated or otherwise reproduced, in whole or in part, without written permission from Mercedes-Benz AG.

### Vehicle manufacturer

Mercedes-Benz AG

Mercedesstraße 120

70372 Stuttgart

Germany

### Vehicle dealer

#### Mercedes-Benz USA, LLC

One Mercedes-Benz Drive

Sandy Springs, GA 30328

<https://www.mbusa.com> (USA only)

<http://www.mbsprinterusa.com>

Customer Assistance Center:

1-877-762-8267

#### Mercedes-Benz Canada, Inc.

2680 Matheson Blvd E, Suite 400

Mississauga, ON L4W 0A5

<https://www.mercedes-benz.ca> (Canada only)

Customer Assistance Center:

1-800-387-0100

Mercedes-Benz USA, LLC and Mercedes-Benz Canada, Inc. are Mercedes-Benz Group AG enterprises.

Canada only: "Authorized Sprinter Dealer" is defined as an authorized Mercedes-Benz Sprinter Dealer.



## Welcome to the world of Mercedes-Benz

Before you first drive off, read this Operator's Manual carefully and familiarize yourself with your vehicle. For your own safety and a longer operating lifespan, follow the instructions and warning notices in this Operator's Manual. Disregarding them may result in damage to the vehicle or environment or in injuries to people.

Vehicle damage caused by failure to observe the instructions is not covered by the New Vehicle Limited Warranty.

The standard equipment and product description of your vehicle may vary, depending on the following factors:

- Model
- Order
- National version
- Availability

Mercedes-Benz reserves the right to introduce changes in:

- Design
- Equipment
- Technical features

Your vehicle may therefore differ, in individual cases, from that shown in the descriptions and illustrations.

The following documents are integral parts of the vehicle:

- Digital Operator's Manual
- Printed Operator's Manual
- Service booklet
- Equipment-dependent supplements

Always keep these documents in the vehicle. If you sell the vehicle, always pass all documents on to the new owner.

Mercedes-Benz Vans, LLC

Mercedes-Benz Canada, Inc.

A Mercedes-Benz Group AG Company

**Symbols** ..... 4**At a glance** ..... 6

Cockpit	6
Instrument cluster	7
Overhead control panel	8
Door operating unit	10
Emergencies and breakdowns	12

**Digital Operator's Manual** ..... 13

Calling up the Digital Operator's Manual	13
--	----

**General notes** ..... 14

Environmental protection	14
Mercedes-Benz Genuine Parts	14
Attachments, add-on equipment, installations and conversions	15
Operator's Manual	16
Service and vehicle operation	16
Operating safety	17
Declarations of conformity and notes on driving in different countries	19
Diagnostics connection	19
Qualified specialist workshop	20
Vehicle registration	20
Correct use of the vehicle	20
Multi-purpose vehicle	20
Notes for persons with electronic medical aids	21
Problems with your vehicle	21
"Reporting safety defects"	22
Limited Warranty	22
QR codes for rescue card	22
Data storage	22
Copyright	25

**Occupant safety** ..... 27

Brief overview of most important points	27
Information on the automatic functions of the restraint system	30
Purpose and function of the restraint system	30
Seat belts	34
Airbags	34

**Children in the vehicle** ..... 35

Brief overview of most important points	35
Important safety notes	35
Securing the child restraint system	37

**Opening and closing** ..... 39

SmartKey	39
Doors	41
Sliding door	45
Electric sliding door	46
Rear-end doors	49
Partition sliding door	51
Side window	52
Anti-theft prevention	53

**Seats and stowage** ..... 56

Notes on the correct driver's seat position	56
Notes on grab handles	56
Seats	56
Steering wheel	64
Stowage areas	65
Information about the bottle holder	66
Cup holders	66
Ashtray and cigarette lighter	66
Sockets	67
Wirelessly charging the mobile phone and coupling with the exterior antenna	68
Installing and removing the floor mats	69

**Light and vision** ..... 71

Lighting	71
Adjusting the interior lighting	75
Changing bulbs	77
Windshield wipers	81
Mirrors	83

**Climate control** ..... 86

Overview of climate control systems	86
Operating climate control systems	88
Operating air vents	91
Operating cargo compartment ventilation	91
Pre-entry climate control	92

**Driving and parking** ..... 94

Driving	94
Drive programs	104
Transmission	104
Charging the high-voltage battery	106
Parking	115
Driving and driving safety systems	118
Trailer operation	131



<b>Instrument cluster and on-board computer</b> .....	<b>137</b>	<b>Wheels and tires</b> .....	<b>190</b>
Overview of the instrument cluster .....	137	Information on noise or unusual driving characteristics .....	190
Function of the power availability display ..	137	Notes on regularly inspecting wheels and tires .....	190
Overview of the buttons on the steering wheel .....	138	Information on driving with summer tires .....	190
Overview and operation of the on-board computer .....	138	Information on M+S tires .....	191
Overview of instrument cluster display .....	139	Notes on snow chains .....	191
Function of the charge level display .....	140	Tire pressure .....	192
Display of the available power .....	140	Loading the vehicle .....	197
Adjusting the instrument lighting .....	141	Tire labeling .....	200
Menus and submenus .....	141	Information on definitions (tires and loading) .....	203
<b>Mercedes me</b> .....	<b>144</b>	Changing a wheel .....	205
Mercedes me calls .....	144	Spare wheel .....	211
Mercedes me connect .....	146	<b>Technical data</b> .....	<b>216</b>
Mercedes me and apps .....	147	Information on the technical data .....	216
<b>MBUX multimedia system</b> .....	<b>149</b>	On-board electronics .....	216
Overview and operation .....	149	Radio regulations .....	217
System settings .....	154	Vehicle identification plate, vehicle identification number (VIN) and engine number .....	218
Navigation .....	157	Operating fluids and capacities .....	219
Overview of Smartphone Integration .....	162	Vehicle data .....	222
Web browser overview .....	163	Trailer hitch .....	223
Sound settings .....	163	Cargo tie-down points and carrier systems .....	225
<b>Transporting</b> .....	<b>164</b>	<b>Display messages and warning and indicator lamps</b> .....	<b>227</b>
Notes on loading guidelines .....	164	Display messages .....	227
Notes on distributing the load within the vehicle .....	164	Indicator and warning lamps .....	245
Securing loads .....	165	<b>Index</b> .....	<b>254</b>
Carrier systems .....	166		
Placing a load on the wheel arch .....	167		
<b>Maintenance and care</b> .....	<b>168</b>		
ASSYST PLUS service interval display .....	168		
Calibrating the high-voltage battery .....	168		
Engine compartment .....	171		
Cleaning and care .....	174		
<b>Breakdown assistance</b> .....	<b>179</b>		
Emergency .....	179		
Emergency Call System .....	179		
Flat tire .....	181		
Battery .....	181		
Towing or tow-starting .....	183		
Electrical fuses .....	186		
Vehicle tool kit .....	187		
Hydraulic jack .....	188		

## 4 Symbols

---

In these Operating Instructions, you will find the following symbols:

 **WARNING** Danger due to failure to observe the warning notices

Warning notices draw your attention to hazards that may endanger your health or life, or the health or life of others.

► Observe the warning notices.

 **ENVIRONMENTAL NOTE** Environmental damage due to failure to observe environmental notes

Environmental notes include information on environmentally responsible behavior or environmentally responsible disposal.

► Observe environmental notes.

 **NOTE** Damage to property due to failure to observe notes on material damage

Notes on material damage inform you of risks which may lead to your vehicle being damaged.

► Observe notes on material damage.

 These symbols indicate useful instructions or further information that could be helpful to you.

► Instructions

(→ Further information on a topic page)

Display Messages on the display

 Highest menu level to be selected in the multimedia/audio system

►► Corresponding submenus to be selected in the multimedia/audio system

\* Indicates a cause



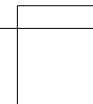
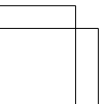
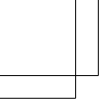

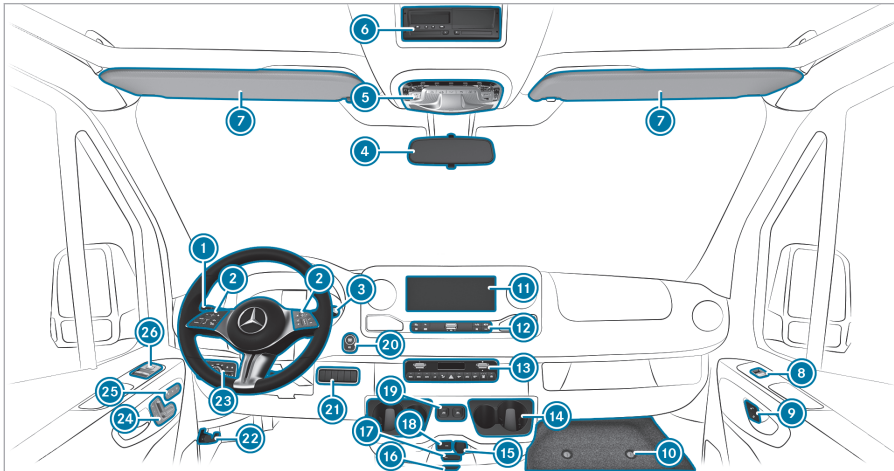

① Combination switch		⑬ Climate control system	→	86	
Turn signal indicators	→	72	⑭ Cup holder	→	65
High beam	→	72	⑮ 230 V socket		
Windshield wipers	→	81	⑯ Key slot for KEYLESS-START	→	97
Rear window wiper	→	81	⑰ 12 V socket	→	67
② Steering-wheel buttons	→	138	⑱ USB port	→	65
③ DIRECT SELECT lever	→	104	⑲ Opens and closes the electric sliding door	→	46
④ Inside rear-view mirror	→	85	⑳ Start/stop button	→	97
Digital inside rear-view mirror	→	84	㉑ Right-hand switch panel		
⑤ Overhead control panel	→	75	Activates/deactivates cargo compartment ventilation	→	91
⑥ Tachograph			㉒ Opens the hood	→	171
⑦ Sun visor			㉓ Light switch	→	71
⑧ Front passenger window lifter	→	52	Headlamp range adjuster	→	72
⑨ Central locking system	→	42	㉔ Adjusts the driver's seat	→	59
⑩ Stowage compartment cover	→	187	㉕ Seat heating	→	64
⑪ MBUX multimedia system display			Central locking system	→	42
⑫ MBUX multimedia system control elements			㉖ Driver's window lifter	→	53



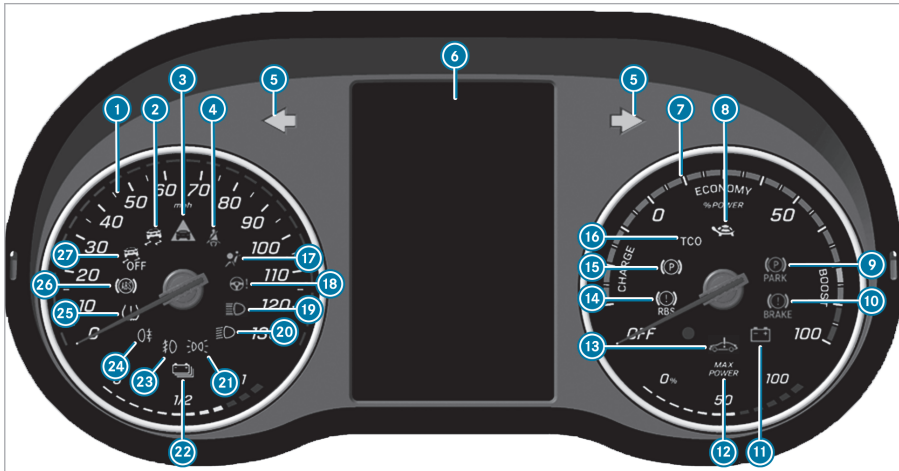

Instrument cluster (example)

**i** The functions of the existing indicator and warning lamps depend on the equipment.

<b>1</b> Speedometer	→	137	<b>14</b> <b>RBS</b> Regenerative brake system	→	95
<b>2</b> ESP®	→	246	<b>15</b> Electric parking brake (yellow)	→	246
<b>3</b> Distance warning	→	252	<b>16</b> <b>TCO</b> Tachograph		
<b>4</b> Seat belt not fastened	→	251	<b>17</b> Restraint system	→	246
<b>5</b> Turn signal light	→	72	<b>18</b> Power steering malfunction	→	252
<b>6</b> Display of indicator and warning lamps			<b>19</b> High beam	→	72
Operational readiness of drive system	→	97	<b>20</b> Low beam	→	71
Condition of charge display for high-voltage battery	→	140	<b>21</b> Side lights	→	71
<b>7</b> Power availability display	→	137	<b>22</b> High-voltage battery reserve	→	252
<b>8</b> Reduced power	→	252	<b>23</b> Fog light	→	71
<b>9</b> Parking brake applied (red)	→	246	<b>24</b> Rear fog light	→	71
<b>10</b> Brake malfunction	→	246	<b>25</b> Tire pressure monitoring system	→	253
<b>11</b> Electrical malfunction	→	235	<b>26</b> ABS malfunction	→	246
<b>12</b> Maximum available output of the drive system	→	140	<b>27</b> ESP® deactivated	→	246
<b>13</b> System error	→	252			

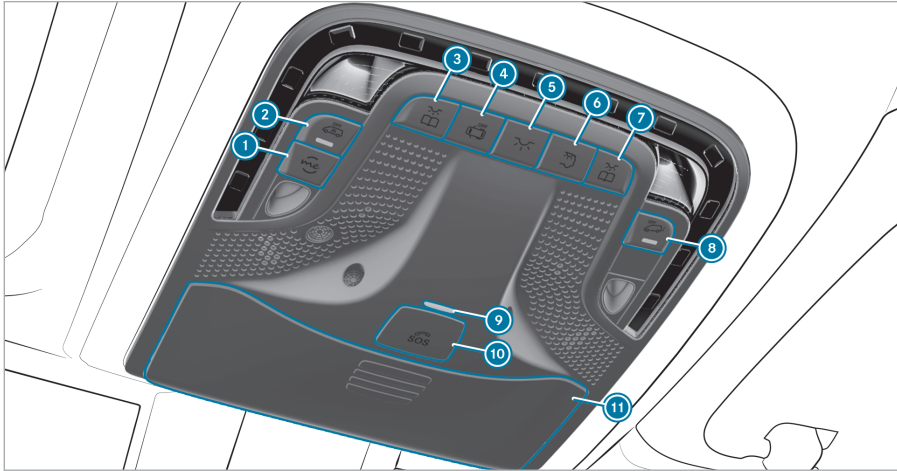

①	me button for service or information calls (breakdown assistance call)	→	144	⑦	Switches the right-hand reading light on/off	
②	Activates/deactivates interior protection	→	55	⑧	Switches the tow-away alarm on/off	→ 54
③	Switches the left-hand reading light on/off			⑨	ATA indicator lamp	→ 53
④	Switches automatic light control on/off			⑩	SOS emergency call button cover	→ 144
⑤	Switches the front interior lighting on/off			⑪	Glasses compartment	
⑥	Switches rear interior lighting on/off (unassigned, depending on equipment)					



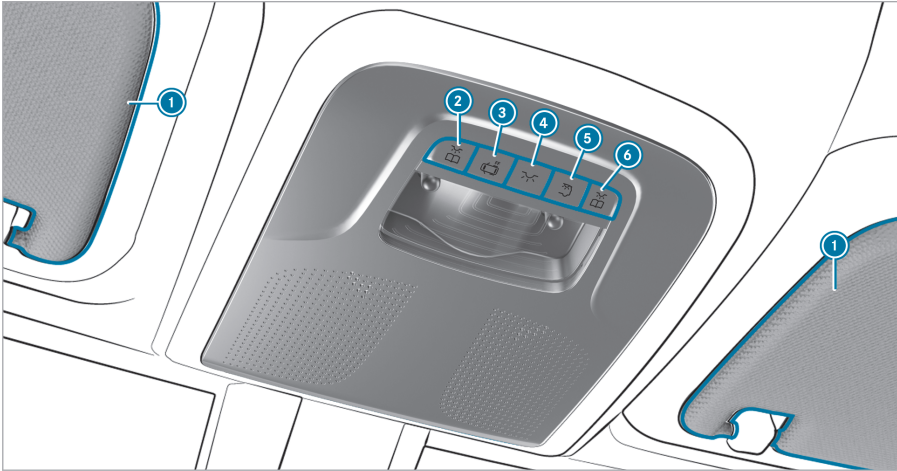



Version 2 of the overhead control panel

- ① Sun visors

---

- ②  Switches the left-hand reading light on/off

---

- ③  Switches automatic light control on/off

---

- ④  Switches the front interior lighting on/off

---

- ⑤  Switches rear interior lighting on/off (unassigned, depending on equipment)

---

- ⑥  Switches the right-hand reading light on/off

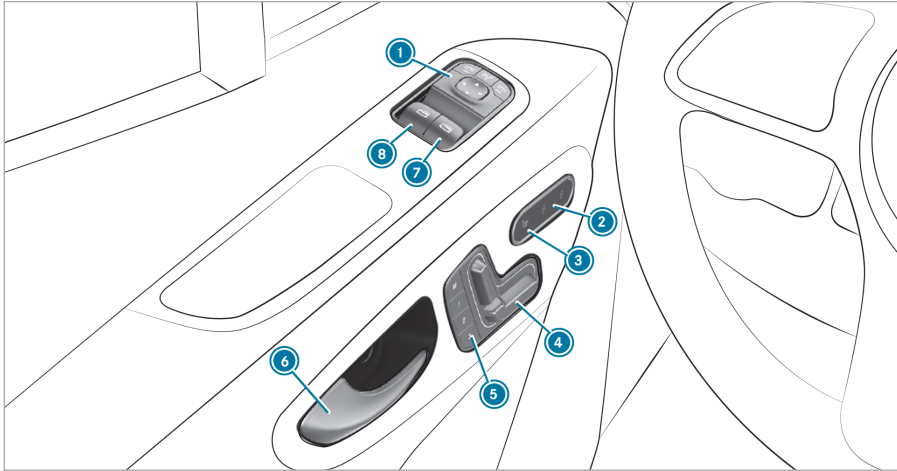



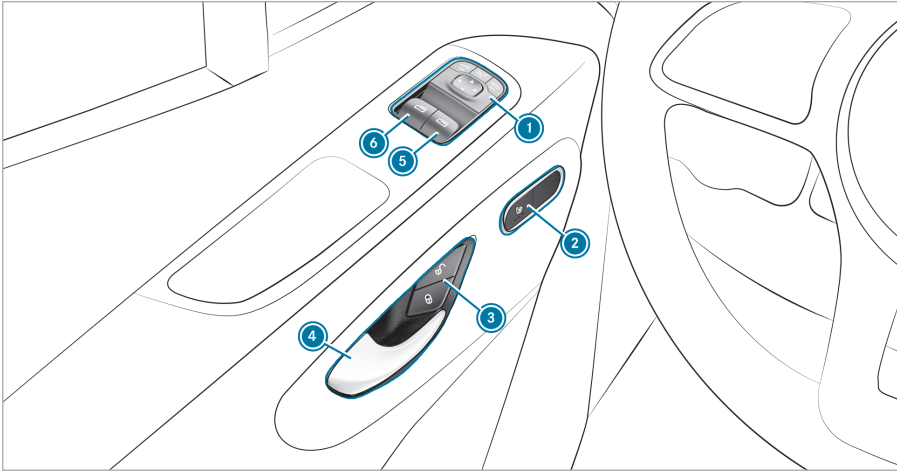

Door operating unit of vehicles with electrically adjustable seat

① Adjusts the outside mirrors →	83	⑤ <b>M 1 2 3</b> Operates the memory function →	61
②   Unlocks/locks the central locking system →	43	⑥ Opens the door →	41
③  Switches seat heating on/off →	64	⑦  Opens/closes the right-hand side window →	52
④ Adjusts the front seats electronically →	59	⑧  Opens/closes the left-hand side window →	52



Door operating unit of vehicles without electrically adjustable seat

① Adjusts the outside mirrors →	83	④ Opens the door →	41
②  Switches seat heating on/off →	64	⑤  Opens/closes the right-hand side window →	52
③   Unlocks/locks the central locking system →	43	⑥  Opens/closes the left-hand side window →	52

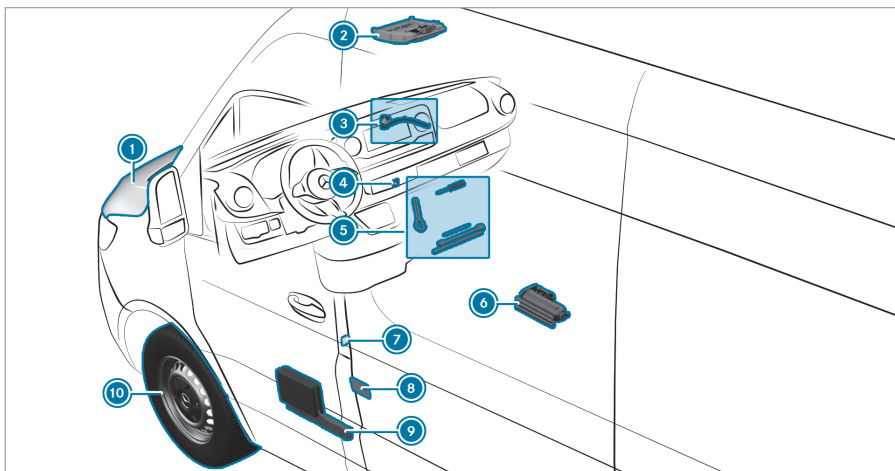

① Checking and topping up operating fluids	→	219	⑧ Information label for tire pressure	→	192
High-voltage disconnect device	→	94	⑨ Warning triangle and emergency medical kit		
② Buttons for the SOS emergency call system and Mercedes me connect	→	180	Safety vest	→	179
③ High-voltage disconnect device at the front in the engine compartment	→	94	First-aid kit (soft-sided)	→	179
④ Hazard warning light system	→	73	⑩ Flat tire	→	181
⑤ Vehicle tool kit	→	207	Further emergency and breakdown devices:		
⑥ Jack	→	188	Spare wheel	→	211
⑦ QR code for accessing the rescue card below the lock strikers of the doors on both driver's and front passenger sides	→	22			

### Calling up the Digital Operator's Manual

Multimedia system:

- ➔ [Home] ➔ Settings ➔ Info
- ➔ Operator's Manual
- ➔ Open Digital Operator's Manual

The Digital Operator's Manual describes the functions and operation of the vehicle and the multimedia system.

- ▶ Select one of the following menu items in the Digital Operator's Manual:
  - **Quick start:** here are the first steps towards adjusting your seat (driver's side).
  - **Tips:** information is provided here to prepare you for certain everyday situations with your vehicle.
  - **Messages:** receive additional information about the messages in the driver display.
  - **Language:** select the language for the Digital Operator's Manual.

You can search for keywords using the search field **Search** in order to find quick answers to questions regarding operation of the vehicle.

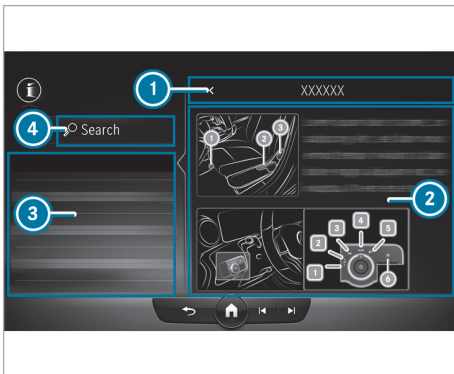

- ① Back
- ② Contents section
- ③ Menu
- ④ Search

Some sections in the Digital Operator's Manual, such as warning notes, can be expanded and collapsed.

#### Additional methods of calling up the Digital Operator's Manual:

**Driver display:** call up brief information as display messages in the driver display. Pressing ① will relay brief information in the central display.

**MBUX Voice Assistant:** call up via the voice control system

**Global search:** call up search results for contents of the Digital Operator's Manual in the Home Screen

- ① The Digital Operator's Manual is deactivated for safety reasons while driving.

## Environmental protection

 **ENVIRONMENTAL NOTE** Environmental damage due to operating conditions and personal driving style

Operate your vehicle in an environmentally responsible manner to help protect the environment. Please observe the following recommendations on operating conditions and personal driving style.

### Operating conditions:

- ▶ Make sure that the tire pressures are correct.
- ▶ Do not carry any unnecessary weight (e.g. roof luggage racks once you no longer need them).
- ▶ Monitor energy consumption.
- ▶ Adhere to the service intervals. A regularly serviced vehicle will contribute to environmental protection.
- ▶ Always have maintenance work carried out at a qualified specialist workshop.

### Personal driving style:

- ▶ Drive carefully and maintain a suitable distance from the vehicle in front.
- ▶ Avoid frequent, sudden acceleration and braking.
- ▶ Drive in a way that conserves energy. Pay attention to the ECO display for an economical driving style.

 **ENVIRONMENTAL NOTE** Environmental pollution caused by irresponsible disposal of the high-voltage battery

A high-voltage battery contains materials which are harmful to the environment.

- ▶ Dispose of defective high-voltage batteries at a qualified specialist workshop.

### Environmental issues and recommendations

It is recommended that you re-use or recycle materials instead of simply disposing of them.

The relevant environmental guidelines and regulations serve to protect the environment and should be followed carefully.

## Mercedes-Benz Genuine Parts

 **ENVIRONMENTAL NOTE** Environmental damage due to not using recycled reconditioned components

Mercedes-Benz AG offers recycled reconditioned components and parts with the same quality as new parts. The same entitlement from the Limited Warranty is valid as for new parts.

- ▶ Use recycled reconditioned components and parts from Mercedes-Benz AG.

 **NOTE** Impairment of the operating efficiency of the restraint systems due to the installation of accessory parts or due to repairs or welding

Air bags and seat belt tensioners as well as control units and sensors for the restraint systems may be installed in the following areas of your vehicle:

- Door frame
- Roof frame
- Doors
- Door pillars
- Sill
- Seats
- Cockpit
- Instrument cluster
- Center console

- ▶ Do not install accessory parts such as audio systems in these areas.
- ▶ Do not carry out repairs or welding.
- ▶ Have accessories retrofitted at a qualified specialist workshop.

If you use parts, tires, wheels or safety-relevant accessories that have not been approved by Mercedes-Benz, the operating safety of the vehicle may be jeopardized. Safety-relevant systems such as the brake system may malfunction. Only use Mercedes-Benz Genuine Parts or parts of equal quality. Only use tires, wheels and accessory parts that are approved for your vehicle model.

Mercedes-Benz tests original parts, conversion parts and accessory parts that have been approved for your vehicle model for reliability, safety and suitability. Despite ongoing market research, we are unable to assess other parts. We

therefore accept no responsibility for the use of such parts in Mercedes-Benz vehicles, even if they have been officially approved or independently approved by a testing center.

In some other countries, certain parts are officially approved for installation or modification only if they comply with legal requirements. All Mercedes-Benz Genuine Parts satisfy these requirements. Make sure that all parts are suitable for your vehicle.

Always specify the vehicle identification number (VIN) and the engine number when ordering Mercedes-Benz Genuine Parts (→ page 218).

### Attachments, add-on equipment, installations and conversions

#### Notes on body/equipment mounting directives

For safety reasons, have add-on equipment produced and installed in accordance with the valid Mercedes-Benz body/equipment mounting directives. These body/equipment mounting directives ensure that the chassis and add-on equipment form one unit and that the greatest possible level of operational and driving safety is achieved.

Both vehicle manufacturers and body manufacturers must always ensure that the products they manufacture come into circulation only in a safe state and do not pose any risks to people. Otherwise, there may be consequences under civil, criminal or public law. All manufacturers are responsible for the products that they have manufactured. Manufacturers of attachments, add-on equipment, installations and conversions must guarantee compliance with Directive 2001/95/EC on general product safety.

The body manufacturer must also ensure compliance with standards concerning operational reliability (in accordance with ISO 26262) and cyber security (in accordance with ISO 21434 and UN R155).

Mercedes-Benz recommends the following procedure for safety reasons:

- Do not make any other changes to the vehicle.
- Obtain approval from the dealer named on the inside title page in the event of deviations from the approved body/equipment mounting directives.

Acceptance tests performed by public test bodies or official approvals do not rule out safety risks.

Observe the information about Mercedes-Benz Genuine Parts (→ page 14).

- ❗ You can obtain further information at a qualified specialist workshop.
- ❗ You can find further information on requesting a check for compatibility with the basic vehicle in the body/equipment mounting directives.
- ❗ Structural changes to high-voltage components, high-voltage lines and equipotential bonding lines are not permitted.
- ❗ If work is carried out on a vehicle with an electric drive, the country-specific requirements concerning statutory occupational safety and accident prevention regulations must be observed.

**⚠ WARNING** Risk of accident and injury in the event of improper conversions or changes to the vehicle

Conversions or changes to the vehicle can prevent systems or components from functioning properly and/or jeopardize the vehicle's operational safety.

- ▶ Always have conversions or changes to the vehicle carried out at a qualified workshop.

If you intend to make changes to your vehicle, Mercedes-Benz strongly recommends that you contact the dealer. They will give you all the information you need. There may be a charge for this service.

If body manufacturers and dealers make modifications that affect the final inspection of the engine, vehicle or equipment, they must accept sole responsibility for the vehicle. This also applies to marking and documenting the vehicle parts affected by the changes that they make.

You are responsible for ensuring and providing evidence that the following conditions are met:

- The vehicle complies with all relevant standards and regulations that are affected by the modification.
- The modified vehicle still meets vehicle safety standards and emissions laws and regulations.
- The modification does not impair the safety of the vehicle.



Mercedes-Benz is not responsible for the final inspection, product liability or warranty claims resulting from modification. This applies to the following points:

- The modified components or systems
- The resultant violation of emissions laws and regulations or vehicle safety standards
- All consequences resulting from the modified, less safe or even faulty vehicle

Mercedes-Benz accepts no responsibility as final manufacturer or for the resultant product liability.

#### Notes on the cargo floor

The factory equips the vehicle with a wooden or plastic cargo floor; this is an integral part of the vehicle structure. If you have the cargo floor removed, the vehicle body may be damaged. Load securing will then be impaired and the maximum loading capacity of the tie-down points will no longer be guaranteed. Therefore, do not have the cargo floor removed.

#### Notes on the partition

Without a partition, vehicles that are approved as commercial vehicles (N1, N2) do not fulfill ISO 27956, which describes the equipment for properly securing a load in delivery vehicles. If the vehicle is used to transport goods, retrofitting the partition is strongly recommended, as properly securing the load in vehicles without a partition will always be complex.

### Operator's Manual

This Operator's Manual describes all models, as well as standard and optional equipment of your vehicle that was available at the time of going to press. Country-specific differences are possible. Note that your vehicle may not be equipped with all the functions described. This is also the case for systems and functions relevant to safety. Therefore, your vehicle's equipment may differ from that in the descriptions and illustrations.

The original purchase agreement for your vehicle contains a list of all the systems in your vehicle.

Should you have any questions concerning equipment and operation, consult an authorized Mercedes-Benz Center.

- ⓘ Please bear in mind that all the speed values stated in this Operator's Manual are approximate and are subject to a certain tolerance.

The Operator's Manual and Service Booklet are important documents and should be kept in the vehicle.

#### Note on vehicles that are equipped by body manufacturers

Always observe the body manufacturer's operating instructions. You could otherwise fail to recognize dangers.

### Service and vehicle operation

#### Warranty

The limited warranty for your vehicle is in accordance with the warranty terms and conditions in the Service and Warranty Information booklet.

Your Mercedes-Benz will replace and repair all factory-installed parts in accordance with the terms of the following warranty terms and conditions:

- New Vehicle Limited Warranty
- State Warranty Enforcement Laws ("Lemon Laws")

Replacement parts and accessories are covered by the Mercedes-Benz Parts and Accessories Warranties.

These are available at any Mercedes-Benz.

- ⓘ Should you lose your Service and Warranty Information booklet, have an Mercedes-Benz arrange for a replacement. The new Service and Warranty Information booklet will be posted to you.

#### Vehicle operation outside the USA or Canada

If you drive your vehicle abroad, service points or replacement parts may not be available immediately.

Certain Mercedes-Benz models are available in Europe through the European Delivery Program. Please consult a Mercedes-Benz service center for further information, or write to one of the following addresses:

##### In the USA:

Mercedes-Benz USA, LLC  
One Mercedes-Benz Drive  
Sandy Springs, GA 30328

##### In Canada:

Mercedes-Benz Canada, Inc.  
2680 Matheson Blvd E, Suite 400  
Mississauga, ON L4W 0A5

## Maintenance

Your customer service advisor will record every service for you in the Service and Warranty Information booklet.

## Roadside Assistance

Roadside Assistance offers technical help in the event of a breakdown. Your calls to the toll-free Roadside Assistance Hotline are answered by our agents 24 hours a day, 365 days a year.

1-877-762-8267 (USA)

1-800-387-0100 (Canada)

You can find further information in the Roadside Assistance brochure (USA) or the "Roadside Assistance" section in the Service and Warranty Information booklet (Canada). You will find both in the vehicle document wallet.

## Change of address or change of ownership

In the event of a change of address, please send us the "Notification of Address Change" in the Service and Warranty Information booklet, or simply call the Customer Assistance Center (USA) on the hotline number 1-877-762-8267 or Customer Service (Canada) on 1-800-387-0100. This will give us the opportunity to get in touch with you as soon as possible when necessary.

If you sell your Mercedes, please leave the entire literature in the vehicle so that it is available to the next owner. If you have purchased a used vehicle, please send us the "Notice of Purchase of Used Car" in the Service and Warranty Information booklet or call the Customer Assistance Center (USA) on the hotline number 1-877-762-8267 or Customer Service (Canada) on 1-800-387-0100.

## Possible danger due to substances hazardous to health

In compliance with Proposition 65 ("Prop65"), the following detachable label has been added to each vehicle sold in California:



### WARNING



Operating, servicing and maintaining a passenger vehicle, pickup truck, van or off-road motor vehicle can expose you to chemicals including engine exhaust, carbon monoxide, phthalates, and lead, which are known to the State of California to cause cancer and birth defects or other reproductive harm. To minimize exposure, avoid breathing exhaust, do not idle the engine except as necessary, service your vehicle in a well-ventilated area and wear gloves or wash your hands frequently when servicing your vehicle. For more information go to [www.P65Warnings.ca.gov/passenger-vehicle](http://www.P65Warnings.ca.gov/passenger-vehicle)

A 000 817 82 02

## Operating safety

### **WARNING** Risk of accident due to malfunctions or system failures

If you do not have the prescribed service/maintenance work or any required repairs carried out, this could result in malfunctions or system failures.

- ▶ Always have the prescribed service and maintenance work or any required repairs carried out in a qualified specialist workshop.

### **WARNING** Risk of accident or injury due to incorrect modifications on electronic component parts

Modification of electronic components, their software or wiring could impair their function and/or the function of other networked component parts or safety-relevant systems.

This can endanger the operating safety of the vehicle.

- ▶ Never tamper with the wiring and electronic component parts or their software.
- ▶ You should have all work on electrical and electronic components carried out at a qualified specialist workshop.

Please observe the "Vehicle electronics" section in the "Technical data".

**I NOTE** Damage to the vehicle caused by driving too fast and by blows to the underbody and chassis parts

The vehicle can be damaged in the following cases in particular:

- The underside of the vehicle makes contact with the ground, e.g. on a high curb or an unpaved road.
- The vehicle drives too quickly over an obstacle, e.g. a curb, a speed bump or a pothole.
- A heavy object hits the underbody or chassis components.

In these or similar situations, the vehicle body, the underbody, chassis components, wheels or tires and parts of the high-voltage battery could be damaged even if this is not visible. Components that have been damaged in this way can fail unexpectedly or, in the event of an accident, may not absorb the loads that arise as intended.

- ▶ Have the vehicle checked and repaired immediately at a qualified specialist workshop.

or

- ▶ If driving safety is impaired during the rest of the journey, stop immediately paying attention to the traffic situation and notify a qualified specialist workshop.

An electric vehicle has an electric motor. The electric motor's power supply is provided by the high-voltage on-board electrical system.

**A DANGER** Risk of death and fire due to modified and/or damaged components of the high-voltage on-board electrical system

The vehicle's high-voltage on-board electrical system is under high voltage. If you modify component parts in the vehicle's high-voltage on-board electrical system or touch damaged component parts, you may be electrocuted. In addition, modified and/or damaged components may cause a fire.

In the event of an accident or impact to the underbody, components of the high-voltage electrical system may be damaged although the damage is not visible.

- ▶ Never make any modifications to the high-voltage on-board electrical system.
- ▶ Do not switch on or use the vehicle if its high-voltage on-board electrical system components have been modified or damaged.
- ▶ Never touch damaged components of the high-voltage on-board electrical system.
- ▶ After an accident, do not touch any components of the high-voltage on-board electrical system.
- ▶ After an accident, have the vehicle transported away.
- ▶ Have the components of the high-voltage on-board electrical system checked at a qualified specialist workshop and replaced if necessary.

The components of the vehicle's high-voltage on-board electrical system are marked with yellow warning stickers. The cables of the vehicle's high-voltage on-board electrical system are orange.



Example

High-voltage components that may become very hot are marked with separate warning labels:



Example

Vehicles with an electric motor generate significantly less noise than vehicles with internal combustion engines. As a result, your vehicle may not be heard by other road users in certain situations.

This can occur, for example, when you are parking and your vehicle cannot be seen by other road users. In order to allow for the possibility that other road users may behave incorrectly, adopt a particularly anticipatory driving style.

The vehicle is additionally equipped with a sound generator, which serves as an Acoustic Vehicle Alerting System (AVAS) (→ page 94). This safety system is prescribed by law.

The outside sound produced by the sound generator (AVAS) can be heard in the passenger compartment at low speeds and it is not a malfunction.

### Declarations of conformity and notes on driving in different countries

#### Country-specific information for regulatory radio components

##### Notes when crossing national borders

You must observe the regulatory provisions concerning radio for the country in which you are currently driving when operating the vehicle.



USA: "The wireless devices of this vehicle comply with Part 15 of the FCC Rules. Operation is subject to the following two conditions: 1) These devices may not cause harmful interference, and 2) These devices must accept any interference received, including interference that may cause undesired operation. Changes or modifications not expressly approved by the party responsible for compliance could void the user's authority to operate the equipment."

Canada: "The wireless devices of this vehicle comply with Industry Canada licence-exempt RSS standard(s). Operation is subject to the following two conditions: (1) These devices may not cause interference, and (2) These devices must accept any interference, including interference that may cause undesired operation of the device".

USA: "Wireless charging system for mobile devices (Model: WMI3.5 Wireless Mobile Interface): This Device complies with Part 18 of the FCC Rules."

The name and address of the responsible party is:

Molex CVS  
Mizarstraße 3  
12529 Schönefeld  
Germany

### Diagnostics connection

The diagnostics connection is a technical interface in the vehicle. It is used, for example, during repair and maintenance work or for issuing readouts of vehicle data in a specialist workshop. Diagnostic devices should therefore be connected only in a qualified specialist workshop.

**⚠ WARNING** Risk of accident due to connecting devices to the diagnostics connection

If you connect devices to the diagnostics connection of the vehicle, the function of vehicle systems and operating safety may be impaired.

- ▶ For safety reasons, we recommend that you use and connect only products approved by an authorized Mercedes-Benz Service Center.

**⚠ WARNING** Risk of accident due to objects in the driver's footwell

Objects in the driver's footwell may impede pedal travel or block a depressed pedal.

This will jeopardize the operating- and road safety of the vehicle.

- ▶ Stow all objects in the vehicle securely so that they cannot get into the driver's footwell.
- ▶ Make sure that there is always sufficient clearance for the pedals.
- ▶ Always install the floor mats securely and as prescribed.
- ▶ Do not use loose floor mats and do not place floor mats on top of one another.

**!** **NOTE** Battery discharging from using devices connected to the diagnostics connection

Using devices at the diagnostics connection drains the battery.

- ▶ Check the charge level of the battery.
- ▶ If the charge level is low, charge the battery.

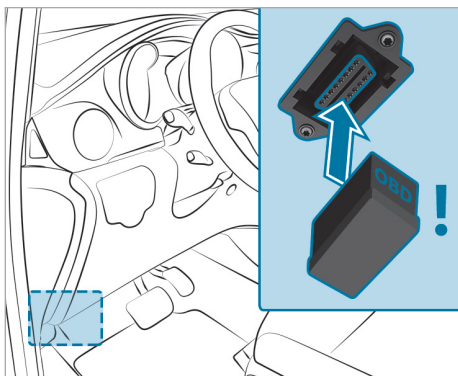

The connection and use of another device on the diagnostics connection can have the following effects:

- Malfunctions in the vehicle system
- Permanent damage to vehicle components

Please refer to the warranty terms and conditions regarding this.

#### Qualified specialist workshop

A qualified specialist workshop has the necessary special skills, tools and qualifications to correctly carry out any necessary work on your vehicle. This particularly applies to work relevant to safety.

Always have the following work on the vehicle carried out at a qualified specialist workshop:

- Safety-relevant works
- Service and maintenance work
- Repair work
- Modifications as well as installations and conversions
- Work on electronic components
- Work on high-voltage components

Mercedes-Benz recommends that you use an Mercedes-Benz for this purpose.

#### Vehicle registration

Mercedes-Benz may ask its service centers to carry out technical inspections on certain vehicles. The quality or safety of the vehicles is improved as a result of the inspection.

Mercedes-Benz can only inform you about vehicle checks if it Mercedes-Benz has your registration data.

In the following cases, your vehicle may not be registered to you yet:

- you did not purchase your vehicle at an authorized specialist dealer.
- your vehicle has not yet been inspected at a Mercedes-Benz Service Center.

It is advisable to register your vehicle with a Mercedes-Benz Service Center.

Inform Mercedes-Benz as soon as possible about any change in address or vehicle ownership.

You can do this at a Mercedes-Benz Service Center, for example.

#### Correct use of the vehicle

If you remove warning stickers, you or others may fail to recognize the dangers. Leave warning stickers in position.

Observe the following information in particular when operating the vehicle:

- Safety notes in these operating instructions
- Technical data for the vehicle
- Traffic rules and regulations of the country in which you are currently located
- Laws pertaining to motor vehicles and safety standards of the country in which you are currently located
- Radio regulations of the country in which you are currently located

#### Multi-purpose vehicle

**⚠ WARNING** Risk of accident when the center of gravity is too high

The vehicle may start to skid and rollover in the event of sudden steering maneuvers and/or when the vehicle's speed is not adapted to the road conditions.

▶ Always adapt your speed and driving style to the vehicle's driving characteristics and to the prevailing road and weather conditions.

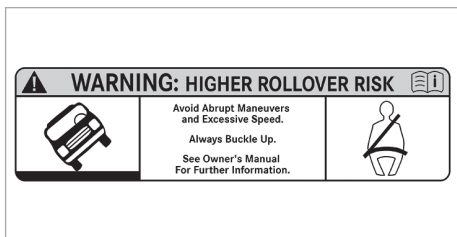

USA

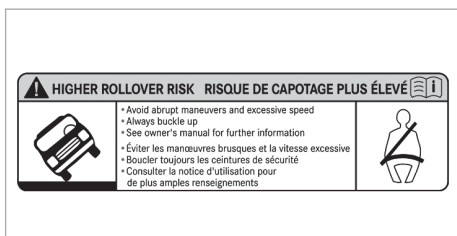

Canada

Utility vehicles have a significantly higher rollover rate than other types of vehicles.

Unsafe operation of the vehicle can result in an accident or rollover, as well as serious or even fatal injuries.

In a rollover crash, an unbelted person is significantly more likely to die than a person wearing a seat belt.

You and all vehicle occupants should always wear seat belts.

#### Notes for persons with electronic medical aids

Despite meticulous development of their vehicle systems, Mercedes-Benz AG cannot completely rule out the interaction of vehicle systems with electronic medical aids, such as cardiac pacemakers.

In addition, there are components built into the vehicle that, regardless of the operating status of your vehicle, can generate magnetic fields on a par with permanent magnets. These fields can be found, for example, in the area around the multimedia and sound system or also in the seating area, depending on the vehicle equipment.

It is therefore possible for the following to occur in isolated cases, depending on the aids used:

- medical aids malfunctioning
- adverse health effects

Observe the notes and warnings of the manufacturer of the medical aids; if in doubt, contact the device manufacturer and/or your doctor. If there is continuing uncertainty concerning the possibility of medical aids malfunctioning, Mercedes-Benz AG recommends using only few electrical vehicle systems and/or maintaining a distance from the components.

When charging the high-voltage battery, keep a distance of at least an arm's length between the medical aid and the following components:

- the power supply equipment
  - This includes charging stations in the form of a wallbox or a public charging point, for example.
- vehicle components carrying live voltage
  - This includes the charging cable and the charging control box, for example.

Have repairs and maintenance work in close proximity to the following components carried out only by a qualified specialist workshop:

- vehicle components carrying live voltage
- transmission aerials
- multimedia system and sound system

If you have any queries or suggestions, consult a qualified specialist workshop.

#### Problems with your vehicle

If you experience a problem with your vehicle, particularly one that you believe may affect vehicle safety, please contact a Mercedes-Benz to have the problem diagnosed and rectified.

If the problem is not resolved to your satisfaction there, please contact a Mercedes-Benz again or write to one of the following addresses.

##### In the USA:

Mercedes-Benz USA, LLC  
Customer Assistance Center  
One Mercedes-Benz Drive  
Sandy Springs, GA 30328

##### In Canada:

Mercedes-Benz Canada, Inc.  
Customer Assistance Center  
2680 Matheson Blvd E, Suite 400  
Mississauga, Ontario L4W 0A5

### "Reporting safety defects"

#### For USA only:

The following text is published as required of manufacturers under Title 49, Code of U.S. Federal Regulations, Part 575 pursuant to the "National Traffic and Motor Vehicle Safety Act of 1966".

If you believe that your vehicle has a defect which could cause a crash or could cause injury or death, you should immediately inform the National Highway Traffic Safety Administration (NHTSA) in addition to notifying Mercedes-Benz Vans, LLC.

If NHTSA receives similar complaints, it may open an investigation, and if it finds that a safety defect exists in a group of vehicles, it may order a recall and remedy campaign. However, NHTSA cannot become involved in individual problems between you, your dealer, or Mercedes-Benz Vans, LLC.

To contact NHTSA, you may call the Vehicle Safety Hotline toll-free at 1-888-327-4236 (TTY: 1-800-424-9153) ; go to <https://www.safercar.gov>; or write to: Administrator, NHTSA, 400 Seventh Street, SW., Washington, DC 20590, USA.

You can find more information on vehicle safety on <https://www.safercar.gov>

#### For Canada only:

The following text is published as required of manufacturers under subsection 18.4 (4) of the Motor Vehicle Safety Regulations.

If you believe that your vehicle has a defect which could cause a crash or could cause injury or death, you should immediately inform Transport Canada in addition to notifying Mercedes-Benz Canada Inc.

If Transport Canada received similar complaints, it may open an investigation, and if it finds that a safety defect exists in a group of vehicles, it may order a recall and remedy campaign. However, Transport Canada cannot become involved in individual problems between you, your dealer, or Mercedes-Benz Canada Inc.

To contact Transport Canada, you may call the Defect Investigations and Recalls Division toll-free in Canada at 1-800-333-0510 or 819-994-3328 in the Gatineau-Ottawa area or internationally; may also go to the following websites for more information:

- English: [www.tc.gc.ca/recalls](http://www.tc.gc.ca/recalls)
- French: [www.tc.gc.ca/rappels](http://www.tc.gc.ca/rappels)

### Limited Warranty

**!** **NOTE** Damage to the vehicle arising from violation of these operating instructions.

Damage to the vehicle can arise from violation of these operating instructions.

Such damage is not covered by either the Limited Warranty or the new or used-vehicle warranty.

► Observe the instructions in these operating instructions on proper operation of your vehicle as well as regarding possible vehicle damage.

### QR codes for rescue card

The QR code stickers are affixed to the B-pillar on the driver's and front passenger side. In the event of an accident, emergency services can use the QR code to quickly determine the corresponding rescue card for your vehicle. The current rescue card contains the most important information about your vehicle in a compact form, e.g. the routing of the electric lines.

Further information is available at: <https://rk.mb-qr.com/de/#rescue-sticker>

### Data storage

#### Data processing in the vehicle

##### Electronic control units

Electronic control units are installed in your vehicle. Control units process data they receive from vehicle sensors, for example, generate themselves or exchange between themselves. Some control units are required for the safe operation of your vehicle. For example, some assist you when driving, such as driver assistance systems, while others enable functions serving comfort or infotainment.

The following provides you with general information regarding data processing in the vehicle. Additional information regarding which data in your vehicle is collected, saved and transmitted to third parties and for what purpose can be found in the information directly related to the functional characteristics in question in the respective Operator's Manual. This information is available both online and digitally, depending on the vehicle's equipment.



### Personal data

A unique vehicle identification number identifies every vehicle. Depending on the country, this vehicle identification number can be used by, for example, governmental authorities to determine the owner's identity. There are other possibilities for using data collected from the vehicle to identify the owner or driver, such as the license plate number.

Therefore, data generated or processed by control units may be attributable to a person or, under certain conditions, become attributable to a person. Depending on which vehicle data are available, it may be possible to make inferences about, for example, your driving behaviour, location, route or use patterns.

### Legal requirements regarding the disclosure of data

If legally required to do so, manufacturers are legally obliged on a case-by-case basis to provide data stored by the manufacturer to governmental entities, upon request and to the extent required. For example, this may come into effect during the investigation of a criminal offense.

Governmental entities are themselves authorised to read out data from the vehicle in individual cases and within the applicable legal framework. Following an accident, information that can help with an investigation can be taken from the air bag control unit, for example.

### Operational data in the vehicle

Data processed by control units for operation of the vehicle.

This includes the following data, for example:

- Vehicle status information such as the speed, longitudinal acceleration, lateral acceleration, number of wheel revolutions or the fastened seat belts display
- Ambient conditions, such as temperature, rain sensor or distance sensor

Generally, these are short-term data and will not be stored beyond the period of operation, and is processed only within the vehicle itself. Control units, for example vehicle keys, often contain data memories. Their use permits the temporary or permanent documentation of technical information regarding the vehicle's operating state, component loads, maintenance requirements and technical events or malfunctions.

Depending on the technical equipment, the following data are stored:

- Operating status of system components, such as fill levels, tire pressure or battery status
- Malfunctions or defects in important system components, such as lights or brakes
- System reactions in special driving situations, such as air bag deployment or the intervention of stability control systems
- Information on events leading to vehicle damage
- State of charge for the high-voltage battery, estimated range

In certain cases, storing data that would have otherwise been temporary may be required. This may be the case if the vehicle has detected a malfunction, for example.

If you use services such as repair services and maintenance work, stored operational data and the vehicle identification number can be read out and used as required. They can be read out from the vehicle by service network employees, such as those working for workshops, manufacturers or third parties (e.g. breakdown services). The same applies for warranty claims and quality assurance measures.

In general, the readout is performed via the legally prescribed port for the diagnostics connection in the vehicle. The operating data read out documents the vehicle's or individual components' technical condition and help to diagnose faults, ensure compliance with warranty obligations and bring about improvements in quality. To that end, this data, and in particular information pertaining to component loads, technical events, malfunctions and other faults may be transmitted along with the vehicle identification number to the manufacturer. Furthermore, the manufacturer is subject to product liability. For this reason, the manufacturer also uses operational data from the vehicle, for example, for recalls. These data can also be used to examine the customer's warranty and legal guarantee claims.

Fault memories in the vehicle can be reset by a service outlet or at your request as part of repair or maintenance work.

### Functions serving comfort and infotainment

You can store the vehicle's settings for comfort and customisations, and can change or reset them at any time.

Depending on the vehicle equipment, this includes the following settings, for example:

- Seat and steering wheel positions
- Suspension tuning and climate control settings
- Customisation settings, such as interior lighting

Depending on the selected equipment, you can import data into vehicle infotainment functions yourself.

Depending on the vehicle equipment, this includes the following data, for example:

- Multimedia data, such as music, films or photos for playback in an integrated multimedia system
- address book data for use in connection with an integrated hands-free system or an integrated navigation system
- entered navigation destinations
- data for the use of Internet services

These data for functions serving comfort and infotainment may be saved locally in the vehicle or on a device connected to the vehicle, such as a smartphone, USB flash drive or MP3 player. Data that you have entered yourself can be deleted at any time.

These data are transmitted only from the vehicle to third parties at your request. This applies in particular when using online services from your own selected settings.

#### **Smartphone integration (e.g. Android Auto or Apple CarPlay®)**

If your vehicle is equipped accordingly, you can connect your smartphone or another mobile end device to the vehicle. You can then control them through the control elements integrated into the vehicle. Images and audio from the smartphone can be relayed through the multimedia system. Certain information is simultaneously transferred to your smartphone. Depending on the type of integration, this includes position data, day/night mode and other general vehicle statuses. For more information, please consult the Operator's Manual for the vehicle or in the infotainment system.

This integration allows the use of selected smartphone apps, such as navigation or music player apps. There is no further interaction between the smartphone and the vehicle; in particular effective access to vehicle data. The type of additional data processing is determined by the provider of the app being used. Permissible settings, if any, will

depend on the specific app and your smartphone's operating system.

#### **Online services**

##### **Wireless network connection**

If your vehicle has a wireless network connection, data can be exchanged between your vehicle and other systems. The wireless network connection is made possible by the vehicle's own transmitter and receiver or by a mobile end device that you have brought into the vehicle, for example, a smartphone. Online functions can be used via this wireless network connection. This includes online services and applications/apps provided to you by the manufacturer or by other providers.

##### **Manufacturer's own services**

Regarding the manufacturer's online services, the individual functions are described by the manufacturer in a suitable place, for example, in the Operator's Manual or on the manufacturer's website, where the relevant data protection information is also given. Personal identification data may be used to provide online services. Data is exchanged via a secure connection, e.g. the manufacturer's designated IT systems. Any personal data which are collected, processed and used, other than for the provision of services, is done so exclusively on the basis of legal permission. This is the case, for example, for a legally prescribed emergency call system, a contractual agreement or when consent has been given.

You can have services and functions, some of which are subject to a fee, activated or deactivated. This excludes legally prescribed functions and services, such as an emergency call system.

##### **Services of third parties**

If you use online services from other providers (third parties), these services are the responsibility of the provider in question and subject to that provider's data protection conditions and terms of use. As a general rule, the manufacturer has no influence on the content exchanged.

For this reason, when services are provided by third parties, please ask the service provider in question for information about the type, extent and purpose of the collection and use of personal data.

##### **Onboard Logic Unit (OLU)**

The Onboard Logic Unit (OLU) is available to commercial customers.

It contains control units, including antennas for connection via wireless networks, that permit the

exchange of data between your vehicle and other systems. The control units can be used in conjunction with service provided by a third party. Under certain circumstances, these services may alter the basic configuration of the vehicle and could affect the performance of certain vehicle functions.

For further information about specific services, read the Operator's Manual of the third-party provider. For further information about the Onboard Logic Unit, consult an authorized Mercedes-Benz Center.

If you, yourself, do not own and are not responsible for the vehicle, you may not know the current status of the Onboard Logic Unit. For further information concerning the services which are currently active, including any data which may be being processed as defined by the GDPR, please contact the person responsible for the vehicle.

### Data protection rights

Depending on the country, the equipment and functions of your vehicle, and the services and service offerings used, you are entitled to different data protection rights. Further information on data protection and your data protection rights can either be found on the manufacturer's website or you will receive this information as part of the various services and service offers. There, you will also find the contact information for the manufacturer and its data protection officer.

At a workshop, for example, with the support of a specialist and possibly for a fee, you can have data read out which is stored only locally in the vehicle.

### Event Data Recorders

#### USA only:

This vehicle is equipped with an event data recorder (EDR). The main purpose of an EDR is to record, in certain crash or near crash-like situations, such as an air bag deployment or hitting a road obstacle, data that will assist in understanding how a vehicle's systems performed. The EDR is designed to record data related to vehicle dynamics and safety systems for a short period of time, typically 30 seconds or less.

The EDR in this vehicle is designed to record such data as:

- How various systems in your vehicle were operating;
- Whether or not the driver and passenger safety belts were buckled/fastened;

- How far (if at all) the driver was depressing the accelerator and/or brake pedal; and,
- How fast the vehicle was traveling.

These data can help provide a better understanding of the circumstances in which crashes and injuries occur. NOTE: EDR data are recorded by your vehicle only if a non-trivial crash situation occurs; no data are recorded by the EDR under normal driving conditions and no personal data (e.g., name, gender, age, and crash location) are recorded. However, other parties, such as law enforcement could combine the EDR data with the type of personally identifying data routinely acquired during a crash investigation.

Access to the vehicle and/or the EDR is needed to read data that is recorded by an EDR, and special equipment is required. In addition to the vehicle manufacturer, other parties that have the special equipment, such as law enforcement, can read the information by accessing the vehicle or the EDR.

EDR data may be used in civil and criminal matters as a tool in accident reconstruction, accident claims, and vehicle safety. Since the Crash Data Retrieval CDR tool that is used to extract data from the EDR is commercially available, Mercedes-Benz Vans, LLC („MBV“) expressly disclaims any and all liability arising from the extraction of this information by unauthorized Mercedes-Benz personnel.

MBV will not share EDR data with others without the consent of the vehicle owners or, if the vehicle is leased, without the consent of the lessee. Exceptions to this representation include responses to subpoenas by law enforcement; by federal, state or local government; in connection with or arising out of litigation involving MBV or its subsidiaries and affiliates; or, as required by law.

Warning: The EDR is a component of the Restraint System Module. Tampering with, altering, modifying or removing the EDR component may result in a malfunction of the Restraint System Module and other systems.

State laws or regulations regarding EDRs that conflict with federal regulation are pre-empted. This means that in the event of such conflict, the federal regulation governs. As of February 2013, 13 states have enacted laws relating to EDRs.

### Copyright

#### Free and open source software

Information on licenses for free and open-source software used in your vehicle can be found on the

data storage medium in your vehicle document wallet and with latest updates on the following website:

<https://www.mercedes-benz.com/opensource>

### Registered trademarks



---

- Bluetooth® is a registered trademark of Bluetooth SIG Inc.
- DTS™ is a registered trademark of DTS, Inc.
- Dolby® and MLP™ are registered trademarks of DOLBY Laboratories.
- ESP® and PRE-SAFE® are registered trademarks of Mercedes-Benz Group AG.
- HomeLink® is a registered trademark of Genex Corporation.
- iPod® and iTunes® are registered trademarks of Apple Inc.
- Burmester® is a registered trademark of Burmester Audiosysteme GmbH.
- Microsoft® and Windows Media® are registered trademarks of Microsoft Corporation.
- SiriusXM® is a registered trademark of Sirius XM Radio Inc.
- HD Radio™ is a registered trademark of iBiquity Digital Corporation.
- Gracenote® is a registered trademark of Gracenote, Inc.
- ZAGAT Survey® and related brands are registered trademarks of Zagat Survey, LLC.

## Brief overview of most important points

### Basic information

Make sure that the following prerequisites in particular have been met, so that the components of the restraint system are able to provide the intended level of protection:

- Sit correctly (→ page 27).
- Fasten the seat belt correctly (→ page 28).
  - Function of the  seat belt warning lamp (→ page 29).
- The  restraint system warning lamp has not gone out after the self-test (→ page 29).

### For clear understanding

The chapter "Occupant safety" includes information on equipment, functions and behaviors that contribute directly to safety of vehicle occupants.

The information is structured as follows:

- **The most important information in brief:** in this chapter, you are provided with an overview of the relationship between the restraint system and the correct behavior of all vehicle occupants.
- **Specific information:** in further sections of the chapter "Occupant safety", you can find specific information on the equipment and functions of the restraint system.
- **Keyword directory:** you can also find certain subjects in this Operator's Manual using the keyword directory.

Information on the following subjects, among others, is not provided in the chapter "Occupant safety":

- Children in the vehicle (→ page 35)
- Driving and driving safety systems (→ page 118)
- Stowage areas (→ page 164)

### Defining generic terms clearly

In this Operator's Manual, the following generic terms are used:

- **Occupant safety:** comprises the components and system functions which help to minimize, as much as possible, the stresses and consequences for vehicle occupants during an accident.
- **Restraint system:** comprises those components which, along with the vehicle structure, help prevent vehicle occupants from potentially

coming into contact with parts of the vehicle interior. The seat belts and air bags, for example, are components of the restraint system.

- **Child restraint system:** you can find all information on this subject in the chapter "Children in the vehicle" (→ page 35).

### Be diligent

For the components of the restraint system to provide the intended level of protection, it is essential that you are seated correctly and that the seat belt is correctly secured.

Bear in mind that negligence when adjusting your sitting position and fastening the seat belt can have serious consequences. Be diligent and make sure before starting every journey that all vehicle occupants are sitting correctly and have fastened their seat belts properly.

### Information on the correct seat position

The seat position must be correct in order for the components of the restraint system to provide the intended level of protection.

The seat position influences both the protection provided by the seat belt and the additional protection provided by the air bag.

A correct seat position in which the seat is nearly perfectly upright and a correctly fastened seat belt reduce the risks posed by the air bag when it is deployed.

#### **WARNING** Risk of injury or death due to an incorrect seat position

If you deviate from the correct seat position, the air bag cannot provide its intended protective function.

Each vehicle occupant must make sure of the following.

- ▶ Put the seat in the correct position.
- ▶ Fasten seat belts correctly. Pregnant women must take particular care to ensure that the lap belt never lies across the abdomen.
- ▶ Observe the following information.

In order for the restraint system to provide the intended level of protection, observe the following information:

- Before starting your journey, adjust your seat correctly (→ page 56).

When doing so, make sure you are able to fasten your seat belt correctly. The shoulder belt strap must be routed forward from the seat belt outlet over the center of your shoulder.

- Keep your distance from the air bags, especially the front air bags. Set the driver's seat and co-driver seat as far back as possible while making sure the seat belt is fastened correctly.
- Make sure there are no people, animals or objects between the vehicle occupants and an air bag.
- If you are the driver, observe the following information on the correct position of the driver's seat (→ page 56).

Hold the steering wheel only by the steering wheel rim. This allows the driver's air bag to fully deploy.

- Assume a nearly upright sitting posture, with your buttocks positioned as far back as possible in the gap between the seat cushion and the seat backrest.

Your back must lie as flatly and as firmly as possible against the seat backrest.

- While driving, do not lean forward and do not lean against the door or side window. You may otherwise be in the deployment area of the air bags.
- Sit with their feet resting on the floor, if possible. Your thighs are slightly supported by the seat cushion.

Do not put your feet on the cockpit, for example. Your feet may otherwise be in the deployment area of the air bag.

- Fasten the seat belt correctly.

### Notes on wearing the seat belt correctly

Always fasten your seat belt correctly before starting a journey. Only a seat belt that is worn correctly can provide the intended level of protection.

**⚠ WARNING** Risk of injury or death due to incorrectly fastened seat belt

If the seat belt is not worn correctly, it cannot perform its intended protective function.

In addition, an incorrectly fastened seat belt can also cause injuries, for example, in the event of an accident or when braking or changing direction suddenly.

▶ Always ensure that all vehicle occupants have their seat belts fastened correctly and are sitting properly.

**⚠ WARNING** Risk of injury or death when additional restraint systems are not used for persons with a smaller stature

Persons under 5 ft (1.50 m) tall cannot wear the seat belt correctly without a suitable additional restraint system.

▶ Always secure persons under 5 ft (1.50 m) tall in a suitable restraint system.

Each vehicle occupant must observe the following notes in particular:

- The seat belt must not be twisted.
- The shoulder belt strap must be routed forward from the seat belt outlet over the center of your shoulder.
- The shoulder belt strap should neither touch your neck nor be routed under your arm or behind your back.
- The lap belt must be routed as low down across the hips as possible.

In addition, push the lap belt down as far as possible across your hips and pull tight with the shoulder belt strap. Never route the lap belt across your abdomen.

Pregnant women must also take particular care with this.

- After being tightened, the shoulder belt strap and lap belt must fit snugly against the body.
- Avoid wearing bulky clothing, e.g. a winter coat.
- Never route the seat belt across sharp, pointed, abrasive or fragile objects.
- Only one person should use each seat belt at any one time.
- Never secure objects with a seat belt if the seat belt is being used by one of the vehicle's occupants.

Also ensure that no objects, e.g. a cushion, are ever placed between a person and the seat.

### Fastening and adjusting seat belts

If the seat belt is pulled quickly or sharply, the seat belt retractor locks. The seat belt strap cannot be pulled out any further.

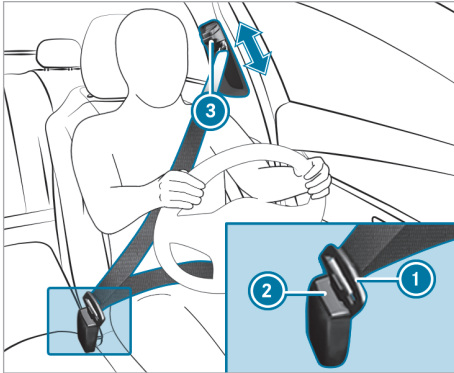

- ▶ Always engage the seat belt tongue ① of the seat belt into the seat belt buckle ② of the corresponding seat.
- ▶ **To adjust the seat belt height:** press button ③ on the seat belt outlet and slide the seat belt outlet to the desired position.
- ▶ **To engage the seat belt outlet:** release button ③ and ensure that the seat belt outlet engages.

**!** **NOTE** Deployment of components of the restraint system when the front passenger seat is unoccupied and a seat belt is buckled

When the front passenger seat is unoccupied and the seat belt tongue of the seat belt is engaged in the seat belt buckle, components of the restraint system may deploy unnecessarily on the front passenger side, e.g. the Emergency Tensioning Device.



- ▶ Only buckle the seat belts as intended.

**i** Observe the information on the special seat belt retractor of the seat belt (→ page 37).

### Function of the restraint system warning lamp

When the vehicle is switched on, a self-test is performed, during which the restraint system warning lamp  lights up. It goes out no later than a few seconds after the vehicle is started. The components of the restraint system are then functional.

A malfunction has occurred in the restraint system in the following cases:

- The restraint system warning lamp  does not light up or lights up continuously when the vehicle is switched on.
- The restraint system warning lamp  lights up continuously or repeatedly during a journey.

If components of the restraint system have been deployed, the restraint system warning lamp  lights up continuously.

**!** **WARNING** Risk of injury due to malfunctions in the restraint system

Components in the restraint system may be activated unintentionally or not deploy as planned in an accident.

- ▶ Have the restraint system checked and repaired immediately at a qualified specialist workshop.

If the restraint system is malfunctioning, the automatic high-voltage emergency shutoff may not function.

**!** **DANGER** Risk of fatal injuries due to malfunctions of the automatic high-voltage emergency shutoff

In the event of an accident, the high-voltage on-board electrical system may not be deactivated as intended.

You may be electrocuted if you touch the damaged component parts of the high-voltage on-board electrical system.

- ▶ Have the automatic high-voltage emergency shutoff checked and repaired immediately at a qualified specialist workshop.
- ▶ After an accident, switch off the vehicle immediately.

Mercedes-Benz recommends that you have the vehicle towed to a qualified specialist workshop.

### Function of the seat belt warning lamp

The  seat belt warning lamp in the instrument cluster display reminds you that all vehicle occupants must fasten their seat belts correctly.

The  seat belt warning lamp lights up for six seconds each time the vehicle is switched on.

A warning tone may also sound.



After the vehicle is started, the seat belt warning goes out as soon as the driver's and the front passenger's seat belts are fastened.

While driving, the seat belt warning lights up in the following cases:

- if the vehicle's speed is higher than 15 mph (25 km/h) and the driver's or front passenger's seat belt is not fastened
- if the driver or front passenger unfastens their seat belt during the journey

### Information on the child restraint system

When installing a child restraint system, observe the notes in "Children in the vehicle" (→ page 35).

### Notes on the child restraint system on the front passenger seat

**⚠ WARNING** Risk of injury or fatal injuries if the front passenger air bag is enabled

If the front passenger air bag is enabled, a child on the front passenger seat may be struck by the front passenger air bag in the event of an accident.

- ▶ NEVER use a rearward-facing child restraint system on a seat with an ENABLED FRONT AIR BAG. This can result in the DEATH of or SERIOUS INJURY to the CHILD.

Also pay particular attention to the notes on rearward-facing or forward-facing child restraint systems on the front passenger seat (→ page 37).

### Information on the automatic functions of the restraint system

#### Overview of the automatic measures after an accident

Depending on the type and severity of the accident, and depending on the vehicle's equipment, the following measures can be implemented, for example:

- automatic braking (post-collision brake)
- activating the hazard warning lights
- triggering an automatic emergency call (→ page 179)
- switching off the drive system and high-voltage on-board electrical system

- unlocking the vehicle doors
- lowering the front side windows
- switching on the interior lighting

#### Function of the post-collision brake after an accident

##### Function of the post-collision brake

Depending on the accident situation, the post-collision brake can minimize the severity of a further collision or even avoid it.

If an accident has been detected, the post-collision brake can implement automatic braking. When the vehicle has come to a standstill, the electric parking brake is automatically applied.

The driver can cancel automatic braking by taking the following actions:

- braking more strongly than automatic braking
- fully depressing the accelerator pedal with force

#### Purpose and function of the restraint system

##### Overview of deployment situations (restraint system)

Make sure that the following prerequisites in particular have been met, so that the components of the restraint system are able to provide the intended level of protection:

- Sit correctly (→ page 27).
- Fasten the seat belt correctly (→ page 28).
  - Function of the seat belt warning lamp (→ page 29) .
- The  restraint system warning lamp is not on after the self-test (→ page 29).

Depending on the detected deployment situation, the components of the restraint system can be activated or deployed independently of one another:

- Emergency Tensioning Device: frontal impact, rear impact, side impact, overturning, rollover
- Driver's air bag, front passenger air bag: frontal impact
- Side air bag: side impact
- Window air bag: side impact, overturning, rollover, frontal impact

The installation location of an air bag is identified by the symbol AIRBAG (→ page 34).

Observe the information on the function of the restraint system (→ page 31).

### Information on how the restraint system works

How the restraint system functions depends on the severity of the impact detected and the apparent type of accident.

For more information about types of accidents, see "Overview of deployment situations" (→ page 30).

The activation thresholds for the components of the restraint system are determined based on the evaluation of the sensor values measured at various points in the vehicle. This process is pre-emptive in nature. The triggering/deployment of the components of the restraint system must take place in good time at the start of the collision.

Factors that can be seen and measured only after a collision has occurred do not play a decisive role in the deployment of an air bag, nor do they provide an indication of air bag deployment.

The vehicle may be deformed significantly without an air bag being deployed. This is the case if only parts that are relatively easily deformed are affected and the rate of vehicle deceleration is not high. Conversely, an air bag may be deployed even though the vehicle suffers only minor deformation. If very rigid vehicle parts, such as longitudinal members, are hit, the vehicle deceleration may be high enough for this to happen.

Depending on the apparent type of accident and the detected deployment situation, Emergency Tensioning Devices and/or air bags supplement the protection offered by a correctly worn seat belt.

Vehicles with a front passenger bench seat: the Emergency Tensioning Device on the front passenger seat is triggered whether or not the seat belt tongue is engaged in the seat belt buckle.

When enabled, an air bag can provide additional protection for the respective vehicle occupant.

Possible protection per air bag:

- Driver's air bag, front passenger air bag: head and ribcage
- Window curtain air bag: head
- Side impact air bag: ribcage and pelvis

However, no system available today can completely eliminate injuries and fatalities in every accident situation. In particular, the seat belt and air bag generally do not protect against objects penetrat-

ing the vehicle from the outside. It is also not possible to completely rule out the risk of injury caused by the air bag deploying.

Mercedes-Benz recommends that you have the vehicle towed to a qualified specialist workshop after an accident. Take this into account, particularly if a Emergency Tensioning Device is triggered or an air bag deployed.

If the Emergency Tensioning Devices are triggered or an air bag is deployed, you will hear a bang, and a small amount of powder may also be released:

- The bang will not generally affect your hearing.
- In general, the powder released is not hazardous to health but may cause short-term breathing difficulties to persons suffering from asthma or other pulmonary conditions.

Provided it is safe to do so, leave the vehicle immediately or open the window in order to prevent breathing difficulties.

Air bags and pyrotechnic Emergency Tensioning Devices contain perchlorate material, which may require special handling or environmental protection measures. National guidelines regarding waste disposal must be observed. In California see <https://dtsc.ca.gov/>. You can use the search function to find information on perchlorate, for example.

### Information on the limited protection provided by the restraint system

#### ■ Risk due to incorrect behavior by vehicle occupants

Every vehicle occupant must make sure of the following in particular:

- They observe the information on the correct seat position (→ page 27).
- There are no heavy, sharp-edged or fragile objects in the pockets of their clothing. Store such objects in a suitable place.

#### **▲ WARNING** Risk of injury or death due to an incorrect seat position

The seat belt does not offer the intended level of protection if you have not moved the seat backrest to an almost vertical position.

In particular, you could slip beneath the seat-belt and become injured.

- ▶ Adjust the seat properly before beginning your journey.

- ▶ Always ensure that the seat backrest is in an almost vertical position and that the shoulder belt is routed across the center of your shoulder.

### Risk due to objects in the vehicle interior

Every vehicle occupant must make sure of the following in particular:

- They observe the information on the correct seat position (→ page 27).
- There are no objects between the seat, door and door pillar (B-pillar).
- There are no hard objects, e.g. coat hangers, hanging on the grab handles or coat hooks.
- There are no heavy, sharp-edged or fragile objects in the pockets of your clothing. Store such objects in a suitable place.

**⚠ WARNING** Risk of injury or death due to blocked seat belt buckle or seat belt anchorage

Objects next to the front seat that block the seat belt buckle or the moving seat belt anchorage on the front seat impair the function of the Emergency Tensioning Devices.

- ▶ Before starting the journey, make sure that there are no objects around the seat belt buckle or between the front seat and door.

**⚠ WARNING** Risk of injury from objects in the deployment area of an airbag

Objects in the deployment area of an airbag can hinder or prevent the correct deployment of the airbag.

The airbag may then deploy in an uncontrolled manner and may even cause additional injuries to the vehicle occupants by deploying. This may be the case in particular if the airbag is integrated into the seat.

- ▶ Always stow and secure objects correctly.
- ▶ Before commencing your journey, make sure that no objects are stowed in the deployment area of an airbag.

The installation location of an air bag is identified by the AIRBAG symbol (→ page 34).

### Risk due to installation of accessories

Do not attach accessories such as mobile navigation devices, mobile phones or cup holders within the deployment area of an air bag, e.g. on the cockpit, on the door, on the side window or on the side trim.

In addition, no connecting cables, tensioning straps or retaining straps may be routed or attached to the vehicle within the deployment area of an air bag. Always comply with the accessory manufacturer's installation instructions and, in particular, the notes on suitable places for installation.

**⚠ WARNING** Risk of injury or death due to unsuitable protective covers

Unsuitable protective covers mean that air bags can no longer protect vehicle occupants as they are designed to do.

- ▶ Use only protective covers approved by Mercedes-Benz for the seat in question.

### Risk due to pets in the vehicle interior

**⚠ WARNING** Risk of accident and injury due to animals left unsecured or unattended in the vehicle

If you leave animals in the vehicle unattended or unsecured, they could possibly press buttons or switches.

An animal may:

- Activate vehicle equipment and become trapped, for example
- Switch systems on or off and endanger other road users

Unsecured animals may be thrown around in the vehicle in the event of an accident or sudden steering and braking maneuvers and injure vehicle occupants in the process.

- ▶ Never leave animals in the vehicle unattended.
- ▶ Always correctly secure animals while driving, e.g. using a suitable animal carrier.

### Risk due to modification, damage or wear to the components of the restraint system

**⚠ WARNING** Risk of injury or death due to modifications to the restraint system

Vehicle occupants may no longer be protected as intended if alterations are made to the restraint system.

- ▶ Never alter the parts of the restraint system.
- ▶ Never tamper with the wiring or any electronic component parts or their software.

If it is necessary to adjust the vehicle to accommodate a person with physical disabilities, contact an authorized Mercedes-Benz Center for details.

USA only: for further information contact our Customer Assistance Center at 1-800-FOR-MERCEDES (1-800-367-6372).

**⚠ WARNING** Risk of injury or death due to damaged or modified seat belts

Seat belts cannot provide protection in the following situations:

- The seat belt is damaged, has been modified, is extremely dirty, bleached or dyed
- The seat belt buckle is damaged or extremely dirty
- Modifications have been made to the Emergency Tensioning Device, seat belt anchorage or seat belt retractor

Seat belts may sustain non-visible damage in an accident, e.g. due to glass splinters.

Modified or damaged seat belts could tear or fail in the event of an accident, for example.

Modified Emergency Tensioning Devices could accidentally trigger or fail to function as intended.

- ▶ Never modify the seat belt system, for example the seat belt, seat belt buckle, Emergency Tensioning Device, seat belt anchorage and seat belt retractor.
- ▶ Make sure that the seat belts are undamaged, not worn and clean.
- ▶ Always have the seat belts checked immediately after an accident at a qualified specialist workshop.

Only use seat belts which have been approved for your vehicle by Mercedes-Benz.

**⚠ WARNING** Risk of injury due to modifications to the cover of an airbag

If you change the cover of an airbag or attach objects, e.g. even stickers, to it, the airbag may no longer function as intended.

- ▶ Never modify the cover of an airbag.
- ▶ Do not attach any objects to the cover.

The installation location of an air bag is identified by the air bag symbol (→ page 34).

**⚠ WARNING** Risk of injury due to malfunctioning sensors in the door

The function of the airbags can be impaired due to modifications or incorrect work performed on the doors or door trim, or if the doors are damaged.

- ▶ Never modify the doors or parts of the doors.
- ▶ Always have work on the doors or door trim carried out at a qualified specialist workshop.

### Risk due to components of the restraint system that have already been deployed

Mercedes-Benz recommends that you have the vehicle towed to a qualified specialist workshop after an accident.

**⚠ WARNING** Risk of burns from hot air bag components

The air bag parts are hot after an air bag has been deployed.

- ▶ Do not touch the air bag parts.
- ▶ Have a deployed air bag replaced at a qualified specialist workshop as soon as possible.

**⚠ WARNING** Risk of injury due to deployed airbag

A deployed airbag no longer offers any protection.

- ▶ Have the vehicle towed to a qualified specialist workshop in order to have the deployed airbag replaced.

Have deployed air bags replaced immediately.

**⚠ WARNING** Risk of injury or death from deployed pyrotechnic Emergency Tensioning Devices

Pyrotechnic Emergency Tensioning Devices that have been deployed are no longer operational and are unable to perform their intended protective function.

- ▶ Therefore, have deployed pyrotechnic Emergency Tensioning Devices immediately replaced at a qualified specialist workshop.

## Seat belts

### Unfastening the seat belts

- ▶ Press the release button on the seat belt buckle and guide the seat belt back with the seat belt tongue.

**! NOTE** Damage caused by trapping the seat belt

If an unused seat belt is not fully retracted, it may become trapped in the door or in the seat mechanism.

- ▶ Always ensure that an unused seat belt is fully retracted.

## Airbags

### Overview of air bags

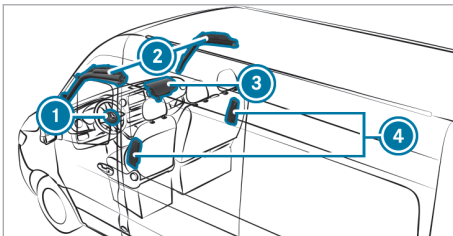

- ① Driver's air bag
- ② Window curtain air bag
- ③ Co-driver air bag
- ④ Side impact air bag

The installation location of an air bag is identified by the AIRBAG symbol.

Observe the information in "Overview of deployment situations" (→ page 30).

## Brief overview of most important points

### Carrying children safely in the vehicle

Always observe the following when carrying children:

- Never leave children unattended in the vehicle (→ page 35).
- Secure children of less than 5 ft (1.50 m) in height or under 12 years of age properly in the appropriate seat with a suitable and approved child restraint system and secure infants in a rear-facing child restraint system.
- Observe the child restraint system manufacturer's installation instructions.

### Front passenger seat

Attachment system:



Seat belt on vehicle seat (→ page 38)

## Important safety notes

### Basic information

#### Be diligent

Bear in mind that negligence when securing a child in the child restraint system can have serious consequences. Always be diligent and secure a child carefully before each journey.

Infants and children must never travel sitting on the lap of a vehicle occupant.

To improve protection for children under 12 years of age or less than 5 ft (1.50 m) in height, Mercedes-Benz recommends that you make sure you observe the following information:

- Always secure the child in a child restraint system suitable for this Mercedes-Benz vehicle.
- The child restraint system must be appropriate to the age, weight and size of the child.
- The vehicle seat must be suitable for the child restraint system to be installed:

#### The generic term child restraint system

The generic term child restraint system is used in this Operator's Manual. A child restraint system can be e.g.:

- an infant carrier
- a rear-facing child seat

- a front-facing child seat
- a child booster seat – Mercedes-Benz recommends using a child booster seat **with** a seat backrest and seat belt guide

#### Observe laws and regulations

Always observe the legal requirements when using a child restraint system in the vehicle.

#### Securing systems for child restraint systems in the vehicle

Only use the following securing systems for child restraint systems:

- the seat belt system of the vehicle

A booster seat may be necessary to achieve proper seat belt positioning for children over 40 lbs (18 kg) in weight or until they reach a height where a three-point seat belt can be installed properly without a booster seat.

Mercedes-Benz recommends a child booster seat with a backrest and seat belt guides.

#### Observe standards for child restraint systems

All child restraint systems must meet the following standards:

- U.S. Federal Motor Vehicle Safety Standards 213
- Canadian Motor Vehicle Safety Standards 213

Confirmation that the child restraint system complies with the standards can be found on an information label on the child restraint system. This confirmation can also be found in the installation instructions that are included with the child restraint system.

### Important warning notices

#### Always secure a child restraint system correctly



**WARNING** Risk of injury or death due to incorrect installation of the child restraint system

The child can then not be protected or restrained as intended.

- ▶ Be sure to comply with the manufacturer's installation instructions for the child restraint system and its correct use.
- ▶ Make sure that the entire base of the child restraint system always rests on the sitting surface of the seat.

- ▶ Never place objects (e.g. cushions) under or behind the child restraint system.
- ▶ Use child restraint systems only with the original cover designed for them.
- ▶ Always replace damaged covers with genuine covers.

- Always observe the vehicle-specific information.
  - Securing a child restraint system with the seat belt (→ page 38).
- Observe the warning labels in the vehicle interior and on the child restraint system.

**⚠ WARNING** Risk of injury or death due to unsecured child restraint systems in the vehicle

If the child restraint system is incorrectly mounted or unsecured, it may come loose.

The child can then not be protected or restrained as intended.

Unused child restraint systems could be flung around and hit vehicle occupants.

- ▶ Always comply with the manufacturer's installation instructions for the child restraint system and its correct use.
- ▶ Always fit child restraint systems correctly, even if they are transported in the vehicle unused.

#### Do not modify the child restraint system

**⚠ WARNING** Risk of injury due to modifications to the child restraint system

The child restraint system can no longer function properly. This poses an increased risk of injury.

- ▶ Never modify a child restraint system.
- ▶ Only affix accessories which have been specially approved for this child restraint system by the child restraint system's manufacturer.

#### Only use child restraint systems which are in proper working condition

**⚠ WARNING** Risk of injury or death caused by the use of damaged child restraint systems

Child restraint systems or their retaining systems that have been subjected to stress in an accident may not be able to perform their intended protective function.

It may be the case that the child cannot be properly restrained.

- ▶ Always immediately replace child restraint systems that have been damaged or involved in an accident.
- ▶ Have the securing systems for the child restraint systems checked at a qualified specialist workshop before installing a child restraint system again.

#### Avoid direct sunlight

**⚠ WARNING** Risk of burns when the child seat is exposed to direct sunlight

If the child restraint system is exposed to direct sunlight or heat, parts could heat up excessively.

Children could suffer burns from these parts, particularly the metallic parts of the child restraint system.

- ▶ Always make sure that the child restraint system is not exposed to direct sunlight.
- ▶ Cover the child restraint system with a blanket, for example.
- ▶ If the child restraint system has been exposed to direct sunlight, allow it to cool before securing a child into it.
- ▶ Never leave children unattended in the vehicle.

#### Observe when stopping or parking

**⚠ WARNING** Risk of fatal injury due to exposure to extreme heat or cold in the vehicle

If persons, particularly children, are subjected to prolonged exposure to intense heat or cold, there is a risk of severe injury or even death.

- ▶ Never leave persons, particularly children, unattended in the vehicle.



**⚠ WARNING** Risk of accident and injury due to children left unattended in the vehicle

If you leave children unattended in the vehicle, they could, in particular:

- open doors, thereby endangering other persons or road users.
- get out and be struck by oncoming traffic.
- operate vehicle equipment and become trapped, for example.

In addition, the children could also set the vehicle in motion by, for example:

- releasing the parking brake.
- changing the gearbox position.
- starting the vehicle.

- ▶ Never leave children unattended in the vehicle.
- ▶ When leaving the vehicle, always take the key with you and lock the vehicle.
- ▶ Keep the key out of reach of children.

#### Notes on rearward-facing child restraint systems on the front passenger seat

The front passenger air bag cannot be deactivated. Never install a rearward-facing child restraint system on the front passenger seat. Observe the manufacturer's installation and operating instructions for the child restraint system.

#### Securing the child restraint system

##### Adjusting the seat correctly

**🔧** Depending on the vehicle equipment, always observe the following when installing a belt-secured child restraint system on the front passenger seat:

- ▶ **When using a front-facing child restraint system with integrated child seat belt:** remove the head restraint from the respective seat, if possible. After the child restraint system has been removed, immediately replace the head restraint and adjust correctly.
- ▶ The backrest of the front-facing child restraint system must, as far as possible, be resting against the seat backrest of the front passenger seat.

- ▶ Do not wedge the child restraint system between the roof and the seat surface and/or install it facing the wrong direction.
- ▶ Adjust the vehicle head restraints so that the child restraint system is not put under strain by the head restraint.
- ▶ Never place objects (e.g. cushions) under or behind the child restraint system.
- ▶ Set the front passenger seat as far back as possible and move the seat into the highest position possible. Always make sure that the shoulder belt strap is correctly routed from the seat belt outlet of the vehicle to the shoulder belt guide on the child restraint system. The shoulder belt strap must be routed forwards from the seat belt outlet and, where possible, downwards to the child restraint system.
- ▶ Fully retract the seat cushion length adjustment.
- ▶ Set the seat cushion inclination in such a way that the front edge of the seat cushion is in the highest position and the rear edge of the seat cushion is in the lowest position.
- ▶ Set the seat backrest to the most vertical position possible.

#### Activating or deactivating the special seat belt retractor

**⚠ WARNING** Risk of injury or death if a seat belt is unfastened while the vehicle is in motion

If the seat belt is released while the vehicle is in motion, the special seat belt retractor is deactivated and the child restraint system is no longer correctly secured. The seat belt is drawn in slightly by the inertia reel and cannot be immediately closed again.

- ▶ Stop the vehicle immediately in accordance with the traffic conditions.
- ▶ Activate the special seat belt retractor again and correctly secure the child restraint system.

When activated, the special seat belt retractor ensures that the seat belts of the front passenger seat do not slacken once the child restraint system is secured.

The seat belts on the following seats are equipped with a special seat belt retractor:

- Front passenger seat

#### Installing a child restraint system

- ▶ When installing a child restraint system, always observe the manufacturer's installation and operating instructions for the child restraint system used, as well as the notes in this Operator's Manual.
- ▶ Pull the seat belt smoothly from the seat belt outlet.
- ▶ Engage the seat belt tongue in the seat belt buckle.

#### Activating the special seat belt retractor

- ▶ Extend the seat belt fully and then allow the inertia reel to retract the belt. When the special seat belt retractor is activated, you should hear a ratcheting sound.
- ▶ Push the child restraint system down until the seat belt is tight.

#### Deactivating the special seat belt retractor

- ▶ Press the release button of the seat belt buckle.
- ▶ Hold the seat belt tongue and guide it back to the seat belt outlet.

#### Securing the child restraint system with the seat belt

The seat belts on the following seats are equipped with a child seat safety feature:

- Front passenger seat

When enabled, the child seat safety feature ensures that the seat belts of the front passenger seat do not slacken once the child restraint system is secured.

- ▶ Install the child restraint system. The entire base of the child restraint system must always rest on the sitting surface of the seat.
- ▶ Always make sure that the shoulder belt strap is correctly routed from the seat belt outlet of the vehicle to the shoulder belt guide on the child restraint system. The shoulder belt strap must be routed forwards from the seat belt outlet and, where possible, downwards to the child restraint system.

- ▶ If necessary, adjust the seat belt outlet and the front passenger seat as appropriate.

**SmartKey**

**Notes on radio connections of the key**

**⚠ DANGER** Risk of fatal injury to persons with medical devices due to electromagnetic radiation when using the start/stop button

Persons with medical devices, e.g. pacemakers or defibrillators:

There is a radio connection between the key and the vehicle.

The function of a medical device can be impaired.

- ▶ Before operating the vehicle, consult your doctor or the manufacturer of the medical device about any possible effects from such systems.

**Detection range of the KEYLESS-START function antenna**

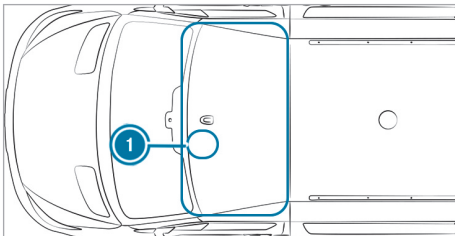

- ① Position of the key holder when the detection range of the antenna is reduced

**Overview of SmartKey functions**

**⚠ WARNING** Risk of accident and injury if children are left unattended in the vehicle

If children are left unattended in the vehicle, they could in particular:

- open doors, thereby endangering other persons or road users.
- get out and be struck by oncoming traffic.
- operate vehicle equipment and become trapped, for example.

In addition, the children could also set the vehicle in motion, for example by:

- releasing the parking brake.
  - changing gear.
  - starting the vehicle.
- ▶ Never leave children unattended in the vehicle.
  - ▶ When leaving the vehicle, always take the SmartKey with you and lock the vehicle.
  - ▶ Keep the SmartKey out of the reach of children.

**⚠ NOTE** Damage to the SmartKey caused by magnetic fields

- ▶ Keep the SmartKey away from strong magnetic fields.

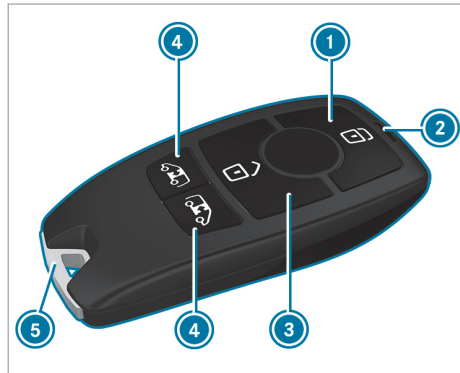



- ① To lock
- ② Battery indicator light
- ③ To unlock
- ④ To unlock the cargo compartment (sliding doors and rear-end doors)/to unlock and open/close the electric sliding doors
- ⑤ Emergency key

The SmartKey's factory setting enables you to centrally lock and unlock the following components:

- The driver's and front passenger door
- The sliding doors
- The rear-end doors

**i** If you do not open the vehicle within approximately 40 seconds of unlocking it, the vehicle will lock again and anti-theft protection will be armed again.

Do not keep the SmartKey together with electronic devices or metallic objects. This can affect the SmartKey's functionality.

- ❗ If the indicator lamp does not light up when you press the  or  button, the battery is discharged.

Replace the SmartKey battery (→ page 40).

### Activating/deactivating the acoustic locking verification signal

Multimedia system:

→  >> Settings >> Vehicle



>> Open/Close

- ▶ Switch the **Acoustic Lock** on or off.

### Changing the unlocking settings

The key has the following adjustable unlocking functions:

- unlock the vehicle centrally
- unlock the driver's door (vehicles without partition or with cab)
- unlock the driver's door and front passenger door (vehicles with partition)



- ▶ **To switch between settings:** press and hold the  and  buttons at the same time for approximately six seconds until the indicator lamp flashes twice.

- ▶ **To unlock the vehicle centrally when the unlocking function is selected for the driver's door or the driver's and front passenger door:** press the  button a second time.

### Reducing the energy consumption of the SmartKey

#### Deactivating SmartKey function

If you do not use the vehicle or a SmartKey for an extended period of time, you can also deactivate the function of the SmartKey to reduce its energy consumption.

- ▶ Press and hold the  button on the SmartKey.
- ▶ With the  button held down, immediately press the  button on the SmartKey twice in quick succession.  
The SmartKey's indicator light will light up once briefly and once for a long time.

#### Deactivating SmartKey function



- ▶ Press any button on the SmartKey.

- ❗ The SmartKey function will automatically be activated when the vehicle is started with the SmartKey in the gearshift console slot (→ page 97).

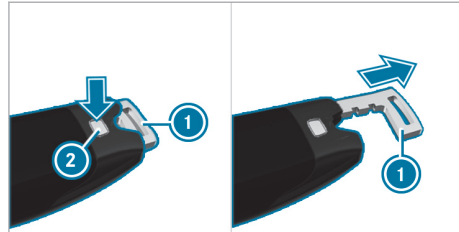

### Removing and inserting the mechanical key

#### Removing



- ▶ Press release button .
- ▶ Emergency key  is pushed slightly out.
- ▶ Pull mechanical key  out completely.

#### Inserting

- ▶ Press release button .
- ▶ Slide the mechanical key  in completely until it engages.

### Replacing the key battery

**⚠ DANGER** Risk of fatal injury due to swallowing batteries

Batteries contain toxic and corrosive substances. If batteries are swallowed or otherwise enter the body, severe internal burns can occur within two hours.

There is a risk of fatal injury!

- ▶ Keep the batteries out of the reach of children.
- ▶ If the lid and/or the battery compartment do not close securely, stop using the key and keep it away from children.
- ▶ If batteries are swallowed or otherwise enter the body, seek immediate medical attention.



**ENVIRONMENTAL NOTE** Environmental damage due to improper disposal of batteries



Batteries contain pollutants. It is illegal to dispose of them with the household rubbish.



Dispose of batteries in an environmentally responsible manner. Take discharged batteries to a qualified specialist workshop or to a collection point for used batteries.

#### Requirements:

- One CR 2032 3 V cell battery

Mercedes-Benz recommends that you have the battery replaced by a qualified specialist workshop.

- ▶ Removing the emergency key (→ page 40).



Example image

- ▶ Press release button ② down fully and slide cover ① forward.
- ▶ Remove battery compartment ③ and remove the discharged battery.
- ▶ Insert the new battery into battery compartment ③. Observe the positive pole marking in the battery compartment and on the battery.
- ▶ Insert battery compartment ③.
- ▶ Replace cover ① so that it engages.
- ▶ Slide the emergency key in completely until it engages (→ page 40).

#### Rectifying problems with the key

##### You can no longer lock or unlock the vehicle

Possible causes:

- The key battery is weak or discharged.
- There is interference from a powerful radio signal source.
- The key is faulty.

- ▶ Check the battery with the indicator lamp and replace if necessary (→ page 40).
- ▶ Use the mechanical key to unlock and lock the vehicle (→ page 40).
- ▶ Have the key checked at a qualified specialist workshop.

##### You have lost a key

- ▶ Have the key deactivated at a qualified specialist workshop.
- ▶ If necessary, have the mechanical locks replaced.

#### Doors

##### Unlocking and opening the door from inside

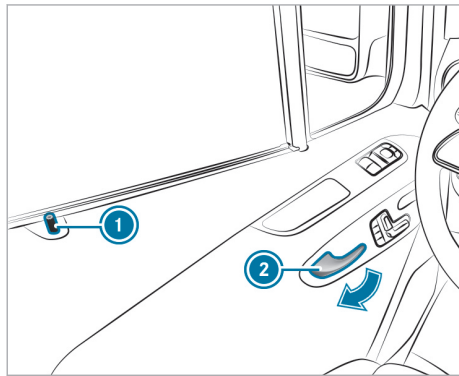

- ▶ **To unlock and open the front door:** pull door handle ②. Safety pin ① pops up when the door is unlocked.

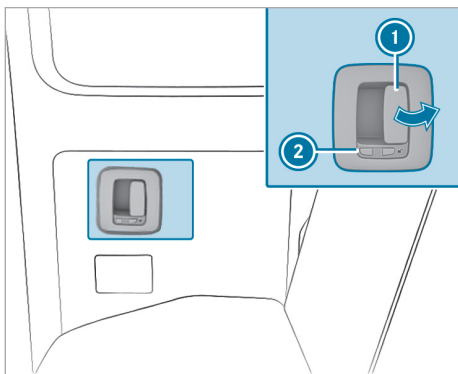

The  symbol indicates that the rear door is unlocked.

- ▶ **To unlock and open the rear door:** pull opening lever ① and open the rear door. When the door unlocks, latch ② moves forward.

The  symbol is visible.

- ▶ **To close:** pull the rear door closed by the door handle.

- ▶ **To lock:** slide latch ② back. The  symbol is visible.

### Centrally locking and unlocking the door from the inside

- ▲ **WARNING** Risk of accident and injury if children are left unattended in the vehicle

If children are left unattended in the vehicle, they could in particular:

- open doors, thereby endangering other persons or road users.
- get out and be struck by oncoming traffic.
- operate vehicle equipment and become trapped, for example.

In addition, the children could also set the vehicle in motion, for example by:

- releasing the parking brake.
- changing gear.
- starting the vehicle.

- ▶ Never leave children unattended in the vehicle.
- ▶ When leaving the vehicle, always take the SmartKey with you and lock the vehicle.

- ▶ Keep the SmartKey out of the reach of children.

- ▲ **WARNING** Risk of fatal injury due to exposure to extreme heat or cold in the vehicle

If persons, particularly children, are subjected to prolonged exposure to intense heat or cold, there is a risk of severe injury or even death.

- ▶ Never leave persons, particularly children, unattended in the vehicle.

You can use the central locking buttons to centrally lock and unlock the entire vehicle from the inside.

The central locking buttons are located in the driver's and front passenger door.

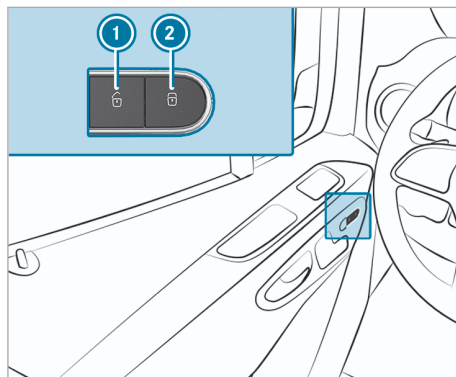

Central locking buttons (vehicles with electrically adjustable front seats)

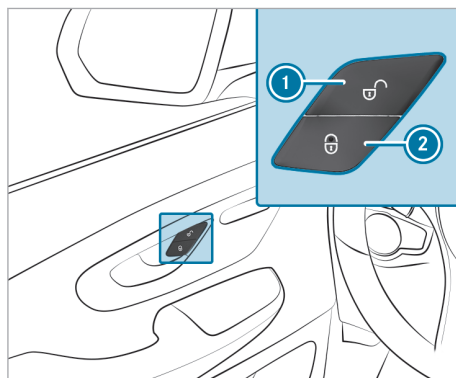

Central locking buttons (vehicles with manually adjustable front seats)

- ▶ **To unlock:** with the doors closed, press button ①.
- ▶ **To lock:** with the doors closed, press button ②.

### Activating/deactivating the automatic locking mechanism

#### Requirements:

- The power supply of the vehicle has been switched on.
- The doors are closed.

When the automatic locking mechanism is activated and the vehicle is traveling at a speed above 9 mph (15 km/h), the vehicle is locked automatically.

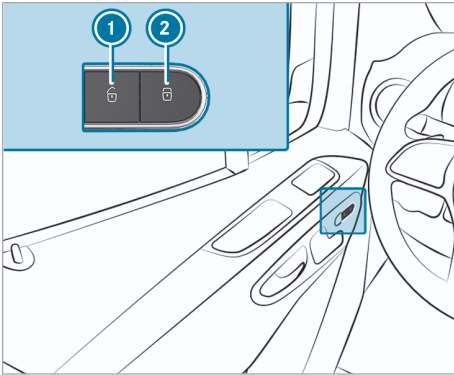

Central locking buttons (vehicles with electrically adjustable front seats)

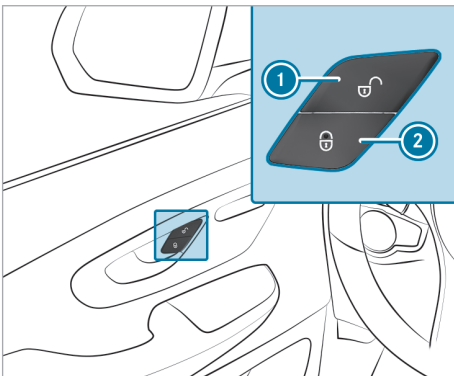

Central locking buttons (vehicles with manually adjustable front seats)

If the vehicle is being tow-started, push-started or tested on a roller dynamometer, there is a risk of being locked out when the function is activated.

- ▶ **To activate:** press and hold button ② until you hear a tone.
- ▶ **To deactivate:** press and hold button ① until you hear a tone.

### Activating or deactivating the automatic locking function via the multimedia system

Multimedia system:

▶ Home ▶ Settings ▶ Vehicle  
▶ Open/Close

① The vehicle is locked automatically when the vehicle is switched on and the wheels are turning faster than walking pace.

- ▶ Activate or deactivate **Automatic Door Lock**.

In the following situations there is a risk of being locked out when the function is activated:

- The vehicle is being towed or pushed.
- If the vehicle is being tested on a roller dynamometer.

### Automatic locking after closing the last door

**⚠ WARNING** Risk of fatal injury due to exposure to extreme heat or cold in the vehicle

If persons, particularly children, are subjected to prolonged exposure to intense heat or cold, there is a risk of severe injury or even death.

- ▶ Never leave persons, particularly children, unattended in the vehicle.

**⚠ WARNING** Risk of accident and injury if children are left unattended in the vehicle

If children are left unattended in the vehicle, they could in particular:

- open doors, thereby endangering other persons or road users.
- get out and be struck by oncoming traffic.
- operate vehicle equipment and become trapped, for example.

In addition, the children could also set the vehicle in motion, for example by:

- releasing the parking brake.
- changing gear.
- starting the vehicle.

- ▶ Never leave children unattended in the vehicle.
- ▶ When leaving the vehicle, always take the SmartKey with you and lock the vehicle.
- ▶ Keep the SmartKey out of the reach of children.

**⚠ WARNING** Accident- and risk of injury with unsecured or unattended animals in parked vehicle

If you leave animals in the vehicle unattended or unsecured, they could possibly press buttons or switches.

An animal may:

- Activate vehicle equipment and become trapped, for example.
- Switch systems on or off and endanger other road users

- ▶ Never leave animals in the vehicle unattended.
- ▶ Always secure animals properly, e.g. with a suitable animal transport box.

After leaving the vehicle and closing the last door, the vehicle is automatically locked. This also applies if the SmartKey is still in the vehicle.

There is a danger of locking oneself out. The vehicle can only be opened again with a SmartKey for the vehicle.

- Always carry the SmartKey for the vehicle with you when leaving the vehicle.
- i** If the vehicle is locked and the only available SmartKey is in the vehicle, notify a qualified specialist workshop.



Warning notice, depending on the equipment on the driver's door, the partition wall, the sliding door or the Speed Delivery Door

### Unlocking and locking the driver's door with the mechanical key

- i** If you want to lock the vehicle completely with the mechanical key, press the button for the locking mechanism from inside first with the driver's door open. Then lock the driver's door with the mechanical key.

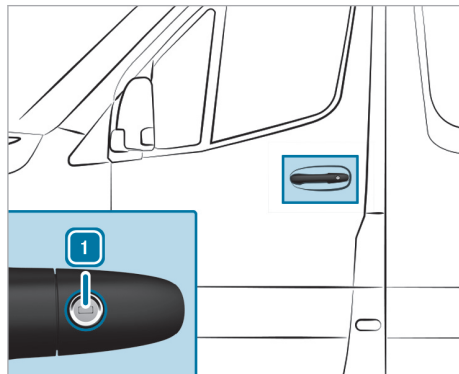

▶ **To unlock:** turn the mechanical key counter-clockwise to position **1**.

▶ **To lock:** turn the mechanical key clockwise to position **1**.

- i** **Right-hand drive vehicles:** turn the mechanical key in the opposite direction for each case.

### Using the grab handles when getting into and out of the vehicle

The entrances may be equipped with grab handles and steps. The grab handles to enter and exit the vehicle are at the front door and the sliding door.



**i** To avoid risks:

- When getting into and out of the vehicle, always use the grab handles and steps. These are specifically designed to withstand such loads.
- Keep steps and entrances free from dirt, e.g. mud, clay, snow and ice.

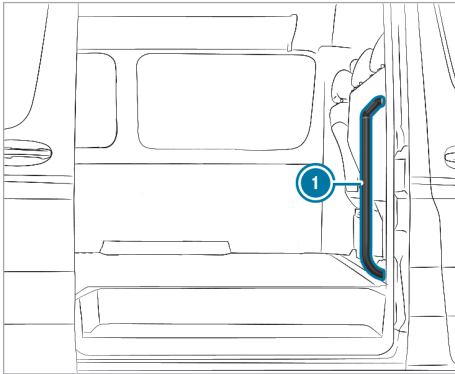

▶ When getting into and out of the vehicle, use the grab handles **1** and steps.

**i** The grab handles on the sliding door are provided as an easy entry and exit feature and can hold up to a maximum of 176 lbs (80 kg). Do not use the grab handle on the sliding door to secure a load (lashing). Do not secure any objects to the easy entry and exit features.

### Sliding door

#### Opening and closing the sliding door

**⚠ WARNING** Risk of becoming trapped due to an open sliding door which is not engaged in place

On an incline, the sliding door can move by itself.

This can cause you or other people to become trapped.

▶ Always make sure that the open sliding door is engaged. To do so, open the sliding door to the stop.

**⚠ WARNING** Risk of becoming trapped due to sliding door opening towards the rear

When you open the sliding door, the sliding door could hit other people as it moves towards the rear of the vehicle.

▶ Only open the sliding door when traffic conditions permit.

#### To unlock

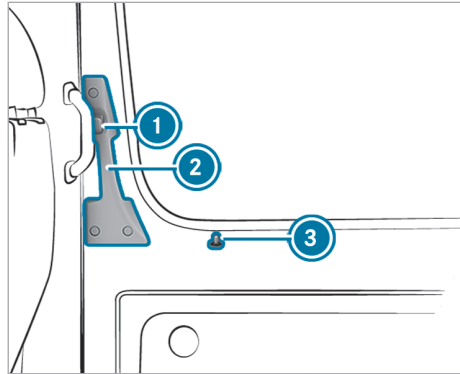

▶ Pull safety pin **3** upwards manually or use the central locking button to unlock the sliding door (→ page 42).

#### Opening

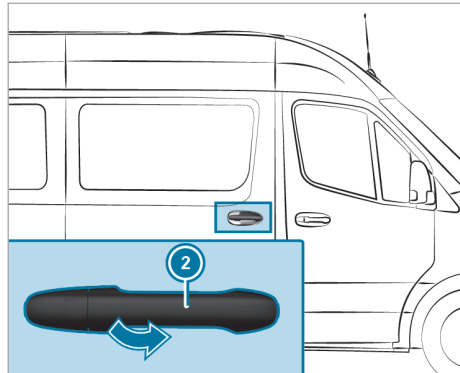

**i** Your vehicle may be equipped with a long sliding door with an intermediate catch. You can also lock the sliding door in place around half-way when opening and closing. This means you do not always have to open the door fully when getting in or out. The sliding door is not fully engaged when in the intermediate catch position.

▶ Press in the button **1** and pull the door **2** handle.

▶ Push back the sliding door fully using the door handle **2** until it engages.

▶ Check the sliding door catch.

**Closing**

- ▶ Press in the button ① and pull the door ② handle.
- ▶ Slide the sliding door firmly forwards using the door handle ② until it closes.

**To lock**

- ▶ Push safety pin ③ downwards manually or use the central locking button to lock the sliding door (→ page 42).

**Notes on electrical closing assist**

If your vehicle is fitted with electrical closing assist, you will require less force to close the sliding door.

**Electric sliding door****Function of the electric sliding door**

Your vehicle may be equipped with an electric sliding door on the left and/or right-hand side.

You can operate the electric sliding door in the following ways:

- by pressing the sliding door buttons on the center console
- by pressing the sliding door button on the door sill (B-pillar)
- using the door handle (inside or outside)
- using the key

If the electric sliding door is obstructed while opening, it will move a few centimeters in the opposite direction and then stop.

If the sliding door is obstructed during the closing procedure, it will open fully again.

If the electric motor of the sliding door is in danger of overheating, e.g. due to frequent opening and closing within a short period, the sliding door will open fully. The sliding door will then be locked in place. The sliding door will be operational again after approximately 30 seconds.

If there has been a malfunction or the battery has been disconnected, you can use the release catch to disconnect the sliding door from the electric motor. You will then be able to open or close the door manually (→ page 48).

**Opening/closing the electric sliding door with the button**

**⚠ WARNING** Risk of becoming trapped due to sliding door opening towards the rear

When you open the sliding door, the sliding door could hit other people as it moves towards the rear of the vehicle.

- ▶ Only open the sliding door when traffic conditions permit.

**⚠ WARNING** Risk of injury despite the object detection function

The object detection function does not react to soft, light and thin objects, such as fingers. The object detection function cannot prevent someone from becoming trapped in these situations.

- ▶ When opening and closing the electric sliding door, make sure that no parts of the body are within the operating range of the sliding door.
- ▶ If someone becomes trapped, press the button again to stop the sliding door.

**Object detection:**

If an object obstructs the sliding door as it closes, the sliding door will be stopped. Object detection is only an aid. It is not a substitute for your attentiveness.

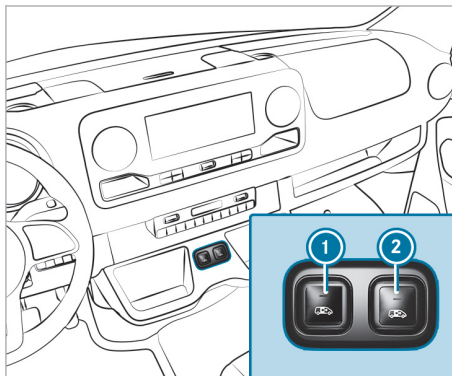

- ① Opens and closes the sliding door on the left side of the vehicle
- ② Opens and closes the sliding door on the right side of the vehicle

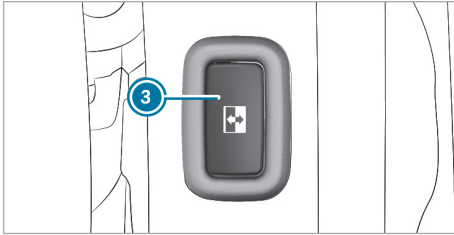

In vehicles with a partition, button 3 is located on the partition next to the door entrance at the height of the inside door handle.

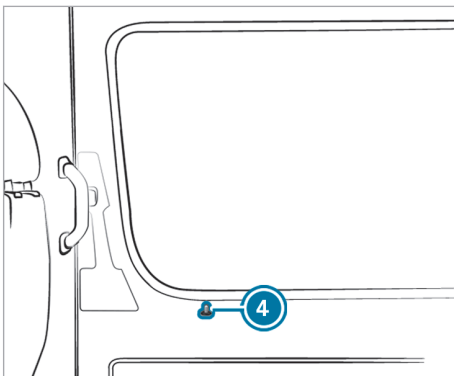









- ▶ **To unlock:** pull locking pin 4 up manually or use the central locking button to unlock the sliding door (→ page 42).
- ▶ **To open:** briefly press button 1, 2 or 3. The sliding door will open automatically. When you open the door using button 1 or 2, you will hear two acoustic signals. The indicator lamp at the top of button 1 or 2 will flash, and button 3 will flash. When the sliding door is completely open, the indicator lamp at the top of button 1 or 2 will light up.
- ▶ **To close:** briefly press button 1, 2 or 3. The sliding door will close automatically. When you close the door using button 1 or 2, you will also hear two acoustic signals. The indicator lamp at the top of button 1 or 2 will flash, and button 3 will flash. When the sliding door is completely closed, the indicator lamp at the top of button 1 or 2 will go out.

- ▶ **To stop automatic operation:** briefly press button 1 or 2. The sliding door will stop moving.

- ▶ **To lock:** push the locking pin 3 down manually or use the central locking button to lock the sliding door (→ page 42).

- ⓘ When you stop automatic operation during opening, the door will close when you press the button again.
- ⓘ In unfavorable operating conditions, e.g. frost or ice, or if the vehicle is very dirty, you can press and hold the corresponding button. The electric sliding door will then move with increased force. Note that, in such circumstances, the object detection function is less sensitive. To stop the movement, release the button.

#### Opening/closing the electric sliding door with the key

- ▶ **To unlock:** briefly press the  or  button on the key.
- ▶ **To open:** press and hold the  or  button on the key for longer than 0.5 seconds. You will hear two acoustic signals and the sliding door will open automatically.
- ▶ **To close:** press and hold the  or  button on the key for longer than 0.5 seconds. You will hear two acoustic signals and the sliding door will close automatically.
- ▶ **To interrupt automatic operation:** briefly press the  or  button on the key. The sliding door stops moving.
- ⓘ When you stop automatic operation upon opening the door, the door closes when you press the button again.

### Opening/closing the electric sliding door with the door handle

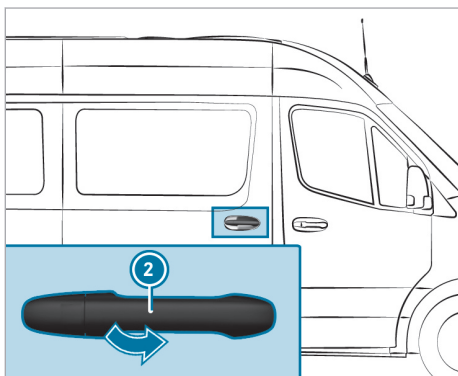
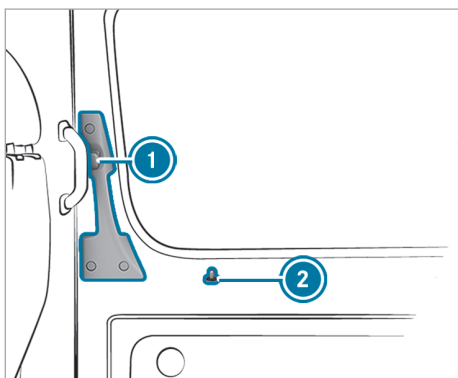

- ▶ Press button ① or pull outside door handle ②.  
The sliding door will open or close.
- ▶ Press button ① again or pull outside door handle ②.  
The sliding door will stop moving.

### Unlocking the electric sliding door manually

#### Disconnecting the sliding door from the electric motor

- ▶ Insert the emergency key into opening ① of disconnect switch ② in the "AUTO" position.
- ▶ Turn the emergency key 180° clockwise.  
The "MAN" position will be set.
- ▶ Open or close the sliding door with the outside or inside door handle.

#### Establishing the connection between the sliding door and electric motor

- ▶ Insert the emergency key into opening ① of disconnect switch ② in the "MAN" position.
- ▶ Turn the emergency key 180° counter-clockwise.  
The "AUTO" position will be set.
- ▶ Adjust the sliding door (→ page 48).

#### Unlocking

- ▶ Pull locking pin ③ up manually or use the central locking button to unlock the sliding door (→ page 42).
- ▶ Press release button ①.
- ▶ Open or close the sliding door with the outside or inside door handle.

#### Establishing the connection between the sliding door and electric motor

- ▶ Turn disconnect switch ② 180° counter-clockwise.  
The "AUTO" position will be set.
- ▶ Adjust the sliding door (→ page 48).
- ▶ If it is not possible to rectify the malfunction, visit a qualified specialist workshop.

### Resetting the electric sliding door

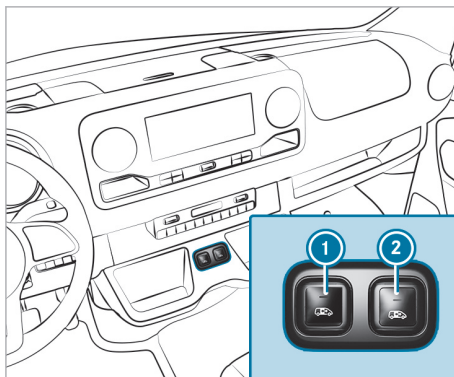

Sliding door buttons on the center console

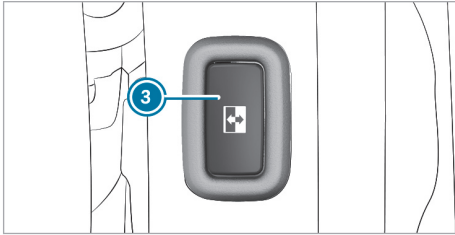

Sliding door button on the door frame (B-pillar)

You must reset the sliding door if there has been a malfunction or a voltage supply interruption.

- ▶ If the sliding door is open: press button ① or ② on the center console or sliding door button ③ on the door frame (B-pillar) and hold it until the door is closed.

or

- ▶ Close the sliding door with the door handle (→ page 48).
- ▶ Then briefly press button ① or ② on the center console or sliding door button ③ on the door frame (B-pillar) once, or pull the door handle (→ page 48) to open the sliding door completely. The sliding door will be operational.

### Rear-end doors

#### Opening and closing the rear-end doors from outside

- ⚠ **WARNING** Risk of injury due to the rear-end door swinging open

When you open a rear-end door, the following can occur:

- You or another person can be injured.
- A person may be struck by oncoming traffic.

This is particularly the case if you open the rear-end door more than 90° or if it opens in an uncontrolled manner.

Even rear-end doors which are properly closed can swing open when the vehicle parked is on an incline or it is windy.

- ▶ Only open a rear-end door when the traffic conditions and surroundings permit.
- ▶ Always make sure that the rear-end doors are properly closed.

- ⚠ **NOTE** Damage to the rear-end doors due to objects obstructing their range of movement

When the rear-end doors are opened, any objects obstructing the range of movement of the rear-end doors can be damaged as well as the vehicle.

- ▶ Make sure that there is sufficient clearance when opening the rear-end doors.

#### Opening the right rear-end door

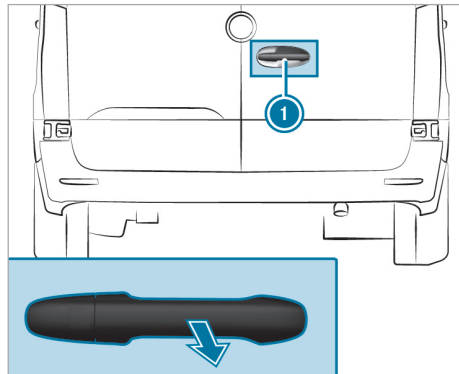

- ▶ Pull handle ①.
- ▶ Swing the rear-end door out to the side until it engages.

#### Opening the left rear-end door

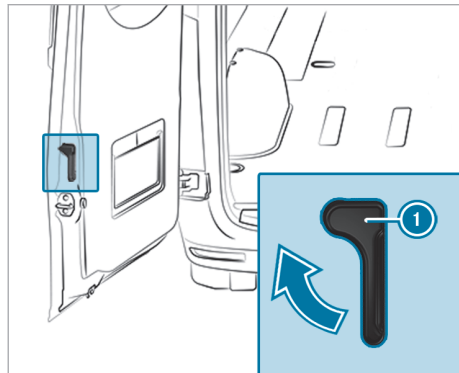

- ▶ Ensure that the right rear-end door is open and engaged.
- ▶ Pull release handle ① in the direction of the arrow.

- ▶ Swing the rear-end door out to the side until it engages.

#### Opening the rear-end doors fully

- ▶ Open the respective rear-end door beyond the first detent (90°).
- ▶ Open the rear-end door fully. The rear-end door will be retained in the stop position.

#### Closing the rear-end doors from outside

- ▶ Close the left rear-end door firmly from outside.
- ▶ Close the right rear-end door firmly from outside.

#### Opening rear-end doors with door retainer more than 90°

**⚠ WARNING** Risk of injury due to the rear-end door swinging open

When you open a rear-end door, the following can occur:

- You or another person can be injured.
- A person may be struck by oncoming traffic.

This is particularly the case if you open the rear-end door more than 90° or if it opens in an uncontrolled manner.

Even rear-end doors which are properly closed can swing open when the vehicle parked is on an incline or it is windy.

- ▶ Only open a rear-end door when the traffic conditions and surroundings permit.
- ▶ Always make sure that the rear-end doors are properly closed.

**! NOTE** Damage to the rear-end doors due to objects obstructing their range of movement

When the rear-end doors are opened, any objects obstructing the range of movement of the rear-end doors can be damaged as well as the vehicle.

- ▶ Make sure that there is sufficient clearance when opening the rear-end doors.

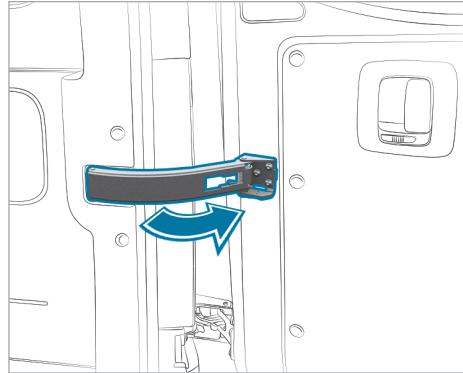

- ▶ Open the rear-end door approximately 45°.
- ▶ Pull and hold the door retainer in the direction of the arrow.
- ▶ Open the rear-end door at an angle greater than 90° so that the door retainer is no longer locked in place.
- ▶ Release the door check and open the tailgate to the steering limit.

#### Opening/closing the rear-end doors from the inside

**⚠ WARNING** Risk of injury due to the rear-end door swinging open

When you open a rear-end door, the following can occur:

- You or another person can be injured.
- A person may be struck by oncoming traffic.

This is particularly the case if you open the rear-end door more than 90° or if it opens in an uncontrolled manner.

Even rear-end doors which are properly closed can swing open when the vehicle parked is on an incline or it is windy.

- ▶ Only open a rear-end door when the traffic conditions and surroundings permit.
- ▶ Always make sure that the rear-end doors are properly closed.



**1 NOTE** Damage to the rear-end doors due to objects obstructing their range of movement

When the rear-end doors are opened, any objects obstructing the range of movement of the rear-end doors can be damaged as well as the vehicle.

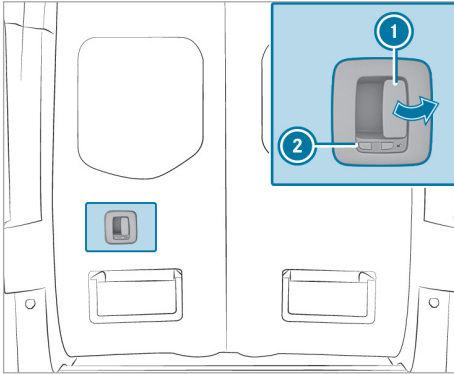
▶ Make sure that there is sufficient clearance when opening the rear-end doors.



The  symbol indicates that the rear-end door is unlocked.

- ▶ **To unlock:** slide latch 2 to the left. The  symbol is visible.
- ▶ **To open:** pull opening lever 1 and open the rear-end door. Swing the rear-end door to the side until it engages.
- ▶ **To close:** make sure that the left rear-end door is closed. Pull the rear right door firmly to by the door handle.
- ▶ **To lock:** slide latch 2 to the right. The  symbol is visible.

### Partition sliding door

#### Opening and closing the partition sliding door

**⚠ WARNING** Risk of becoming trapped if the partition sliding door is not engaged

The partition sliding door may move on its own while the vehicle is in motion.

This can cause you or other people to become trapped.

▶ Before every journey, close the partition sliding door and ensure that it is engaged.

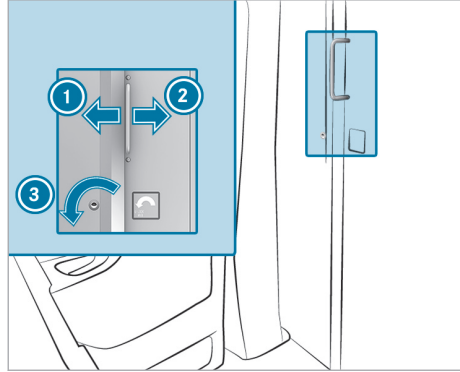

Partition from the cab

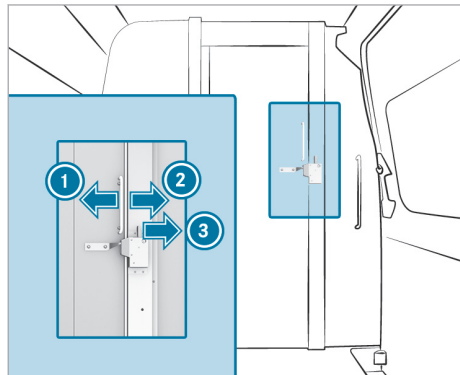

Partition from the cargo compartment

- ▶ **To open:** turn the key to the left 3 from the cab or push the lever to the right 3 from the cargo compartment. The sliding door will be unlocked.
- ▶ Push the sliding door as far as it will go to the right 2 from the cab or to the left 1 from the cargo compartment.
- ▶ **To close:** push the sliding door to the left 1 from the cab or to the right 2 from the cargo compartment until it engages. You can lock the sliding door from the cab with the key.

## Side window

### Opening and closing the side windows

- ⚠ WARNING** Risk of entrapment when opening a side window

When opening a side window, parts of the body could be drawn in or become trapped between the side window and window frame.

- ▶ When opening, make sure that nobody is touching the side window.
- ▶ If someone is trapped, release the button immediately or pull it in order to close the side window again.

- ⚠ WARNING** Risk of becoming trapped when closing a side window

When closing a side window, body parts could be trapped in the closing area in the process.

- ▶ When closing, make sure that no body parts are in the closing area.
- ▶ If someone is trapped, release the button immediately or press the button in order to reopen the side window.

- ⚠ WARNING** Risk of becoming trapped when children operate the side windows

Children could become trapped if they operate the side windows, particularly when unattended.

- ▶ Activate the child safety lock for the rear passenger compartment side windows.
- ▶ When leaving the vehicle, always take the SmartKey with you and lock the vehicle.
- ▶ Never leave children unattended in the vehicle.

- ⚠ WARNING** Risk of fatal injury due to exposure to extreme heat or cold in the vehicle

If persons, particularly children, are subjected to prolonged exposure to intense heat or cold, there is a risk of severe injury or even death.

- ▶ Never leave persons, particularly children, unattended in the vehicle.

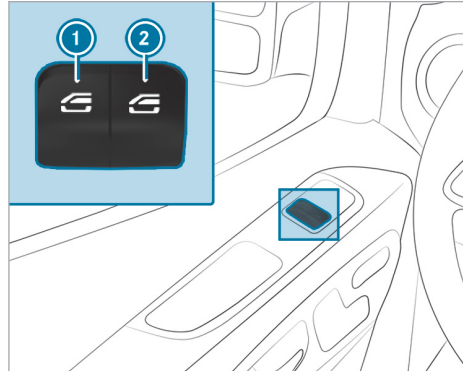

- ▶ **To open manually:** press and hold button ① or ②.
- ▶ **To close manually:** pull and hold button ① or ②.

The windows in the front doors can also be operated automatically.

- ▶ **To open completely:** briefly press button ① or ② beyond the pressure point. Automatic operation will start.
- ▶ **To close completely:** briefly pull button ① or ② beyond the pressure point. Automatic operation will start.
- ▶ **To interrupt automatic operation:** briefly press or pull button ① or ② again.

- ① If an object blocks a side window during the automatic closing process, the side window will open again automatically. The automatic reversing function is only an aid and is not a substitute for your attentiveness.
- ① If automatic operation of the side window does not work, there will also be no automatic reversing function.

#### Automatic reversing function of the side windows

If an object blocks a side window during the closing process, the side window will open again automatically. The automatic reversing function is only an aid and is not a substitute for your attentiveness.

- ▶ During the closing process, make sure that no body parts are in the closing area.



**▲ WARNING** Risk of becoming trapped despite there being reversing protection on the side window

The reversing function will not react:

- to soft, light and thin objects, e.g. fingers
- over the last 1/6 in (4 mm) of the closing path
- during resetting
- when the side window is closed again manually immediately after automatic reversing

The reversing function cannot prevent someone from becoming trapped in these situations.

- ▶ During the closing process, make sure that no body parts are in the closing area.
- ▶ If someone becomes trapped, press the  button to open the side window again.

### Adjusting the side windows

The side windows must be readjusted after a malfunction or a voltage supply interruption.

- ▶ Switch on the power supply (→ page 96).
- ▶ Push both buttons on the power window and hold for approximately one second after the side window has closed.

### Rectifying problems with the side windows

**A side window cannot be closed and you cannot see the cause**

- ▶ Check to see if there are any objects in the window guide.

**▲ WARNING** Risk of becoming trapped or fatally injured if reversing protection is not activated

If you close a side window again immediately after it has been blocked, the side window will close with increased or maximum force. The reversing function is then not active and body parts may become trapped.

- ▶ Make sure that no parts of the body are in the closing area.

- ▶ To stop the closing process, release the button or press the button again to reopen the side window.

If a side window is obstructed during closing and reopens again slightly, you can proceed as follows:

- ▶ Immediately after the window is obstructed, pull the corresponding button again until the side window has closed. Then pull and hold the button for another second. The side window will be closed with increased force.

If the side window is obstructed again and reopens slightly, you can proceed as follows:

- ▶ Repeat the previous step. The side window will be closed without the automatic reversing function.
- ▶ If a side window is obstructed again during closing and reopens again slightly, consult a qualified specialist workshop.

### Anti-theft prevention

#### Function of immobilizer

The immobilizer prevents your vehicle from being started without the correct key.

The immobilizer is automatically activated when the vehicle is switched off, and deactivated when the vehicle is switched on.

When leaving the vehicle, always take the key with you and lock the vehicle. If the key is left inside the vehicle, anyone can start the vehicle.

- ⓘ In the event the engine does not start despite the vehicle's starter battery having sufficient charge, the immobilizer is faulty. Contact a qualified specialist workshop or call 1-800-367-6372 (in the USA) or 1-800-387-0100 (in Canada).

### ATA (Anti-Theft Alarm system)

#### Function of ATA (Anti-Theft Alarm system)

If the ATA system is armed, a visual and audible alarm is triggered in the following situations:

- a side door is opened
- the rear-end door is opened
- the hood is opened

- the interior protection is triggered (→ page 55)
- the tow-away alarm is triggered (→ page 54)

The alarm will not be deactivated, even if the door which was opened to trigger the alarm is immediately closed again, for example.

Canceling a triggered alarm (→ page 54).

The ATA is activated automatically after approximately ten seconds in the following instance:

- after the vehicle has been locked with the key

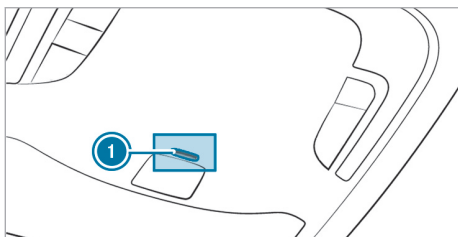

When the ATA system is armed, an indicator lamp ① flashes in the overhead control panel.

ATA is automatically deactivated in the following situations:

- after unlocking the vehicle with the key
- after pressing the start/stop button with the key inside the vehicle.

### Arms/deactivates ATA (anti-theft alarm system)

#### Arming

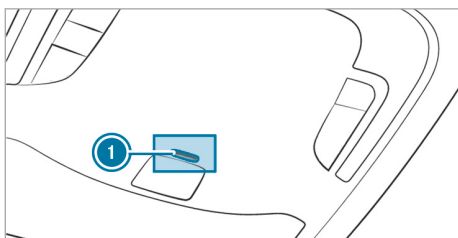



- ▶ Close all the doors.
- ① Close the side window or deactivate the interior protection (→ page 55) to prevent a false alarm.
- ▶ Lock the vehicle with the key. Indicator lamp ① in the overhead control panel flashes.

#### Deactivating

- ▶ Unlock the vehicle with the key. Indicator lamp ① in the overhead control panel goes out.

- ① The vehicle locks again automatically if you do not open a door within 40 seconds after unlocking the vehicle.

#### Stopping the alarm

- ▶ Press the  or  button on the key.

or

- ▶ Press the Start/Stop button with the key inside the vehicle. The alarm stops.

#### Function of the tow-away alarm

When the tow-away alarm is armed, a visual and audible alarm is triggered if the vehicle's inclination changes. This may be the case, for example, if the vehicle is lifted on one side.

#### Arming or deactivating the tow-away alarm

##### Arming/deactivating

- ▶ Lock the vehicle with the key. The tow-away alarm is automatically armed after about 40 seconds.
- ▶ Open the vehicle with the key. The tow-away alarm is deactivated.

The tow-away alarm is activated if the following condition is met:

- All the doors are closed.

#### Deactivating

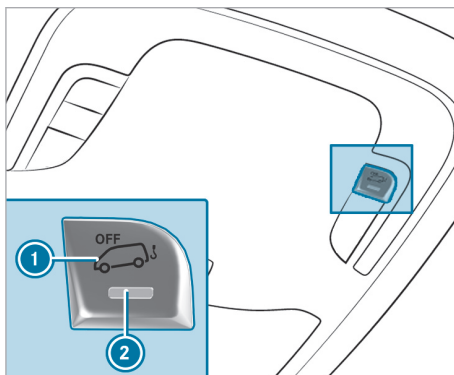

- ▶ Switch off the vehicle (→ page 96).

- ▶ Press the ① button.  
When the button is released, the indicator lamp ② in the button lights up for approximately three seconds.
- ▶ Lock the vehicle with the key.  
The tow-away alarm is deactivated.

The tow-away alarm is activated again in the following instances:

- the vehicle is unlocked again.
- a door is opened
- the vehicle is locked again.

Deactivate the tow-away alarm when locking your vehicle in the following situations:

- when loading and/or transporting the vehicle on a ferry or car transporter, for example
- when parking the vehicle on a movable surface, such as a split-level garage

False alarms will thus be prevented.

### Interior protection

#### Function

A visual and acoustic alarm is triggered if the armed interior protection detects motion in the vehicle interior.

### Arming/deactivating the interior protection

#### Arming

- ▶ Close the side windows.
- ▶ Ensure that no objects (such as mascots or clothes hangers) are hanging on the inside mirror or on the grab handles. False alarms will thus be prevented.
- ▶ Lock the vehicle with the key.  
The interior protection is armed after approximately 40 seconds.

The interior protection is activated if the following condition is met:

- All the doors are closed.

#### Switching off

- ▶ Unlock the vehicle with the key.  
The interior protection automatically switches off.

### Deactivating

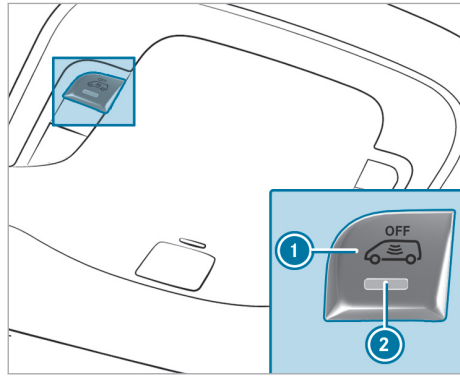

- ▶ Switch off the vehicle (→ page 96).
- ▶ Press the ① button.  
When the button is released, indicator lamp ② in the button lights up for approximately three seconds.
- ▶ Lock the vehicle with the key.  
The interior protection is deactivated.

The interior protection is activated again in the following instances:

- the vehicle is unlocked again.
- a door is opened
- the vehicle is locked again.

Deactivate the interior protection when locking your vehicle in the following situations:

- people or animals remain inside the vehicle
- if the side windows remain open
- when transporting the vehicle, for example on a ferry or car transporter.

False alarms will thus be prevented.

### Notes on the correct driver's seat position

**⚠ WARNING** Risk of accident due to adjusting the vehicle settings while the vehicle is in motion

You could lose control of the vehicle in the following situations in particular:

- If you adjust the driver's seat, the head restraint, the steering wheel or the mirror while the vehicle is in motion
- If you fasten your seat belt while the vehicle is in motion

▶ Before starting the vehicle: in particular, adjust the driver's seat, head restraint, steering wheel and mirror, and fasten your seat belt.

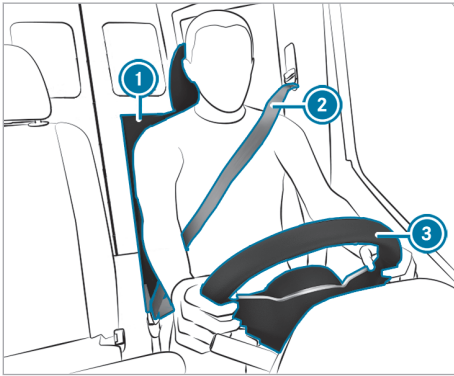

Ensure the following when adjusting steering wheel

③, seat belt ② or driver's seat ①:

- You are sitting as far away from the driver's air bag as possible.
- You are sitting in an upright position.
- Your thighs are gently supported by the seat cushion.
- Your legs are not fully extended and you can reach the pedals easily.
- The back of your head is supported at eye level by the middle part of the head restraint.
- You can hold the steering wheel with your arms slightly bent.
- You can move your legs without any restrictions.
- You can see all of the instrument cluster displays well.

- You have a good overview of the traffic conditions.
- Your seat belt sits snugly against your body and passes across the center of your shoulder and across your hips in the pelvic area.

### Notes on grab handles

**⚠ WARNING** Risk of injury due to excessive load on the grab handles

If you apply your full body weight to the grab handle or pull it abruptly, the grab handle may be damaged or come loose from its anchorage. This may result in injuries.

▶ Use the grab handles only to stabilize the seating position or to assist in getting in and out of the seat.

### Seats

#### Adjusting the front seats manually (without Seat Comfort Package)

**⚠ WARNING** Risk of becoming trapped if the seat is adjusted by children

Children could become trapped if they adjust the seats, particularly if they are unattended.

- ▶ When leaving the vehicle, always take the key with you and lock the vehicle.
- ▶ Never leave children unattended in the vehicle.

**⚠ WARNING** Risk of becoming trapped when adjusting the seat

When you adjust a seat, you or other vehicle occupants could become trapped, e.g. on the seat guide rail.

- ▶ When adjusting a seat, make sure that no one has any part of their body within the sweep of the seat.

Observe the safety notes on "Air bags" and "Children in the vehicle".

**⚠ WARNING** Risk of accident due to the driver's seat not being engaged

The driver's seat may move unexpectedly while driving.

This could cause you to lose control of the vehicle.

- ▶ Always make sure that the driver's seat is engaged before starting the vehicle.

**⚠ WARNING** Risk of accident due to adjusting the vehicle settings while the vehicle is in motion

You could lose control of the vehicle in the following situations in particular:

- If you adjust the driver's seat, the head restraint, the steering wheel or the mirror while the vehicle is in motion
  - If you fasten your seat belt while the vehicle is in motion
- ▶ Before starting the vehicle: in particular, adjust the driver's seat, head restraint, steering wheel and mirror, and fasten your seat belt.

**⚠ WARNING** Risk of becoming trapped if the seat height is adjusted carelessly

If you adjust the seat height carelessly, you or other vehicle occupants could be trapped and thereby injured.

Children in particular could accidentally press the electrical seat adjustment buttons and become trapped.

- ▶ While moving the seats, make sure that hands or other body parts do not get under the lever assembly of the seat adjustment system.

**⚠ WARNING** Risk of injury due to head restraints not being installed or being adjusted incorrectly

If head restraints have not been installed or have not been adjusted correctly, there is an increased risk of injury in the head and neck area, e.g. in the event of an accident or when braking.

- ▶ Always drive with the head restraints installed.
- ▶ Before driving off, make sure for every vehicle occupant that the center of the head restraint supports the back of the head at about eye level.

Using the head restraint fore-and-aft adjustment, adjust the head restraint so that it is as close to the back of your head as possible.

**⚠ WARNING** Risk of injury or death due to an incorrect seat position

The seat belt does not offer the intended level of protection if you have not moved the seat backrest to an almost vertical position.

In particular, you could slip beneath the seat-belt and become injured.

- ▶ Adjust the seat properly before beginning your journey.
- ▶ Always ensure that the seat backrest is in an almost vertical position and that the shoulder belt is routed across the center of your shoulder.

**! NOTE** Damage to the seats when moving the seats back

The seats may be damaged by objects when moving the seats back.

- ▶ When moving the seats back, make sure that there are no objects in the footwell, under or behind the seats.

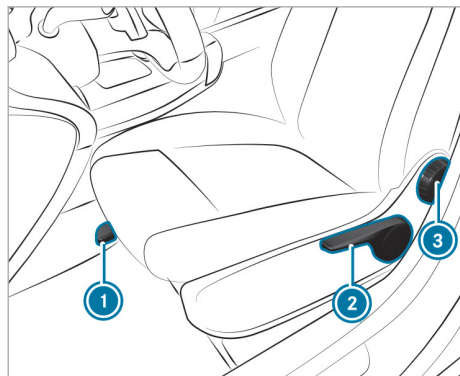

- ① Seat fore-and-aft position
- ② Seat height
- ③ Seat backrest inclination

▶ **To adjust the seat fore-and-aft position:** lift lever ① and slide the seat into the desired position. Ensure that the seat is engaged.

▶ **To adjust the seat height:** keep on pressing or pulling lever ② until the required seat height has been reached.

- ▶ **To adjust the seat backrest inclination:** rotate handwheel ③ forwards and backwards until the desired position has been reached.

### Adjusting the front seats manually (with Seat Comfort Package)

- ▲ **WARNING** Risk of becoming trapped if the seat is adjusted by children

Children could become trapped if they adjust the seats, particularly if they are unattended.

- ▶ When leaving the vehicle, always take the key with you and lock the vehicle.
- ▶ Never leave children unattended in the vehicle.

- ▲ **WARNING** Risk of becoming trapped when adjusting the seat

When you adjust a seat, you or other vehicle occupants could become trapped, e.g. on the seat guide rail.

- ▶ When adjusting a seat, make sure that no one has any part of their body within the sweep of the seat.

Observe the safety notes on "Air bags" and "Children in the vehicle".

- ▲ **WARNING** Risk of accident due to the driver's seat not being engaged

The driver's seat may move unexpectedly while driving.

This could cause you to lose control of the vehicle.

- ▶ Always make sure that the driver's seat is engaged before starting the vehicle.

- ▲ **WARNING** Risk of accident due to adjusting the vehicle settings while the vehicle is in motion

You could lose control of the vehicle in the following situations in particular:

- If you adjust the driver's seat, the head restraint, the steering wheel or the mirror while the vehicle is in motion
- If you fasten your seat belt while the vehicle is in motion
- ▶ Before starting the vehicle: in particular, adjust the driver's seat, head restraint,

steering wheel and mirror, and fasten your seat belt.

- ▲ **WARNING** Risk of becoming trapped if the seat height is adjusted carelessly

If you adjust the seat height carelessly, you or other vehicle occupants could be trapped and thereby injured.

Children in particular could accidentally press the electrical seat adjustment buttons and become trapped.

- ▶ While moving the seats, make sure that hands or other body parts do not get under the lever assembly of the seat adjustment system.

- ▲ **WARNING** Risk of injury due to head restraints not being installed or being adjusted incorrectly

If head restraints have not been installed or have not been adjusted correctly, there is an increased risk of injury in the head and neck area, e.g. in the event of an accident or when braking.

- ▶ Always drive with the head restraints installed.
- ▶ Before driving off, make sure for every vehicle occupant that the center of the head restraint supports the back of the head at about eye level.

Using the head restraint fore-and-aft adjustment, adjust the head restraint so that it is as close to the back of your head as possible.

- ▲ **WARNING** Risk of injury or death due to an incorrect seat position

The seat belt does not offer the intended level of protection if you have not moved the seat backrest to an almost vertical position.

In particular, you could slip beneath the seat-belt and become injured.

- ▶ Adjust the seat properly before beginning your journey.
- ▶ Always ensure that the seat backrest is in an almost vertical position and that the shoulder belt is routed across the center of your shoulder.

**1 NOTE** Damage to the seats when moving the seats back

The seats may be damaged by objects when moving the seats back.

- ▶ When moving the seats back, make sure that there are no objects in the footwell, under or behind the seats.

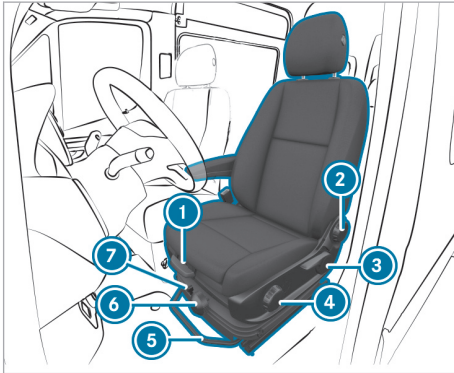

Example image of comfort suspension seat

- ① Seat cushion length
- ② Seat backrest inclination
- ③ Seat height
- ④ Seat cushion inclination
- ⑤ Seat fore-and-aft position
- ⑥ Seat suspension
- ⑦ Seat suspension lock

- ▶ **To adjust the seat cushion length:** lift lever ① and slide the front part of the seat cushion forwards or backwards.
- ▶ **To adjust the seat backrest inclination:** rotate handwheel ② forwards and backwards until the desired position has been reached.
- ▶ **To adjust the seat height:** pull or push lever ③ until the desired position has been reached.
- ▶ **To adjust the seat cushion inclination:** rotate handwheel ④ forwards and backwards until the desired position has been reached.
- ▶ **To adjust the seat fore-and-aft position:** lift lever ⑤ and slide the seat into the desired position.
- ▶ **To check for safety:** ensure that the seat is engaged.
- ▶ **To adjust the seat suspension:** take your weight off the seat.

- ▶ Using handwheel ⑥, set the body weight (88 lb (40 kg) to 265 lb (120 kg)) so that the seat suspension works optimally. If you set a higher weight, the seat suspension will become firmer. The seat will then not vibrate as much. If the seat vibrates often and significantly, you can engage it in the lower area.
- ▶ **To engage the seat suspension lock:** turn lever ⑦ upwards. The next time the seat vibrates, it will engage.
- ▶ **To release the seat suspension lock:** turn lever ⑦ to the right. The seat will then be able to vibrate.

### Adjusting the front seat electrically

**▲ WARNING** Risk of becoming trapped if the seat is adjusted by children

Children could become trapped if they adjust the seats, particularly if they are unattended.

- ▶ When leaving the vehicle, always take the key with you and lock the vehicle.
- ▶ Never leave children unattended in the vehicle.

The seats can be adjusted when the vehicle is switched off.

**▲ WARNING** Risk of becoming trapped when adjusting the seat

When you adjust a seat, you or other vehicle occupants could become trapped, e.g. on the seat guide rail.

- ▶ When adjusting a seat, make sure that no one has any part of their body within the sweep of the seat.

Observe the safety notes on "Air bags" and "Children in the vehicle".

**▲ WARNING** Risk of accident due to the driver's seat not being engaged

The driver's seat may move unexpectedly while driving.

This could cause you to lose control of the vehicle.

- ▶ Always make sure that the driver's seat is engaged before starting the vehicle.

**⚠ WARNING** Risk of accident due to adjusting the vehicle settings while the vehicle is in motion

You could lose control of the vehicle in the following situations in particular:

- If you adjust the driver's seat, the head restraint, the steering wheel or the mirror while the vehicle is in motion
  - If you fasten your seat belt while the vehicle is in motion
- ▶ Before starting the vehicle: in particular, adjust the driver's seat, head restraint, steering wheel and mirror, and fasten your seat belt.

**⚠ WARNING** Risk of becoming trapped if the seat height is adjusted carelessly

If you adjust the seat height carelessly, you or other vehicle occupants could be trapped and thereby injured.

Children in particular could accidentally press the electrical seat adjustment buttons and become trapped.

- ▶ While moving the seats, make sure that hands or other body parts do not get under the lever assembly of the seat adjustment system.

**⚠ WARNING** Risk of injury due to head restraints not being installed or being adjusted incorrectly

If head restraints have not been installed or have not been adjusted correctly, there is an increased risk of injury in the head and neck area, e.g. in the event of an accident or when braking.

- ▶ Always drive with the head restraints installed.
- ▶ Before driving off, make sure for every vehicle occupant that the center of the head restraint supports the back of the head at about eye level.

Do not interchange the head restraints of the front and rear seats. Otherwise, you will not be able to set the height and inclination of the head restraints to the correct position.

Using the head restraint fore-and-aft adjustment, adjust the head restraint so that it is as close to the back of your head as possible.

**⚠ WARNING** Risk of injury or death due to an incorrect seat position

The seat belt does not offer the intended level of protection if you have not moved the seat backrest to an almost vertical position.

In particular, you could slip beneath the seat-belt and become injured.

- ▶ Adjust the seat properly before beginning your journey.
- ▶ Always ensure that the seat backrest is in an almost vertical position and that the shoulder belt is routed across the center of your shoulder.

**! NOTE** Damage to the seats when moving the seats back

The seats may be damaged by objects when moving the seats back.

- ▶ When moving the seats back, make sure that there are no objects in the footwell, under or behind the seats.

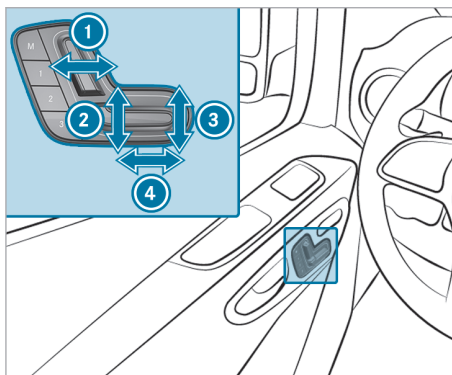

- ① Seat backrest inclination
- ② Seat height
- ③ Seat cushion inclination
- ④ Seat fore-and-aft position

- ▶ Save the settings with the memory function (→ page 61).



### Setting 4-way lumbar support

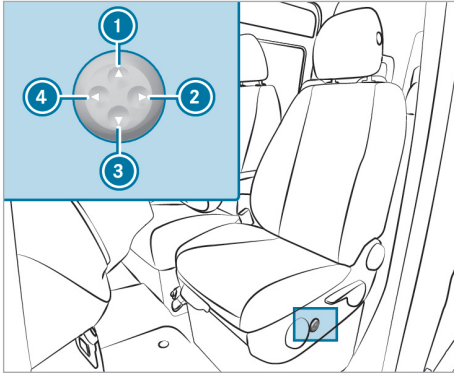

- ① Higher
- ② Softer
- ③ Lower
- ④ Firmer

▶ Use buttons ① to ④ adjust the backrest contour individually to your spine.

### Operating the memory function

**⚠ WARNING** Risk of an accident if the memory function is used while driving

If you use the memory function on the driver's side while driving, you could lose control of the vehicle as a result of the adjustments being made.

▶ Only use the memory function on the driver's side when the vehicle is stationary.

**⚠ WARNING** Risk of entrapment when adjusting the seat with the memory function

When the memory function adjusts the seat, you and other vehicle occupants – particularly children – could become trapped.

- ▶ During the adjustment process of the memory function, make sure that no one has any body parts in the sweep of the seat.
- ▶ If somebody becomes trapped, immediately release the memory function position button. The adjustment process is stopped.

**⚠ WARNING** Danger of entrapment when memory function is activated by children

When children activate the memory function, they can get trapped, especially if they are unsupervised.

- ▶ Never leave children unattended in the vehicle.
- ▶ When leaving the vehicle, always take the key with you and lock the vehicle.

The memory function can be used when the vehicle is switched off.

### Storing seat adjustments

Seat adjustments for up to three people can be stored and called up using the memory function. You can adjust the seat and the backrest.

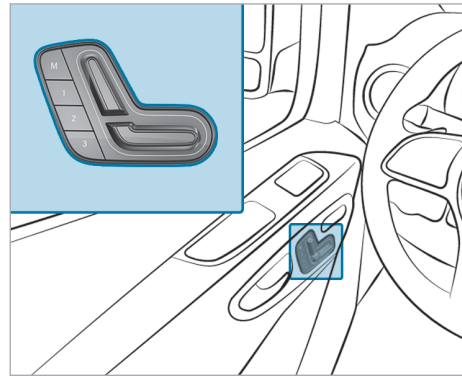

- ▶ Adjust the seat to the desired position.
- ▶ Press memory button M together with one of preset position buttons 1, 2 or 3. An acoustic signal will sound. The settings are stored.
- ▶ **To call up:** press and hold preset position button 1, 2 or 3 until the front seat is in the stored position.

### Rotating the front seats

**⚠ WARNING** Risk of injury or fatal injuries if the driver's seat and front passenger seat are not engaged

In this situation, the restraint systems cannot perform their intended protective function.

- ▶ Engage the driver's seat and front passenger seat in the direction of travel before you start the vehicle.

**⚠ WARNING** Risk of accident due to adjusting the vehicle settings while the vehicle is in motion

You could lose control of the vehicle in the following situations in particular:

- If you adjust the driver's seat, the head restraint, the steering wheel or the mirror while the vehicle is in motion
- If you fasten your seat belt while the vehicle is in motion

- ▶ Before starting the vehicle: in particular, adjust the driver's seat, head restraint, steering wheel and mirror, and fasten your seat belt.

**⚠ WARNING** Risk of injury when the seat is pushed backwards

If the seat has been pushed backwards, you may injure yourself on the seat guide rails protruding at the front.

- ▶ Make sure that you do not touch the seat guide rails.



You can rotate the driver's and front passenger seats by 50° and 180°. The seats engage both in and opposite to the direction of travel as well as at 50° towards the exit.

- ▶ Ensure that the parking brake is applied and the brake lever (if applicable) is down as far as it will go (→ page 117).

- ▶ When rotating the seat, open the respective front door in order to avoid a collision with the door trim.
- ▶ Adjust the steering wheel in such a way that there is sufficient clearance to rotate and adjust the driver's seat (→ page 64).
- ▶ Slide the front passenger seat forward before rotating it (→ page 56).
- ▶ **To rotate the seat:** push lever ① towards the door and rotate the seat slightly inwards. The turning device will be unlocked.
- ▶ Release lever ① again.
- ▶ Rotate the seat outwards or inwards into the required position.

### Folding the co-driver bench seat cushion forwards and backwards

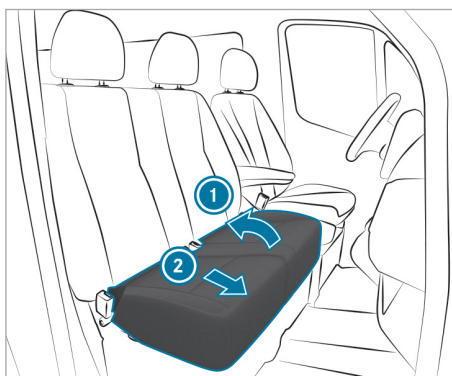

- ▶ **To fold the seat surface forward:** lift seat surface out of front anchorage ①.
- ▶ Pull the seat surface out of rear anchorage ② and move it slightly forwards.
- ▶ Fold the rear edge of the seat surface upwards.
- ▶ **To fold back the seat surface:** fold the rear edge of the seat surface downwards.
- ▶ Slide the seat surface under the seat backrest into rear anchorage ②.
- ▶ Push the front seat surface downwards until it engages in front anchorage ①.

**i** You can stow individual objects in the stowage compartment beneath the co-driver bench seat.

### Folding the folding seat up or down

**⚠ WARNING** Risk of injury when using the folding seat due to inserted key

The key in the lock of the partition wall sliding door may come into contact with the person on the folding seat.

- ▶ Always remove the key before a person sits on the folding seat.

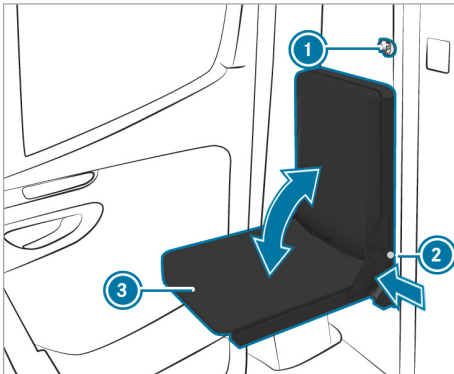

- ▶ Remove key ① from the partition sliding door.
- ▶ Press the push button on catch ② and fold seat cushion ③ up or down.
- ▶ Release push button on catch ② when seat cushion ③ reaches its end position.
- ▶ Move seat cushion ③ until it has locked. The push button on catch ② must be completely flush with the seat frame.

### Head restraints

#### Adjusting the head restraint manually

**⚠ WARNING** Risk of accident due to adjusting the vehicle settings while the vehicle is in motion

You could lose control of the vehicle in the following situations in particular:

- If you adjust the driver's seat, the head restraint, the steering wheel or the mirror while the vehicle is in motion
- If you fasten your seat belt while the vehicle is in motion

- ▶ Before starting the vehicle: in particular, adjust the driver's seat, head restraint,

steering wheel and mirror, and fasten your seat belt.

**⚠ WARNING** Risk of injury due to head restraints not being installed or being adjusted incorrectly

If head restraints have not been installed or have not been adjusted correctly, there is an increased risk of injury in the head and neck area, e.g. in the event of an accident or when braking.

- ▶ Always drive with the head restraints installed.
- ▶ Before driving off, make sure for every vehicle occupant that the center of the head restraint supports the back of the head at about eye level.

Using the head restraint fore-and-aft adjustment, adjust the head restraint so that it is as close to the back of your head as possible.

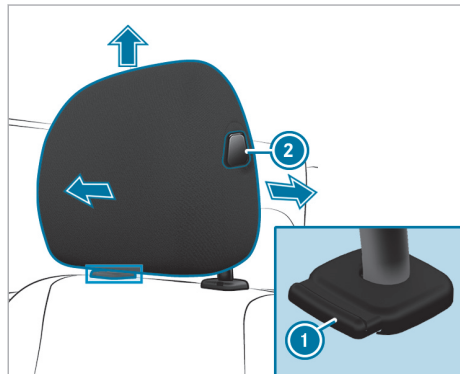

Head restraint (example of luxury head restraint on the driver's seat)

- ▶ **To raise:** pull the head restraint upwards into the desired position and ensure that it engages.

ⓘ Use the head restraint only when it is engaged.

- ▶ **To lower:** press release button ①, slide the head restraint downwards into the desired position and ensure that it engages.

ⓘ Use the head restraint only when it is engaged.

- ▶ **To move forwards:** press release button ② and pull the head restraint forwards until it engages in the desired position.
- ▶ **To move backwards:** press release button ② and slide the head restraint backwards into the desired position.
- ▶ **To remove:** press release button ① and pull the head restraint up and out.
- ▶ **To install:** press the head restraint with detent on the left-hand side when viewed in the direction of travel into the holes until it engages.

### Switching the seat heating on/off

**⚠ WARNING** Risk of burns due to repeatedly switching on the seat heating

Repeatedly switching on the seat heating can cause the seat cushion and seat backrest padding to become very hot.

In particular, the health of persons with limited temperature sensitivity or a limited ability to react to high temperatures may be affected or they may even suffer burn-like injuries.

- ▶ Do not repeatedly switch on the seat heating.

To protect against overheating, the seat heating may be temporarily deactivated after it is switched on repeatedly.

**! NOTE** Damage to the seats caused by objects or documents when the seat heating is switched on

When the seat heating is switched on, overheating may occur due to objects or documents placed on the seats, e.g. seat cushions or child seats. This could cause damage to the seat surface.

- ▶ Make sure that no objects or documents are on the seats when the seat heating is switched on.

### Requirements:

- The power supply is switched on.

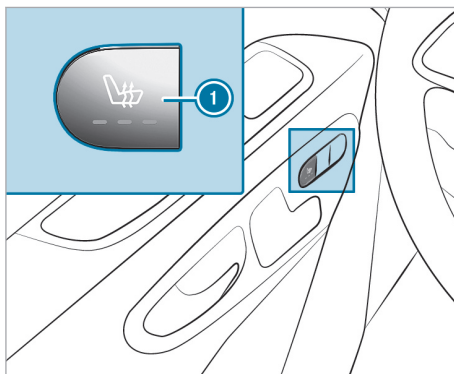

- ▶ **To switch on:** press the ① button. All indicator lamps on the button light up.
  - ▶ **To lower the level:** press button ① until the required heating level is reached. Depending on the heating level, one to three indicator lamps will light up.
  - ▶ **To switch off:** press button ① until all indicator lamps are off.
- ⓘ The seat heater automatically switches back out of the three heating levels after 8, 10 and 20 minutes until the seat heater switches off.

### Steering wheel

#### Adjusting the steering wheel

**⚠ WARNING** Risk of accident due to adjusting the vehicle settings while the vehicle is in motion

You could lose control of the vehicle in the following situations in particular:

- If you adjust the driver's seat, the head restraint, the steering wheel or the mirror while the vehicle is in motion
  - If you fasten your seat belt while the vehicle is in motion
- ▶ Before starting the vehicle: in particular, adjust the driver's seat, head restraint, steering wheel and mirror, and fasten your seat belt.

**⚠ WARNING** Risk of accident due to unlocked steering wheel

The steering wheel may move unexpectedly if it is unlocked while the vehicle is in motion.

- ▶ Make sure that the steering wheel is locked before driving off.
- ▶ Never unlock the steering wheel when the vehicle is in motion.

**⚠ WARNING** Risk of entrapment for children when adjusting the steering wheel

Children could injure themselves if they adjust the steering wheel.

- ▶ Never leave children unattended in the vehicle.
- ▶ When leaving the vehicle, always take the SmartKey with you and lock the vehicle.

**Adjusting the steering wheel**

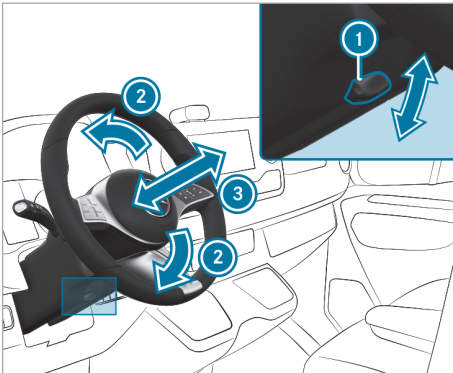

- ① Lever
- ② Steering column height
- ③ Steering column fore-and-aft adjustment

- ▶ **To unlock:** swing lever ① down as far as it will go. The steering wheel is unlocked.
- ▶ **To lock:** pull lever ① up as far as it will go. The steering wheel is locked.

**Switching the steering wheel heater on/off**

**Requirements:**

- The vehicle is switched on.

The steering wheel heater is switched on and off via a switch below the steering wheel.

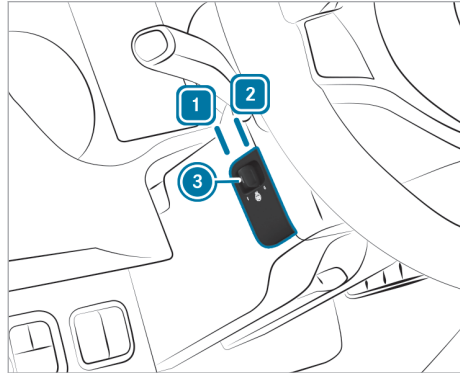

- ▶ **To switch on:** push the switch into position ①. If indicator lamp ③ lights up, the steering wheel heater is switched on.
- ▶ **To switch off:** push the switch into position ②.

When you switch the vehicle off, the steering wheel heater will switch off.

**Stowage areas**

**Overview of the front stowage compartments**

**Overview of the front storage compartments**

Observe the notes on loading the vehicle (→ page 164).

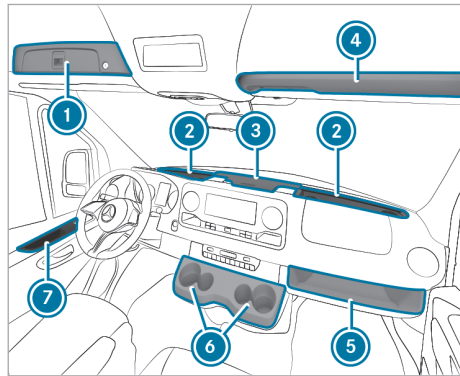

- ① Lockable compartment above windshield (subject to a maximum load of 4 lb (2 kg))
- ② Windshield storage compartment with two cup holders / ashtray stowage space  
Storage compartment with cover, depending on specification

- ③ Center console storage compartment with USB port, charging interface, NFC interface and 12 V socket
- ④ Storage compartment above windshield (subject to a maximum load of 5 lb (2.5 kg))
- ⑤ Front passenger side storage compartment (subject to a maximum load of 11 lb (5 kg))
- ⑥ Cup holder (→ page 66)
- ⑦ Storage compartment in the doors

#### Information about the bottle holder

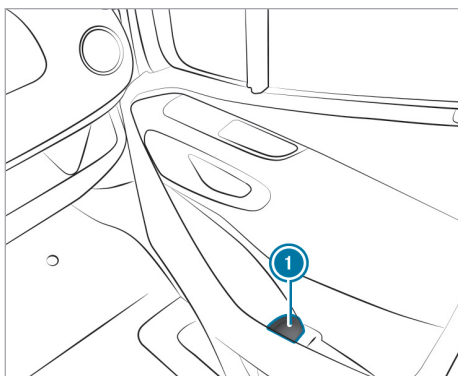

- ① Bottle holder in the front doors (example: front passenger door)

#### Cup holders

##### Overview of cup holders in the center console

**⚠ WARNING** - Risk of accident or injury when using the cup holder while the vehicle is moving

The cup holder cannot secure containers while the vehicle is moving.

If you use a cup holder while the vehicle is moving, the container may be flung around and liquids may be spilled. The vehicle occupants may come into contact with the liquid and if it is hot, they could be scalded. You could be distracted from traffic conditions and you may lose control of the vehicle.

- ▶ Only use the cup holder when the vehicle is stationary.
- ▶ Only use the cup holder for containers of the right size.

- ▶ Close the container, particularly if the liquid is hot.

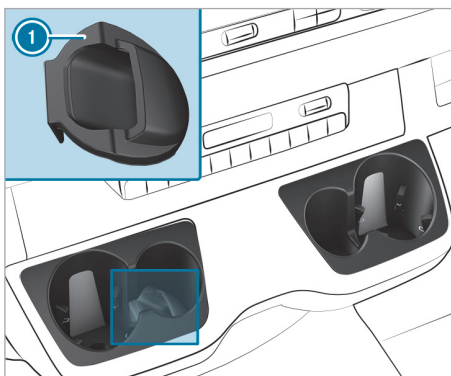

The cup holders for the driver and front passenger are in the center console.

Key holder ① for vehicles with a reduced antenna detection range (KEYLESS-START) is located in the driver's cup holder.

#### Ashtray and cigarette lighter

##### Using ashtrays

- ▶ Place the closed ashtray in a cup holder in the windshield stowage compartments.
- ▶ Check that the ashtray is seated securely.
- ⓘ Do not place the ashtray in the center console cup holders. It cannot sit securely here.

##### Using the cigarette lighter in the center console

**⚠ WARNING** Risk of fire and injury from hot cigarette lighter

You can suffer burns if you touch the hot heating element or the hot socket of the cigarette lighter.

In addition, flammable materials can catch fire if:

- you drop the hot cigarette lighter.
- children e.g. hold the hot cigarette lighter to objects.
- ▶ Always hold the cigarette lighter by the knob.
- ▶ Always make sure that the cigarette lighter is out of the reach of children.

- ▶ Never leave children unattended in the vehicle.

**Requirements:**

- The vehicle is switched on.

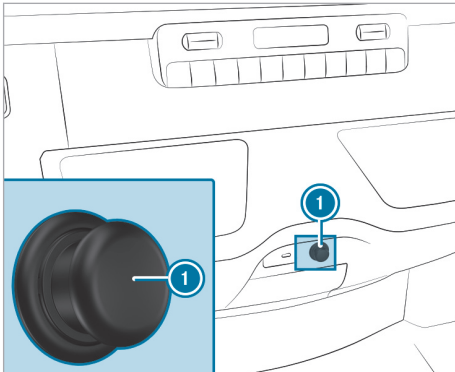

- ▶ Press in cigarette lighter ①. The cigarette lighter will pop out when the heating element is red-hot.

**Sockets**
**Using 12 V sockets**
**Requirements:**

- Only devices with a maximum power consumption of 180 W (15 A) may be connected.

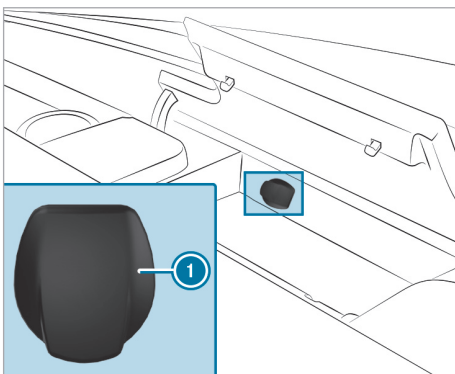
**12 V socket in the storage compartment**

- ▶ Open the lid of the storage compartment in the center console.
- ▶ Fold up cover ① of the socket.
- ▶ Insert the plug of the device.

- ① Depending on the vehicle equipment, the vehicle has additional 12 V sockets:

- in the lower control panel in the front center console
- in the driver's seat
- in the cargo compartment

**Notes on the 115 V socket**

- ⚠ **NOTE** Damage to the auxiliary battery due to full discharge

The auxiliary battery may become damaged if a device with too high a power output is connected when you leave the vehicle, or the auxiliary battery's charge level is low.

- ▶ Only connect devices up to a maximum of 150 W.
- ▶ Do not leave devices connected for longer than four hours.

Vehicles with an auxiliary battery have a run-on function. If you leave the vehicle, you can charge devices over a period of up to four hours. If the vehicle is switched on and off again during the run-on period, the run-on function starts again for another four hours.

**Using the 115 V socket in the center console**

- ⚠ **DANGER** Risk of fatal injuries due to a damaged connecting cable or a damaged socket

You could receive an electric shock if the connecting cable or the 115 V power socket is pulled out of the trim or is damaged or wet.

- ▶ Use only connecting cables that are dry and free of damage.
- ▶ When the vehicle is switched off, make sure that the 115 V power socket is dry.
- ▶ Immediately have the 115 V power socket checked or replaced at a qualified specialized workshop if it is damaged or has been pulled out of the trim.
- ▶ Never plug the connecting cable into a 115 V power socket that is damaged or has been pulled out of the trim.



**⚠ DANGER** Risk of death due to using the socket incorrectly

In particular, you could receive an electric shock:

- If you touch the inside of the socket
- If you insert unsuitable devices or objects into the socket

- ▶ Do not touch the inside of the socket.
- ▶ Only connect suitable devices to the socket.

**⚠ DANGER** Risk of fatal injuries due to electric shock

If you clean the 115 V socket with a wet cloth, you can get an electric shock.

There is a risk of fatal injury!

- ▶ Avoid the area around the 115 V socket when cleaning.

**Requirements**

- Only connect devices with a suitable plug which conforms to the standards specific to the country you are in.
- Only connect devices up to a maximum of 150 W.
- Do not use multiple socket outlets.

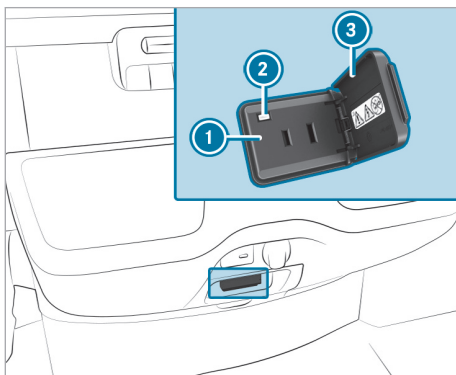

- ▶ Open flap ③.
- ▶ Insert the plug of the device into 115 V socket ①. When the on-board electrical system voltage is sufficient, indicator lamp ② lights up.

If you will not be using the 115 V power socket, keep the flap ③ closed.

**Wirelessly charging the mobile phone and coupling with the exterior antenna**

**Notes on wirelessly charging the mobile phone**

**⚠ WARNING** Risk of injury due to objects being stowed incorrectly

If objects in the vehicle interior are stowed incorrectly, they can slide or be thrown around and hit vehicle occupants. In addition, cup holders, open storage spaces and mobile phone receptacles cannot always retain all objects within.

There is a risk of injury, particularly in the event of sudden braking or abrupt changes in direction.

- ▶ Always store objects such that they cannot be thrown around in such situations.
- ▶ Always make sure that objects do not protrude from storage spaces, parcel nets or storage nets.
- ▶ Close the lockable storage spaces before starting a journey.
- ▶ Stow and secure objects that are heavy, hard, pointed, sharp-edged, fragile or too large in the cargo compartment.

Comply with the instructions for loading the vehicle (→ page 164).

**⚠ WARNING** Risk of fire from placing objects in the mobile phone storage compartment

Placing other objects in the mobile phone storage compartment could constitute a fire hazard.

- ▶ Apart from a mobile phone, do not place any other objects in the mobile phone storage compartment, especially those made of metal.

**! NOTE** Damage to objects caused by placing them in the mobile phone storage compartment

If objects are placed in the mobile phone storage compartment, these may be damaged by electromagnetic fields.

- ▶ Do not place credit cards, storage media, ski passes or other objects sensitive to electromagnetic fields in the mobile phone storage compartment.



**NOTE** Damage to the mobile phone stowage compartment caused by liquids

If liquids enter the mobile phone stowage compartment, the compartment may be damaged.

▶ Ensure that no liquids enter the mobile phone stowage compartment.

Observe the following notes on wireless charging:

- The charging function is available only when the drive system has been started.
- In some cases, it may not be possible to charge small mobile phones at every position of the mobile phone compartment.
- It may not be possible to charge large mobile phones that do not rest in the mobile phone receptacle.
- The mobile phone can warm up during the charging process. This depends on the applications (apps) currently running.
- For more efficient charging, the protective case should be removed from the mobile phone. Protective cases designed for wireless charging are an exception.
- When charging, the mat should be used if possible.

### Charging the mobile phone wirelessly in the front

#### Requirements:

- The mobile phone must be suitable for wireless charging.

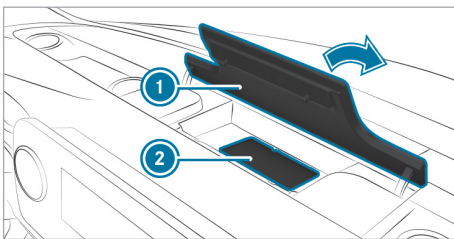

- ▶ Open the flap of stowage compartment ① above the media display.
- ▶ Place the mobile phone as centrally as possible with the display facing upwards on the marked surface of mat ②.  
When the charging symbol is shown in the multimedia system, the mobile phone is being charged.

Malfunctions during charging are shown in the media display of the multimedia system.

- ① The mat can be removed for cleaning, e.g. using clean, lukewarm water.

### Installing and removing the floor mats

**WARNING** Risk of accident due to objects in the driver's footwell

Objects in the driver's footwell may impede pedal travel or block a depressed pedal.

This will jeopardize the operating- and road safety of the vehicle.

- ▶ Stow all objects in the vehicle securely so that they cannot get into the driver's footwell.
- ▶ Make sure that there is always sufficient clearance for the pedals.
- ▶ Always install the floor mats securely and as prescribed.
- ▶ Do not use loose floor mats and do not place floor mats on top of one another.

#### Installing

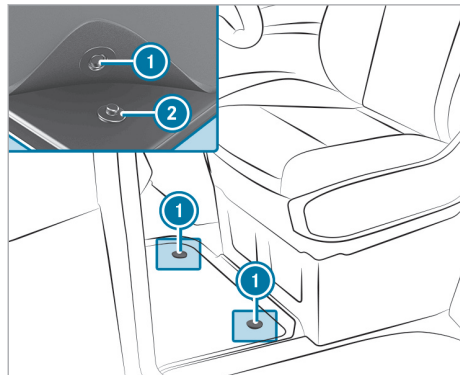

- ▶ Slide the seat backwards.
- ▶ Position the floor mat in the footwell so that it fits flush.
- ▶ Press studs ① onto holders ②, if applicable.
- ▶ Connect the installed driver and passenger footwell floor mats at the contact area.
- ▶ Adjust the seat.

**Removing**

- ▶ Slide the corresponding seat backwards and pull the floor mat off holders ②, if applicable.
- ▶ Remove the floor mat.

## Lighting

### Notes on adjusting the lights when driving abroad

#### Vehicles with halogen or static LED headlamps:

Changing the headlamps is not necessary. The legal requirements will also be fulfilled in countries with left- and right-hand traffic.

### Information about lighting systems and your responsibility

The vehicle's various lighting systems are only aids. The vehicle driver is responsible for adjusting the vehicle's lighting to the prevailing light, visibility, statutory conditions and traffic conditions.

## Light switch

### Operating the light switch

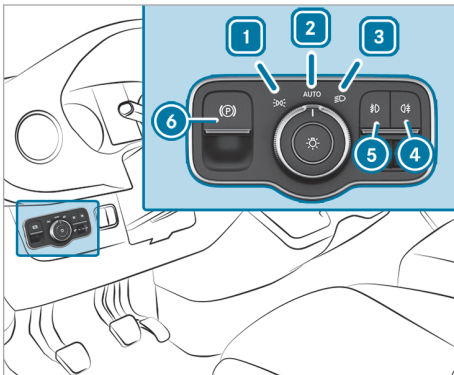

- ▶ **1** Activates or deactivates parking lamps and license plate and instrument lighting.
- ▶ **2** **AUTO** Activates or deactivates automatic driving lights/daytime running lamps (preferred light switch position).
- ▶ **3** Activates or deactivates low beam/high beam.
- ▶ **4** Activates or deactivates the front fog light.
- ▶ **5** Activates or deactivates the rear fog light.
- ▶ **6** Applies or releases the electric parking brake (→ page 116).

**i** If you hear a warning tone when exiting the vehicle, the lights may still be on.

**i** The turn signal light, the high beam and the headlamp flasher are operated with the combination switch (→ page 72).

**i** Leaving the parking lamps on for several hours drains the battery.  
If the battery is heavily discharged, the parking lamps will switch off automatically to enable the next vehicle start.

### Automatic driving lights function

**▲ WARNING** Risk of accident when the low beam is switched off in poor visibility

When the light switch is set to **AUTO**, the low beam may not be switched on automatically if there is fog, snow or other causes of poor visibility such as spray.

▶ In such cases, turn the light switch to .

The automatic driving lights are only an aid. Responsibility for vehicle lighting rests with you. Turn the light switch from **AUTO** to immediately in the event of fog, snow or spray. Otherwise, the driving lights will be temporarily interrupted.

To switch the automatic driving lights on:

- Turn the light switch to the **AUTO** position.  
Switch the power supply on: the side lights will automatically switch on or off depending on the brightness of the ambient light.

The daytime running lights will be switched on when the vehicle is started. The side lights and the low beam will also switch on or off depending on the brightness of the ambient light.

When the low beam is switched on, the indicator lamp on the instrument cluster will also switch on.

### Activating/deactivating the fog lights

#### Requirements:

- The light switch is in the or **AUTO** position.
- The vehicle has been switched on or started.

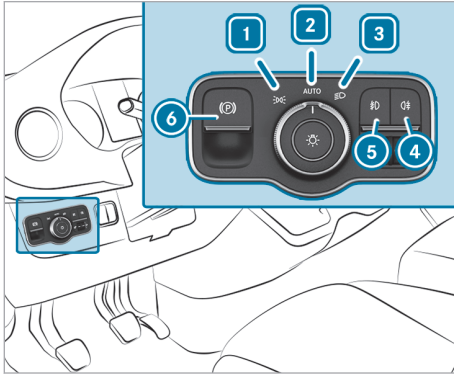

- ▶ **To switch the front fog light on or off:** press button ④.
- ▶ **To switch the rear fog light on or off:** press button ⑤.

Comply with the country-specific regulations for using the rear fog lamp.

### Adjusting headlamp range

#### Requirements:

- The vehicle has been started.

You can use the headlamp range adjuster to adjust the light cone of the headlamps to the vehicle's load condition. As the seats are occupied or the cargo compartment is loaded or unloaded, the light cone will change. This may cause visibility conditions to deteriorate and you could glare oncoming traffic.

- ① In vehicles with LED headlamps, the headlamp range is adjusted automatically.

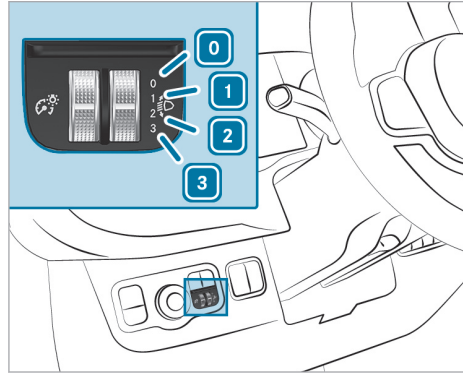

- ① Driver's seat and front passenger seat occupied
- ② Driver's seat and front passenger seat occupied, cargo compartment or loading area laden
- ③ Driver's seat and front passenger seat occupied and maximum permitted rear axle load being used

- ▶ Turn the headlamp range adjuster to the corresponding position.  
The road illumination should be 131.2 ft (40 m) to 328.1 ft (100 m) and the low beam must not glare oncoming traffic.
- ▶ If the vehicle is unladen, select position ①.

### Operating the combination light switch

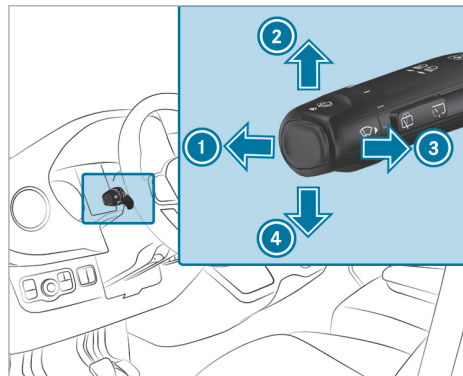

- ① High beam
- ② Right turn signal light

- ③ Headlamp flashing
- ④ Left turn signal light

▶ Use the combination switch to select the desired function.

### Switching on high beam

▶ Switch on the low beam (→ page 71).

▶ Push the combination switch forwards ①. The  indicator lamp on the instrument cluster will light up. The combination switch will return to its starting position.

① In the **AUTO** position, the high beam switches on only in darkness and when the vehicle is switched on.

▶ **To switch off:** push the combination switch forwards ① or briefly pull it in the direction of arrow ③ (the action for headlamp flashing switches high beam off). The  indicator lamp on the instrument cluster will go out. The combination switch will return to its starting position.

① **Vehicles with Highbeam Assist:** when High-beam Assist is active, it controls the activation and deactivation of the high beam (→ page 74).

### Headlamp flashing

▶ Briefly pull the combination switch in the direction of arrow ③.

### Turn signal light

▶ **To indicate:** push the combination switch in the required direction ② or ④ until it engages. When significant steering movements are made, the combination switch will automatically reset itself.

▶ **To indicate briefly:** tap the combination switch briefly in the required direction ② or ④. The corresponding turn signal lamp will flash three times.

### Switching the hazard warning light system on/off

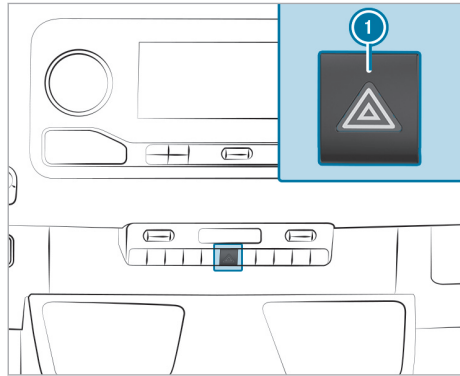

▶ Press button ①.

If you operate a turn signal indicator while the hazard warning light system is switched on, only the turn signal lamps on the relevant side of the vehicle will light up.

① The hazard warning light system will work even when the vehicle has been switched off.

### Cornering light function

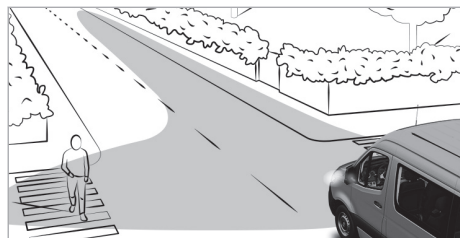

The cornering light improves the illumination of the road over a wide angle in the turning direction, e.g. enabling better visibility in tight bends.

The function is active under the following conditions:

- The speed is less than 37 mph (60 km/h) and the indicator has been switched on or the steering wheel is turned.
- The speed is between 37 mph (60 km/h) and 50 mph (80 km/h) and the steering wheel is turned.

The cornering light may still light up for a short time but will be switched off automatically after a maximum of three minutes.

-  When reverse gear is engaged, the lighting switches to the opposite side.

## Highbeam Assist

### Adaptive Highbeam Assist function

 **WARNING** Risk of accident despite Adaptive Highbeam Assist

Adaptive Highbeam Assist does not react to:

- Road users without lights, e.g. pedestrians
- Road users with poor lighting, e.g. cyclists
- Road users whose lighting is obstructed, e.g. by a barrier

On very rare occasions, Adaptive Highbeam Assist may fail to recognize other road users with their own lighting, or may recognize them too late.

In these, or in similar situations, the automatic high beam will not be deactivated or will be activated despite the presence of other road users.

- ▶ Always observe the road and traffic conditions carefully and switch off the high beam in good time.

Adaptive Highbeam Assist automatically switches between the following settings:

- Low beam
- High beam

The system detects that vehicle lights are approaching in the opposite direction or driving ahead of the vehicle.

At speeds greater than 19 mph (30 km/h), the system will switch to the following setting:

- If no other road users are detected, high beam will switch on automatically.

At speeds lower than 16 mph (25 km/h) or if there is sufficient street lighting, the system will switch to the following setting:

- High beam will automatically switch off.

### System limits

Adaptive Highbeam Assist cannot take the road, weather or traffic conditions into consideration.

The detection of obstacles may be restricted if:

- visibility is poor, e.g. in fog, heavy rain or snow.
- the sensors are dirty or obscured.

Adaptive Highbeam Assist is only an aid. You are responsible for ensuring correct vehicle lighting in accordance with the prevailing light, visibility and traffic conditions.

The system's optical sensor is located behind the windshield near the overhead control panel.

### Switching Highbeam Assist on/off

#### Requirements:

- The light switch is in the **AUTO** position.

- ▶ **To switch on:** switch on high beam using the combination switch.

When the high beam is switched on automatically in the dark, the  indicator lamp will light up on the instrument cluster display.

- ▶ **To switch off:** switch off high beam using the combination switch.

### Setting the exterior lighting switch-off delay time

#### Requirements

- The light switch is in the **AUTO** position.

Multimedia system:

- ▶  ▶ Settings ▶ Light
- ▶ Exterior Lighting Delay

- ▶ Set a switch-off delay time.

When the vehicle is switched off, the exterior lighting will be activated for the set time.

### Activating and deactivating the surround lighting

Multimedia system:

- ▶  ▶ Settings ▶ Light
- ▶ Locator Lighting

- ▶ Activate or deactivate the function.





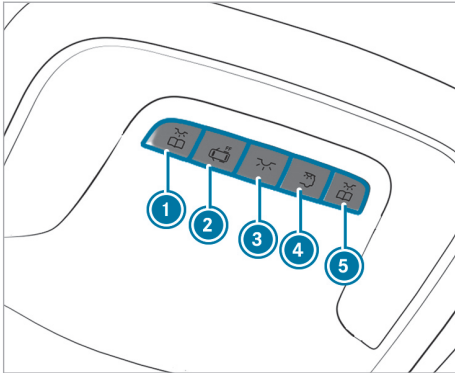

The surround lighting will remain on for 40 seconds after the vehicle is unlocked. When you start the vehicle, the surround lighting will be deactivated and the automatic driving lights activated.

## Adjusting the interior lighting

### Adjusting the interior lighting



Versions 1 to 4

- ▶ ①  Switches the front-left reading lamp on/off
- ▶ ②  **To switch off the automatic interior lighting control:** press the  button. The interior lighting will switch on automatically if you:
  - Unlock the vehicle
  - Open a door
- ▶ ③  Switches the (front) interior lighting on/off.
- ▶ ④  Switches the rear passenger compartment / cargo compartment lamp on/off (not assigned depending on the vehicle equipment).
- ▶ ⑤  Switches the front-right reading lamp on/off

### Adjusting the interior lighting for body manufacturer add-on equipment

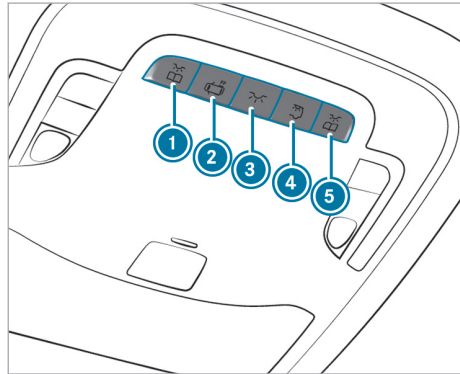

- ▶ **To switch the front left reading lamp on/off:** press button ①.
- ▶ **To deactivate automatic interior lighting control:** press button ②. Interior lighting control will switch on automatically if you do the following, for example:
  - Unlock the vehicle
  - Open a door
- ▶ **To switch the front interior lighting on/off:** press button ③.
- ▶ **To switch body manufacturer lamps on/off:** press button ④ (not assigned depending on the vehicle equipment).
  - Your vehicle may be equipped with a functional feedback system:  will light up in red if the body manufacturer lamps are switched on.
  - If the body manufacturer lamps have been switched on manually, they will also remain switched on for an extended period of time after locking.
    - ① This period of time is shortened if there is undervoltage in the starter battery.
    - ① If the body manufacturer lamps have been switched off automatically to protect the battery, restart the vehicle before switching them on again.
    - ① The body manufacturer lamps can be switched on only when the battery voltage is stable.
- ▶ **To switch the front right reading lamp on/off:** press button ⑤.

### Switching the rear passenger compartment interior lighting on/off

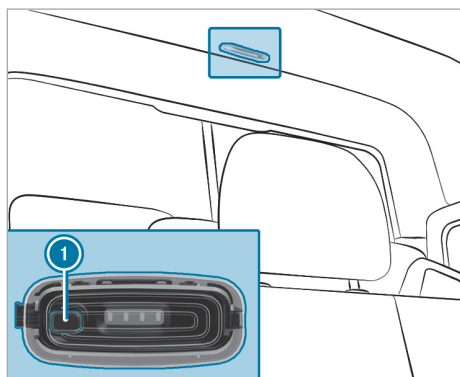

- ▶ ① Switches rear passenger compartment/cargo compartment lamp on or off

### Motion detector

**⚠ WARNING** Risk of injury due to laser beam of the motion detector

The motion detector emits non-visible radiation from LEDs that are classified as class 1M lasers.

This may damage the retina in the following situations:

- If you look directly into the unfiltered laser beam of the motion detector for an extended period.
- If you look directly into the laser beam of the motion detector with optical instruments, such as glasses or magnifying glasses.

- ▶ Never look directly into the motion detector.

The motion detector is located in the cargo compartment behind the partition, in the middle of the roof.

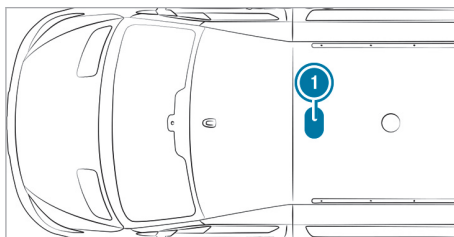

- ① Position of motion detector

If the vehicle is equipped with a motion detector, the cargo compartment lamp is also activated via the motion detector.

If the motion detector detects movement in the cargo compartment while the vehicle is stationary, the cargo compartment lamp will switch on for approximately two minutes.

The cargo compartment lamp will be switched on via the motion detector in the following situations:

- The vehicle is stationary, the parking brake is applied and you are not depressing the brake pedal.
- The selector lever is in position **P** and you are not depressing the brake pedal.
- The vehicle has not been locked from the outside using the key.

If no change to the vehicle (e.g. a door opening) is detected over several hours, the motion detector will automatically switch off. This prevents the battery from discharging.

### Adjusting ambient lighting

Multimedia system:

→ [Home] → Comfort → Ambient Light

#### Setting the color

- ▶ Select **Color**.
- ▶ Select **Monochrome** or **Multi-color**.
- ▶ Set the desired color or color scheme.

#### Adjusting the brightness

- ▶ Select **Brightness**.
  - ▶ Adjust the brightness.
- ① Depending on the ambient light, the ambient lighting will automatically switch between day and night modes.



### Activating brightness for zones

- ▶ Select **Brightness**.
- ▶ Deactivate **Link Zones**.  
The **Direct**, **Indirect** and **Accents** zones can be set separately.

### Activating effects

**⚠ WARNING** Risk of accident if ambient lighting and active ambient lighting effects are not switched on

The warning assistance effects will be fully active only when the relevant driving or driving safety systems are activated on the Driving Assistance menu.

- ▶ Make sure that the relevant driving or driving safety systems are activated.

**i** Observe the notes on driving systems and your responsibility; you may otherwise fail to recognize dangers (→ page 118).

- ▶ Select **Effects**.
- ▶ Activate the desired effect.

**i** Depending on the vehicle equipment, different effects are available.

#### Operating feedback effects

- **Climate:** If changes are made to the temperature setting in the vehicle, the color of the ambient light will change briefly.
- **Greeting:** When you get into the vehicle, a special color animation will play.

### Multi-color Animation

- The chosen color combination will change at predefined intervals.

### Switching the interior lighting switch-off delay time on/off

Multimedia system:

- ➔  ➔ **Settings** ➔ **Light**
- ➔ **Interior/Exterior Lighting**
- ➔ **Interior Lighting Switch-off Delay**

▶ Activate or deactivate **Interior Lighting Switch-off Delay**.

If this function is active, the interior lighting will be switched on for a short time after the end of the journey.

### Changing bulbs

#### Instructions for replacing illuminants

**⚠ WARNING** Risk of burns from hot component parts whilst replacing a bulb

Bulbs, lamps and plug connectors can become very hot during operation.

When replacing a bulb, you could burn yourself on these component parts.

- ▶ Allow the component parts to cool down before replacing the bulbs.

#### Important safety notes

- Before changing the bulbs, switch off the vehicle's lighting system. This will prevent a short circuit.
- Use only spare bulbs of the same type and with the correct voltage.
- Use bulbs only in enclosed lamps that have been designed for them.
- Do not use any illuminant that has been dropped or has scratches on its glass tube. Otherwise, the illuminant may explode.
- The illuminant may explode under the following conditions:
  - if it is hot and you touch it
  - if you drop it
  - if you scratch it
- Stains on the glass tube will reduce the service life of the illuminant. Do not touch the glass tube with your bare hands. If necessary, clean the glass tube with alcohol or spirits while it is cold and wipe it down with a lint-free cloth.
- Protect light bulbs from humidity and do not bring them into contact with liquids.

Always ensure the bulbs are firmly secured.

If your vehicle is equipped with LED modules, you can check this as follows: the light cone will move from top to bottom and back again when the vehicle starts. For this to work, low beam needs to have been switched on before the vehicle is started.

Bulbs and lamps are major elements in vehicle safety. Therefore, ensure that they are always working. Have the headlamp setting checked regularly.

If the new light source also does not light up, consult a qualified specialist workshop.

## Replacing front light bulbs (vehicles with halogen headlamps)

### Overview of illuminant types

You can replace the following light sources.

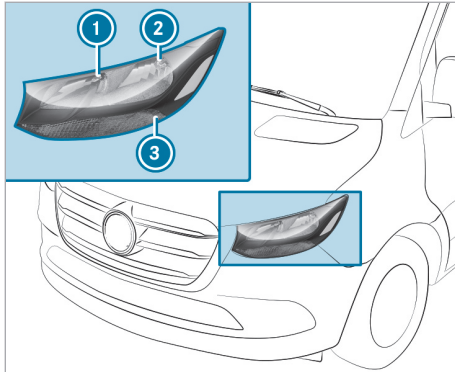

Halogen headlamps

- ① High beam/daytime running lights: H15 55 W/15 W
- ② Low beam/perimeter light: H7 55 W/W 5 W
- ③ Turn signal light: 3457 NAK 28 W

### Replacing halogen headlamps

#### Requirements

- **Low beam:** light source type H7 55 W
- **High beam/daytime running lights:** light source type H15 55 W/15 W
- **Perimeter lights:** light source type W 5 W
- **Turn signal lights:** light source type 3457 NAK 28 W

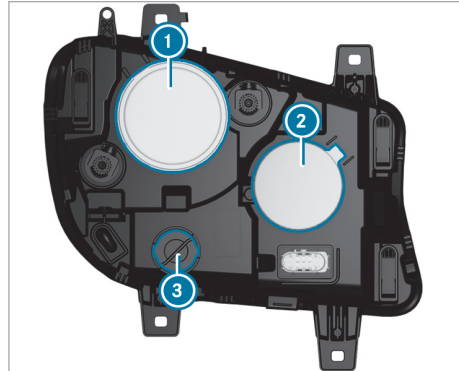

- ① Low beam/perimeter light housing cover
- ② High beam/daytime running lights housing cover
- ③ Turn signal light socket

- ▶ Switch off the lighting system.
- ▶ **Low beam/perimeter light:** pull housing cover ① rearward to remove it.
- ▶ Pull the socket rearward to remove it.
- ▶ Remove the light source from the socket.
- ▶ Insert the new light source into the socket such that the base of the bulb rests fully against the base of the socket.
- ▶ Align and insert the socket.
- ▶ Attach housing cover ①.
- ▶ **High beam/daytime running lights:** pull housing cover ② rearward to remove it.
- ▶ Turn the socket counter-clockwise and pull it out.
- ▶ Remove the light source from the socket.
- ▶ Insert the new light source into the socket such that the base of the bulb rests fully against the base of the socket.
- ▶ Insert the socket and turn it clockwise.
- ▶ Attach housing cover ②.
- ▶ **Turn signal light:**
- ▶ Turn socket ③ counter-clockwise and remove it.
- ▶ Gently turn the illuminant counter-clockwise and take it out of the socket.
- ▶ Insert the new illuminant into the socket and turn it clockwise.
- ▶ Insert socket ③ and turn it clockwise.

## Replacing rear bulbs

### Overview of rear illuminant types

You can replace the following light sources.

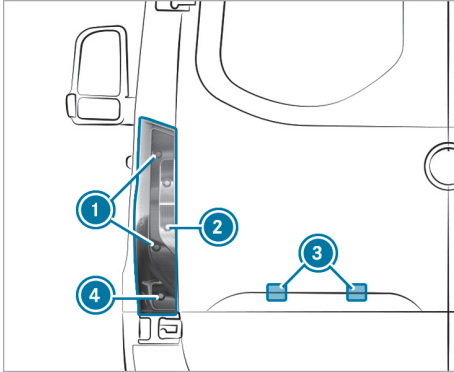

Vehicles with standard tail lamps

- ① Brake lights/tail lamps/perimeter lights: P 21 W
- ② Backup lamp: P 21 W
- ③ License plate lamp: W 5 W
- ④ Rear fog light: P 21 W

You can replace the following light sources.

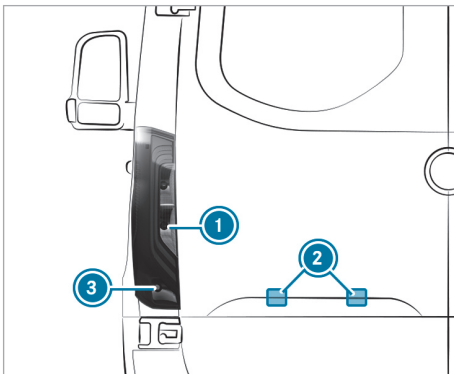

Vehicles with partial LED tail lamps

- ① Backup lamp: P 21 W
- ② License plate lamp: W 5 W
- ③ Rear fog light: P 21 W

## Changing the tail lamp

### Requirements:

- **Brake light/tail light/perimeter light:** light source type P 21 W
- **Backup lamps:** light source type P 21 W
- **Rear fog lights:** light source type P 21 W

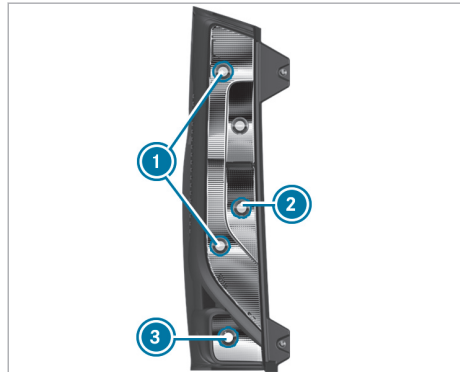

- ① Brake light/tail light/perimeter light
- ② Backup lamp
- ③ Rear fog light

- ▶ Switch off the lighting system.
- ▶ Open the rear-end door.

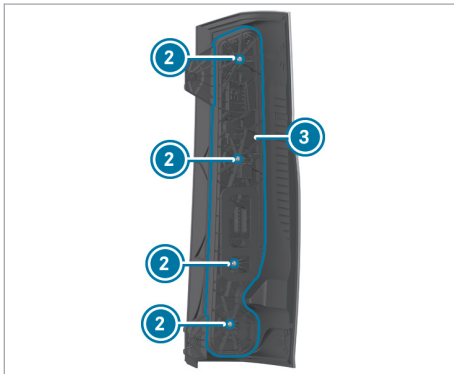
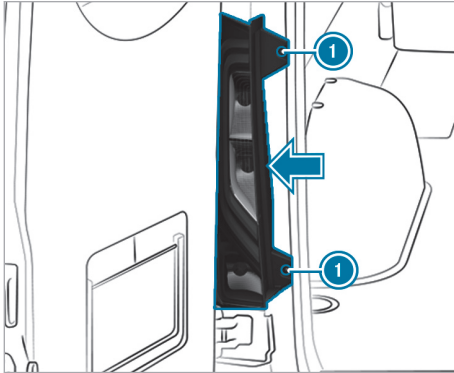

### Removing

- ▶ Remove screws ① and pull out the tail lamp in the direction of the arrow.
- ▶ Remove the plug from bulb mount ③.
- ▶ Remove the screws ② and remove the bulb mount ③ from the tail lamp.
- ▶ Gently turn the light source counter-clockwise and take it out of the socket.
- ▶ Insert the new light source into the socket and turn it clockwise.

### Installing

- ▶ Set bulb mount ③ on the tail lamp and screw in screws ②.
- ▶ Press the plug into the bulb mount ③.
- ▶ Insert the tail lamp and screw in the screws ①.

### License plate lamp

#### Requirements:

- **License plate lamp:** light bulb type W 5 W



- ▶ Switch off the lighting system.
- ▶ Place a screwdriver, for example, at opening ② between lamp ③ and panel ① and carefully pry off the lamp ③.
- ▶ Remove lamp ③ from panel ①.
- ▶ Rotate the bulb holder by around 45° and detach it from the lamp.
- ▶ Remove the light bulb.
- ▶ Insert the new bulb into the bulb holder.
- ▶ Insert the bulb holder into the lamp and rotate it by around 45°.
- ▶ Insert the lamp into the panel opening until it engages.

### Replacing interior light bulbs

#### Replacing rear interior lamps

#### Requirements

- ⓘ For the standard bulb failure indicator function to work correctly, only light bulbs that are the same type and power as those installed during production may be used.

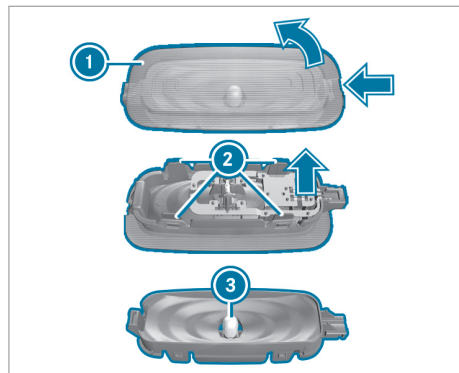

- ▶ Switch off the interior lighting.
- ▶ Press in the catch spring of lens ① with a suitable object, e.g. a screwdriver, and then lever off the lens with the lamp housing.
- ▶ **To remove the lens from the lamp housing:** press the lugs of lens ② inwards.
- ▶ Remove light bulbs ③ from the lamp housing.
- ▶ Insert the new light bulb.
- ▶ Position the lens on the lamp housing and engage it.
- ▶ Align the lens with the lamp housing and engage it.

### Windshield wipers

#### Switching the windshield wipers on and off

##### Requirements:

- The power supply is switched on.

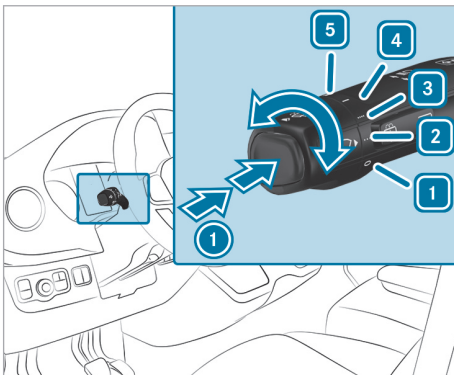

- ① Single wipe/wiping with washer fluid
- 1 Windshield wipers off
- 2 Intermittent wiping, normal  
Vehicles with rain sensors: automatic wiping, normal
- 3 Intermittent wiping, frequent  
Vehicles with rain sensors: automatic wiping, frequent
- 4 Continuous wiping, slow
- 5 Continuous wiping, fast

- ▶ Turn the combination switch to the corresponding position 1 - 5.
- ▶ **Single wipe:** press the button on the combination switch in the direction of arrow ⑥ as far as the first pressure point.

- ▶ **Washing:** press the button on the combination switch in the direction of arrow ⑥ as far as the second pressure point.

#### Switching the rear window wiper on and off

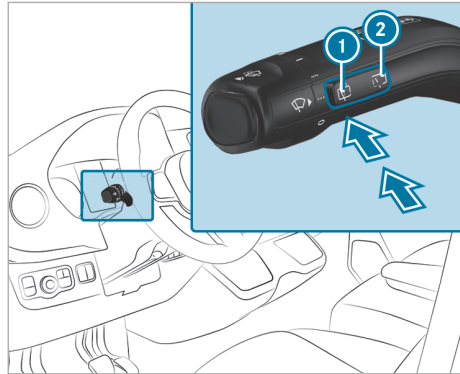

- ① Single wipe/wash
- ② Intermittent wiping

- ▶ **Single wipe:** press button ① to the pressure point.
- ▶ **Wiping with washer fluid:** press button ① beyond the pressure point.
- ▶ **To switch intermittent wiping on or off:** press button ②.  
The symbol will appear on the instrument cluster when the rear window wiper is switched on.

#### Replacing the windshield wiper blades

**⚠ WARNING** Risk of becoming trapped if the windshield wipers are switched on while wiper blades are being replaced

If the windshield wipers begin to move while you are changing the wiper blades, you can be trapped by the wiper arm.

- ▶ Always switch off the windshield wipers and vehicle before changing the wiper blades.

**⚠ WARNING** Risk of injury from using the windshield wipers when the hood is open

If the windshield wipers start moving when the hood is open, you could be trapped by the wiper linkage.

- ▶ Always switch off the windshield wipers and vehicle before opening the hood.

### Replacing the wiper blades

- ❶ If the wiper blades are worn out, they will no longer wipe the windshield properly. Replace the wiper blades twice a year, preferably in spring and fall.

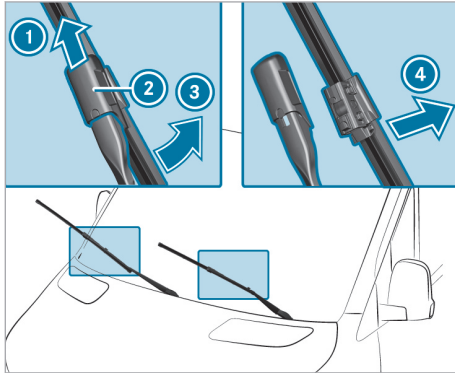

- ▶ Fold wiper arm ❸ away from the windshield.
- ▶ Hold wiper arm ❸ and turn the wiper blade away from wiper arm ❸ in the direction of the arrow as far as it will go.
- ▶ Slide catch ❷ upwards in the direction of the arrow until it engages.
- ▶ Fold the wiper blade back onto the wiper arm.
- ▶ Remove the wiper blade ❶ from the wiper arm.
- ▶ Insert new wiper blade ❶ in the holder on wiper arm ❸.

When doing so, take into account the different lengths of the wiper blades:

- Driver's side: long wiper blade
- Front passenger side: short wiper blade
- ▶ Slide catch ❷ downwards until it engages.
- ▶ Fold wiper arm ❸ back onto the windshield.

### Replacing the windshield wiper blades (WET WIPER SYSTEM)

- ⚠ **WARNING** Risk of becoming trapped if the windshield wipers are switched on while wiper blades are being replaced

If the windshield wipers begin to move while you are changing the wiper blades, you can be trapped by the wiper arm.

- ▶ Always switch off the windshield wipers and vehicle before changing the wiper blades.

- ⚠ **WARNING** Risk of injury from using the windshield wipers when the hood is open

If the windshield wipers start moving when the hood is open, you could be trapped by the wiper linkage.

- ▶ Always switch off the windshield wipers and vehicle before opening the hood.

### Replacing the wiper blades

- ❶ If the wiper blades are worn out, they will no longer wipe the windshield properly. Replace the wiper blades twice a year, preferably in spring and fall.

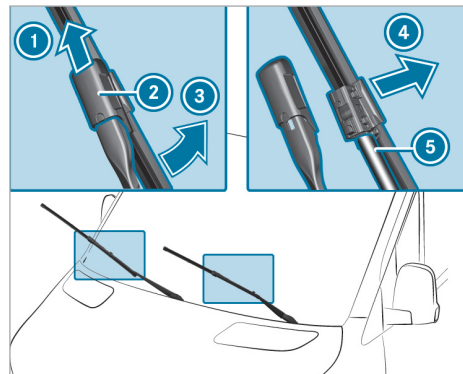

- ▶ Fold wiper arm ❸ away from the windshield.
- ▶ Hold wiper arm ❸ and turn the wiper blade away from wiper arm ❸ in the direction of the arrow as far as it will go.
- ▶ Slide catch ❷ upwards in the direction of the arrow until it engages.
- ▶ Remove wiper blade ❶ from the wiper arm in the direction of arrow ❹.

- ▶ Carefully remove hose ⑤ from the wiper blade.
- ▶ Attach hose ⑤ to the new wiper blade.
- ▶ Insert new wiper blade ① in the holder on wiper arm ③.

When doing so, take into account the different lengths of the wiper blades:

- Driver's side: long wiper blade
- Front passenger side: short wiper blade
- ▶ Slide catch ② downwards until it engages.
- ▶ Fold the wiper blade back onto the wiper arm.
- ▶ Fold wiper arm ③ back onto the windshield.

### Replacing the rear window wiper blades

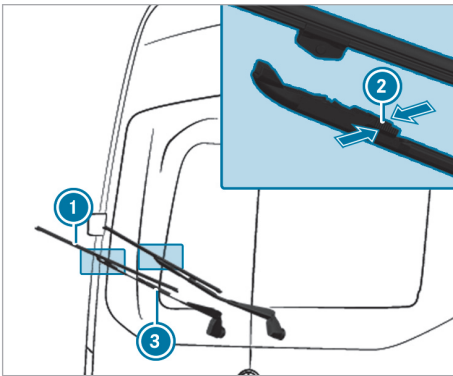

- ▶ Fold wiper arm ③ away from the rear window.
- ▶ Press both retaining clips ② together in the direction of the arrow and swivel the wiper blade away from the wiper arm.
- ▶ Pull wiper blade ① upwards out of the holder on wiper arm ③.
- ▶ Insert new wiper blade ① in the holder on wiper arm ③.
- ▶ Push new wiper blade ① onto wiper arm ③ until the retaining clips engage.
- ▶ Fold wiper arm ③ back onto the rear window.

## Mirrors

### Operating the outside mirrors

- ⚠ **WARNING** Risk of accident due to adjusting the vehicle settings while the vehicle is in motion

You could lose control of the vehicle in the following situations in particular:

- If you adjust the driver's seat, the head restraint, the steering wheel or the mirror while the vehicle is in motion
- If you fasten your seat belt while the vehicle is in motion

▶ Before starting the vehicle: in particular, adjust the driver's seat, head restraint, steering wheel and mirror, and fasten your seat belt.

- ⚠ **WARNING** Risk of accident due to misjudgment of distance when using the front-passenger mirror

The outside mirror on the front passenger side reflects objects on a smaller scale. The objects in view are in fact closer than they appear.

▶ Therefore, always look over your shoulder to check the actual distance between you and the road users traveling behind you.

### Adjusting the outside mirrors manually

- ▶ Adjust the outside mirrors to the correct position manually.
- ▶ **To engage an outside mirror that has been pushed out of position:** push the outside mirror into position manually.

### Adjusting the outside mirrors electrically

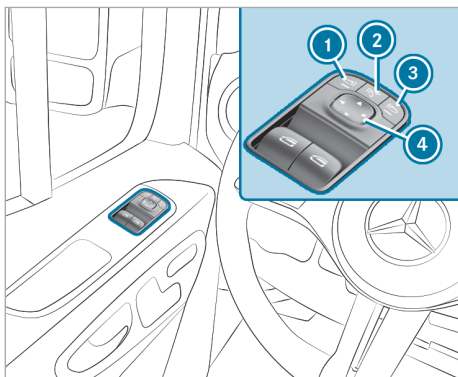

Example image

**!** **NOTE** Damage to the electric outside mirrors due to folding in by hand or by force

If the electric outside mirrors are folded in or out manually, the outside mirrors may be damaged and will not engage properly.

If the outside mirrors are not folded when you have the vehicle washed at an automatic car wash, the washing brushes may forcibly fold in and damage the outside mirrors.

- ▶ Fold the outside mirrors in and out electrically only.
- ▶ Fold in the outside mirrors before having the vehicle washed at an automatic car wash.

▶ Before setting off, switch on the power supply or the vehicle.

▶ **To fold in or out:** briefly press button ②.

▶ **To select:** use button ① or ③ to select the outside mirror to be adjusted.

▶ **To adjust:** use button ④ to set the position of the mirror glass.

▶ **To engage an outside mirror that has been pushed out of position:** press and hold button ②.

You will hear a click and the mirror will audibly engage in position. The outside mirror will be set to the correct position.

### Resetting the outside mirrors

① If the battery has been disconnected or completely discharged, the outside mirrors must

be reset. Only then will the automatic mirror folding function work properly.

- ▶ Switch on the power supply or the vehicle.
- ▶ Briefly press button ②.

### Heating the outside mirrors

▶ **Vehicles without a rear window heater:** at low temperatures, the mirror heater will switch on automatically once the vehicle has been started.

▶ **Vehicles with a rear window heater:** at low temperatures, the mirror heater will switch on automatically once the vehicle has been started. The mirror heater can also be switched on together with the rear window heater using the rear window heater button.

### Using the digital inside rearview mirror

The vehicle may be equipped with a digital inside rearview mirror. This uses a camera on top of the roof at the rear to provide a better view to the rear. The inside rearview mirror can be used either as a standard inside rearview mirror or as a display.

To prevent glare from the digital inside rearview mirror, first set the digital inside rearview mirror as the standard inside rearview mirror.

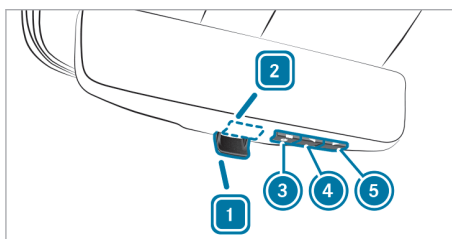

Digital image noise may occur on the display under certain circumstances in unfavorable ambient light.

Certain types of sunlight, e.g. sun low on the horizon or light from another intense light source, can reduce the display's contrast and cause it to become too bright. In such situations, objects on the display may be obscured or difficult to see. In these cases, be particularly careful and adapt your driving style accordingly.

Drivers must always wear the necessary personal visual aids required for them to drive a vehicle.

Drivers with presbyopia (age-related long-sightedness) should, if necessary, wear visual aids with



multifocal lenses to be sufficiently able to see traffic including via the displays.

- ❗ If the camera on top of the roof at the rear is dirty, the image may be impaired. In this case, clean the camera manually with a damp cloth. Observe the notes on cleaning the digital inside rearview mirror (→ page 176).

- ▶ **To use the standard inside rearview mirror:** move the switch to position **1**.
- ▶ **To use the display:** move the switch to position **2**.

### Adjusting the display brightness

- ❗ The digital inside rearview mirror is equipped with light sensors on the front and back and automatically adjusts the brightness of the display to the ambient light. Do not cover the light sensors, e.g. with a sticker.

- ▶ Press menu button **3** once.
  - ▶ Press button **4** to reduce the display brightness.
- or
- ▶ Press button **5** to increase the display brightness.

### Adjusting the angle of the camera

- ▶ Press menu button **3** twice.
  - ▶ Press button **4** to move the angle downwards.
- or
- ▶ Press button **5** to move the angle upwards.

### Activating and deactivating the rear view camera image

The vehicle may be equipped with a rear view camera with image in the inside rearview mirror.

- ▶ To activate, put the vehicle in reverse gear or press button **5**.
- ▶ To deactivate, take the vehicle out of reverse gear or press button **5** again.

### Error mode of the digital inside rearview mirror

If a system error occurs, e.g. if the camera fails, a crossed-out camera will appear at the top left of the display and no camera image will be visible in the mirror.

- ▶ Switch to the standard inside rearview mirror if there is a system error.

If a system error occurs, a crossed out camera with the number 2 will appear on the left side of the display. In this case, no camera image is available for maneuvering.

### Dimming the inside rearview mirror

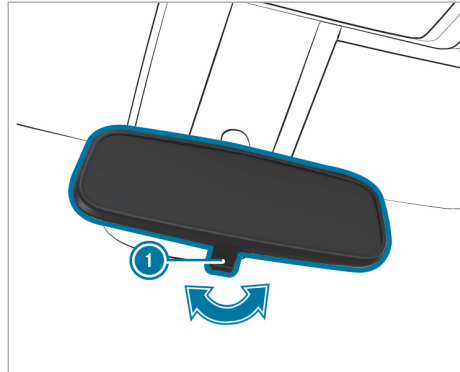





- ▶ Fold anti-glare lever **1** in the direction of the arrow.

If the vehicle is equipped with a rear view camera with image in the inside rearview mirror and a sys-

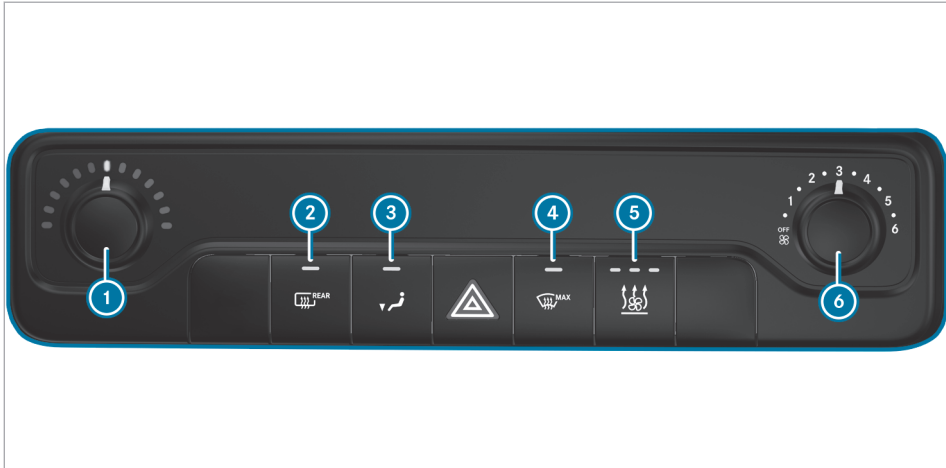
## Overview of climate control systems

### Heating system overview



- ① Sets the temperature
- ②  Switches the rear window defroster on/off (→ page 91)
- ③  Switches footwell air distribution on/off
- ④  Switches windshield defrosting on/off (→ page 90)
- ⑤  Vehicle switched on: Max Comfort mode cut-in; Vehicle switched off: Pre-entry climate control
- ⑥ Sets the airflow
- ① The indicator lamps on the buttons signal that the functions in question have been activated.

## TEMPMATIC overview

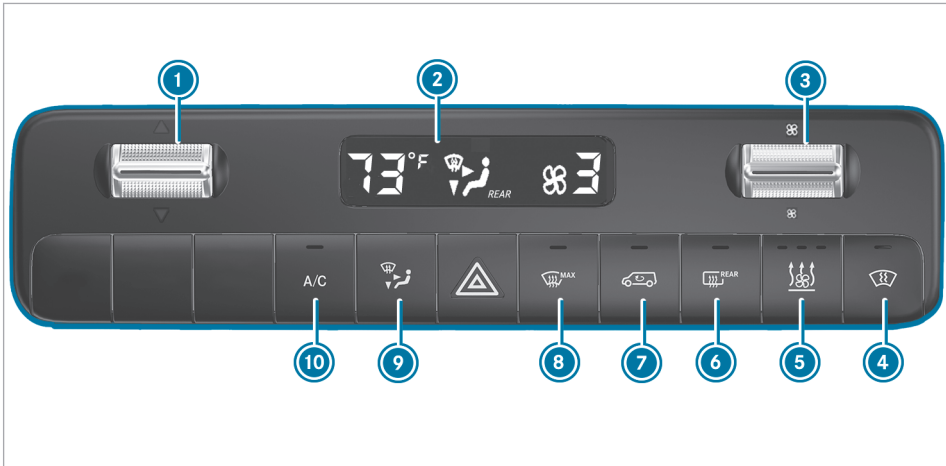

- ① Sets the temperature
  - ② Display
  - ③ Sets the airflow
  - ④ Vehicles with windshield heater: switches the windshield heater on/off (→ page 91)
  - ⑤ Vehicle switched on: Max Comfort mode cut-in; Vehicle switched off: Pre-entry climate control
  - ⑥ Vehicles with rear window defrosters: switches the rear window defroster on/off (→ page 91)
  - ⑦ Switches air-recirculation mode on/off (→ page 90)
  - ⑧ Switches windshield defrosting on/off (→ page 90)
  - ⑨ Sets the air distribution (→ page 90)
  - ⑩ Switches the A/C function on/off (→ page 89)
- ⓘ The indicator lamps on the buttons signal that the functions in question have been activated.

## THERMOTRONIC overview

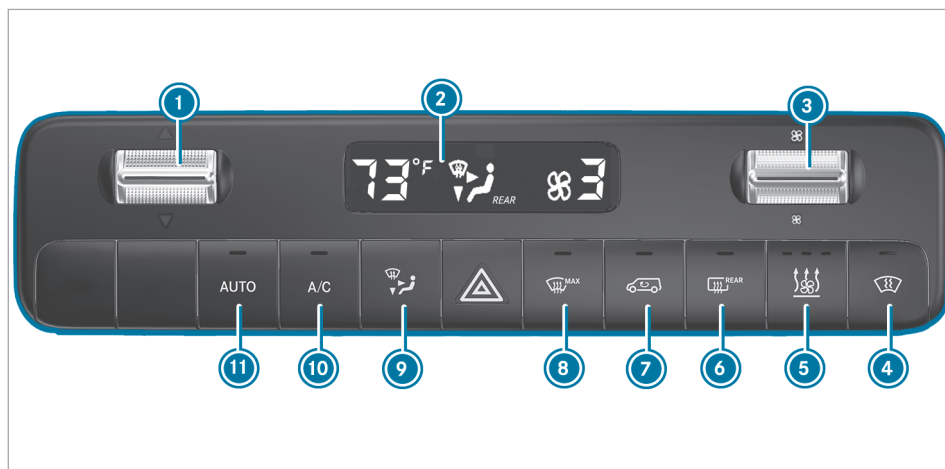

- ① Sets the temperature
  - ② Display
  - ③ Sets the airflow
  - ④ Vehicles with windshield heater: switches the windshield heater on/off (→ page 91)
  - ⑤ Vehicle switched on: Max Comfort mode cut-in; Vehicle switched off: Pre-entry climate control
  - ⑥ Vehicles with rear window defrosters: switches the rear window defroster on/off (→ page 91)
  - ⑦ Switches air-recirculation mode on/off (→ page 90)
  - ⑧ Switches windshield defrosting on/off (→ page 90)
  - ⑨ Sets the air distribution (→ page 90)
  - ⑩ Switches the A/C function on/off (→ page 89)
  - ⑪ Sets front climate control to automatic mode (→ page 90)
- ① The indicator lamps on the buttons signal that the functions in question have been activated.

### Operating climate control systems

#### Notes on energy-saving air-conditioning

Using the heating and climate control functions has a direct effect on the vehicle's range. For this reason, depending on the selected drive program,

(→ page 104) the heating/air-conditioning output will automatically be reduced.

Drive program	Vehicle characteristics
(Comfort)	Normal heating and air-conditioning output
(ECO)	Reduced heating and air-conditioning output
(MAX Range)	Heavily reduced heating and air-conditioning output

Depending on the vehicle's equipment, you can use MaxComfort mode to set an increased heating and air-conditioning output.



- ① To cool the high-voltage battery in very high outside temperatures, the cooling of the vehicle interior can be automatically reduced or switched off for a short time.
- In drive program (ECO), the best possible heating output is achieved in Auto mode (THERMOTRONIC) or with a low to moderate blower setting.
- In drive programs (ECO) and (MAX Range), there may be an increased risk of fogging up. If the windows fog up, you should increase the blower setting and select drive program (Comfort) if necessary. Switch on the "demist windshield" function as well if you need to (→ page 91).

A reduction in the heating/air-conditioning output may mean that it will take longer than usual to

reach the desired vehicle interior temperature or that it cannot be reached at all.

### MaxComfort mode



Depending on its equipment, your vehicle may have a MaxComfort mode.

When the vehicle is switched on, you can activate MaxComfort in all drive programs by pressing the  button on the air-conditioning control panel. The maximum output of the heating/air-conditioning system will be activated in this mode. This makes it possible to heat the vehicle more quickly, but can have a negative impact on range. The function is switched on when the indicator lamp on the  button is lit up.

### Energy-saving mode (Cargo Van)

Depending on the vehicle's equipment, it may have an energy-saving mode to reduce energy consumption when the vehicle is switched on.

When energy-saving mode is activated, the output of the heating/air-conditioning system will be significantly reduced. The display on the instrument cluster will show a message reading **Heating/Climate Control Energy-saving Active** briefly and the  symbol will be displayed permanently.

Energy-saving mode will be activated in drive programs  and  if:

- Front doors are opened immediately after the vehicle stops
- The front windows or doors are open for an extended period of time

 Energy-saving mode will remain active for a few minutes even after the front doors have closed.

By briefly switching on the "demist windshield" function (→ page 90), you can deactivate energy-saving mode for a certain period of time. When the "demist windshield" function is switched on, energy-saving mode will always be deactivated.

Energy-saving mode will automatically be deactivated:

- at speeds above approximately 43 mph (70 km/h)
- when the interior temperature falls below a certain level

In addition, comply with the following air-conditioning instructions in order to minimize energy consumption:

- Select as low a blower setting as possible.
- Use the "demist windshield" function only for a brief period until the windshield is clear again.
- Vehicles with an air-conditioning system: ventilate the vehicle for a short time in warm weather. To achieve quicker cooling, briefly switch the climate control to air-recirculation mode. This will accelerate the cooling process and the desired vehicle interior temperature will be reached more quickly.
- Vehicles with seat heating: using the seat heating in conjunction with a medium vehicle interior temperature will result in lower fuel consumption than selecting a high vehicle interior temperature.

### Switching the climate control system on/off

 **To switch on:** set the airflow to 1 or higher.

 **To switch off:** set the airflow to 0 or **OFF**. **OFF** will appear on the climate control system display.

 When the climate control system is switched off, the windows may fog up more quickly. Switch the climate control system off only briefly.

### Switching the A/C function on/off

#### Requirements:

- The climate control system has been switched on (→ page 89).

The A/C function controls the climate and dries the air inside the vehicle.

 Press the  button.

 Switch off the A/C function only briefly. Otherwise, the windows could fog up more quickly.

 Condensation may leak from the underside of the vehicle in cooling mode. This is not a sign of a defect.

### Automatically regulating climate control

#### Requirements:



- The climate control system has been switched on (→ page 89).

#### Switching on automatic climate control

In automatic mode, the temperature, airflow and air distribution are regulated and kept constant.

- Press the **AUTO** button.  
The display will show the temperature. The airflow and air distribution will disappear from the display.

#### Switching off automatic climate control

- Use the  rocker switch to change the airflow setting or the  button to change the air distribution (→ page 90).  
The other setting will remain unaffected by the change.





### Information on the air distribution settings

The symbols on the display indicate the vents through which the air is being directed.







Heating system

-  Directs air to the footwell vents

TEMPMATIC

-  Defroster and center air vent
-  All vents
-  Center vents
-  Center and footwell vents

THERMOTRONIC

-  Defroster vent
-  Defroster and center air vent
-  All vents
-  Defroster and footwell vents
-  Center vents
-  Center and footwell vents
-  Footwell vents

### Setting the air distribution

#### Requirements:







- The climate control system is switched on.
- Press the  button repeatedly until the desired air distribution appears in the air conditioning system display.

### Defrosting the windows







#### Windows fogged up on the inside Vehicles with heating system

- Press the  button.  
When windshield defrosting is switched on, the temperature and airflow cannot be adjusted.
- Close the front air vents (→ page 91).

#### Vehicles with TEMPMATIC or THERMOTRONIC

- Press the  button and, if necessary, use the  button to direct air onto the windshield .
- Increase the airflow as necessary and close the front air vents (→ page 91).
- If the windows remain fogged up: press the  button.  
When windshield defrosting is switched on, the temperature and airflow cannot be adjusted.  
 will appear on the climate control system display.
- Vehicles with a windshield heater:** press the  button.

Depending on operation, you can achieve faster defrosting and drying of the windshield with the following settings:

- Use the  button to direct air onto the windshield .
- Set the temperature  and the airflow  to maximum using the rocker switches.
- Close the front air vents (→ page 91).
- Vehicles with windshield heater: switch on the  windshield heater (→ page 91).
- For vehicles with heating systems: set the air distribution so that the  and  LEDs are off (→ page 86).

#### Windows fogged up on the outside

- Switch on the windshield wiper (→ page 81).

### Switching air-recirculation mode on/off

- Press the  button.  
The interior air will be recirculated.

Air-recirculation mode will switch off automatically.

-  When air-recirculation mode is switched on, the windows may fog up more quickly. Switch on air-recirculation mode only briefly.

Air-recirculation mode will automatically switch on in the following cases:

- in high outside temperatures
- while the vehicle is driving through a tunnel (vehicles with THERMOTRONIC automatic climate control and navigation only)
- when the wiping with washer fluid function is switched on (→ page 81)

The indicator lamp on the  button will not light up in this case. After a maximum of 30 minutes, outside air will automatically be introduced again.

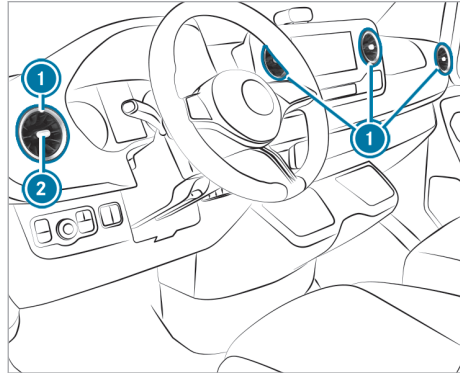

### Switching the windshield heater on and off

- i** In the event of high outside temperatures, the windshield heater may not switch on.
  - ▶ Press the  button. If the indicator lamp on the button lights up, the windshield heater has switched on.
- i** The windshield heater switches off automatically after a few minutes.
- i** If the battery voltage is too low, it may not be possible to switch the windshield heater on. If the battery voltage becomes too low while the windshield heater is in operation, the windshield heater will switch off automatically.

- ▶ **To open or close:** hold center **2** of air vent **1** and turn it to the left or right as far as it will go.
- ▶ **To set the airflow direction:** hold center **2** of air vent **1** and move it up or down or to the left or right.

### Switching the rear window heater on or off

- ▶ Press the  button. If the indicator lamp lights up, the rear window heater is switched on.

### Operating cargo compartment ventilation

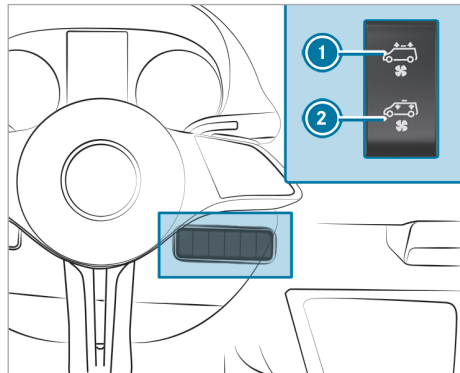

### Operating air vents

#### Adjusting the front-compartment air vents

**⚠ WARNING** Risk of burns or frostbite due to being too close to the air vents

Very hot or very cold air can flow from the air vents.

- ▶ Make sure that all vehicle occupants always maintain a sufficient distance from the air vents.
- ▶ If necessary, direct the airflow to another area of the vehicle interior.

If your vehicle is equipped with a roof ventilator, you can admit fresh air to the cargo compartment, and extract air from it as well.

- ▶ Switch on the vehicle.
- ▶ **To switch on and extract:** press the top section of switch **1**. The roof ventilator will remove used air from the cargo compartment.
- ▶ **To switch on and admit fresh air:** press the bottom section of switch **2**. The roof ventilator will feed fresh air into the cargo compartment.
- ▶ **To switch off:** place the switch in the center position.

## Pre-entry climate control

### Notes on pre-entry climate control

**⚠ WARNING** Risk of fatal injury due to exposure to extreme heat or cold in the vehicle

If persons, particularly children, are subjected to prolonged exposure to intense heat or cold, there is a risk of severe injury or even death.

- ▶ Never leave persons, particularly children, unattended in the vehicle.

**⚠ WARNING** Risk of burns due to repeatedly switching on the seat heating

Repeatedly switching on the seat heating can cause the seat cushion and seat backrest padding to become very hot.

In particular, the health of persons with limited temperature sensitivity or a limited ability to react to high temperatures may be affected or they may even suffer burn-like injuries.

- ▶ Do not repeatedly switch on the seat heating.

To protect against overheating, the seat heating may be temporarily deactivated after it is switched on repeatedly.

Depending on the vehicle equipment, the following functions can be activated as needed during pre-entry climate control:

- Automatic climate control
- Blower
- Seat heating
- Steering wheel heater
- Mirror heater
- Rear window defroster
- Windshield heater

### Setting pre-entry climate control when the vehicle is unlocked

Multimedia system:

→  **eSprinter**  
 ▶▶ Pre-entry Climate Control ▶▶ Settings

With this function, the seats can be briefly pre-warmed or pre-cooled before you get into the vehicle.

- ▶ Activate or deactivate the function.

### Selecting seats

- ▶ Use the **Driver's Seat Only** setting to specify whether only the driver's seat or also the front passenger seat is air-conditioned. The seat-specific functions of pre-entry climate control, such as seat heating, will be performed for the selected seats.

If pre-entry climate control is enabled, an LED on the climate bar of the air-conditioning control panel of the central display will light up blue for a cooled vehicle and red for a heated vehicle.

### Activating/deactivating pre-entry climate control when the vehicle is unlocked

Requirements:

- The high-voltage battery is charged sufficiently.
- The function is activated in the multimedia system.

- ▶ **To activate:** unlock the vehicle.

The climate control functions will be activated for up to five minutes for pre-heating and pre-cooling.

- ▶ **To switch off:**

- Press the  button on the air-conditioning control panel.
- Locking by key (if the vehicle is parked for fewer than 15 minutes)

- ⓘ Pre-entry climate control will not be terminated via the automatic locking mechanism.
- ⓘ Seat heating will also remain switched on after the vehicle has been started.

### Setting pre-entry climate control at departure time

Multimedia system:

→  **eSprinter**  
 ▶▶ Pre-entry Climate Control ▶▶ Settings

### Setting the departure time

The air inside the vehicle can be heated, ventilated or cooled to the set temperature when the vehicle is parked.

When the vehicle is connected to power supply equipment, priority will be given to charging the high-voltage battery to a specified minimum state of charge.

With active pre-entry climate control, the state of charge of the high-voltage battery may be reduced, even if the charging cable connector is inserted.



The set temperature can be changed up to one minute after the start of pre-entry climate control.

- ❗ At low charge levels of the high-voltage battery, it may not be possible to reach the desired interior temperature.
- ❗ The set departure times are used for the vehicle's pre-entry climate control system and to predict the state of charge at the time selected. Additional information on the charging settings (→ page 108).
- ❗ If Range Assistant is activated, an approximate time for reaching the desired state of charge will be determined automatically during a charging stop. This is used as an approximate departure time for pre-entry climate control and is set automatically. Previously set departure times cannot be changed when the function is active. The automatically determined departure time can be activated or deactivated via the eSprinter menu.

▶ **To select a seat:** use the **Driver's Seat Only** setting to specify whether only the driver's seat or also the front passenger seat is air-conditioned. Pre-entry climate control will take place for the selected seats.

If a departure time is set, a yellow LED will appear on the air-conditioning control panel. In addition, an LED on the air-conditioning control panel will indicate when pre-entry climate control is activated. It will light up blue when the vehicle is being cooled and red when it is being heated

### Activating/deactivating pre-entry climate control at departure time

Requirements:

- The high-voltage battery is charged sufficiently.
- The vehicle is switched off.
- The windows are closed.
- The doors to the passenger compartment are closed.
- The date and time are set correctly.

▶ **To activate:** set the departure time (→ page 108). Pre-entry climate control at departure time will switch on a maximum of 60 minutes before the selected departure time. If the departure is delayed, the pre-entry climate control will be active for another ten minutes.

▶ **To deactivate the pre-entry climate control at departure time early:** press the  button

on the air-conditioning control panel or switch off the preselection of the time in the **eSprinter** menu.

- ❗ Seat heating will also remain switched on after the vehicle has been started.

### Operating immediate pre-entry climate control via the air conditioning control panel

#### Requirements

- The vehicle must be switched off.
- The high-voltage battery is charged sufficiently.

Air conditioning of the vehicle interior can continue for up to 30 minutes, e.g. if the journey is interrupted.

- ▶ Press the  button on the air conditioning control panel.
- ▶ Set the temperature on the air conditioning control panel.

An LED will indicate when pre-entry climate control is activated. It will light up blue when the vehicle is being cooled and red when it is being heated.

## Driving

### Notes on electric mode

**⚠ DANGER** Risk of fire and explosion from excessive internal pressure of the high-voltage battery

In the event of a vehicle fire, flammable gas can escape and ignite.

- ▶ If there is an unusual smell, smoke or burn marks, stop the charging process immediately.
- ▶ Leave the danger zone immediately. Secure the danger area at a sufficient distance.
- ▶ Call the fire service.

**⚠ WARNING** Risk of chemical burns and poisoning from damaged high-voltage battery

If the housing of the high-voltage battery has been damaged, electrolyte and gases may leak out.

- ▶ Avoid contact with the skin, eyes or clothing.
- ▶ Immediately rinse electrolyte splashes off with water and seek medical attention straight away.

Observe the following notes on vehicle noise emissions and the acoustic vehicle alerting system:

- The vehicle is equipped with a purely electric drive system and develops considerably lower vehicle noise emissions than vehicles with a combustion engine.  
This is why the vehicle is equipped with a sound generator, which serves as an acoustic vehicle alerting system (AVAS). This safety system is prescribed by law.  
The external noise of the sound generator is perceptible in the vehicle interior at low speeds and does not represent a malfunction.
- The sound generator generates speed-dependent vehicle noise emissions when the vehicle is driving forwards or backing up at a speed of up to around 20 mph (30 km/h).  
This helps other road users – especially pedestrians and cyclists – to hear your vehicle better.
- From a speed of 12 mph (20 km/h), the acoustic vehicle alerting system gradually switches off.

- Despite the sound generator, the vehicle still may not be heard by other road users. Adapt your driving style accordingly.
- The sound generator is off when the vehicle is stationary.

### Manually disconnecting the high-voltage on-board electrical system

**⚠ DANGER** Risk of death and fire due to modified and/or damaged components of the high-voltage on-board electrical system

The vehicle's high-voltage on-board electrical system is under high voltage. If you modify component parts in the vehicle's high-voltage on-board electrical system or touch damaged component parts, you may be electrocuted. In addition, modified and/or damaged components may cause a fire.

In the event of an accident or impact to the underbody, components of the high-voltage electrical system may be damaged although the damage is not visible.

- ▶ Never make any modifications to the high-voltage on-board electrical system.
- ▶ Do not switch on or use the vehicle if its high-voltage on-board electrical system components have been modified or damaged.
- ▶ Never touch damaged components of the high-voltage on-board electrical system.
- ▶ After an accident, do not touch any components of the high-voltage on-board electrical system.
- ▶ After an accident, have the vehicle transported away.
- ▶ Have the components of the high-voltage on-board electrical system checked at a qualified specialist workshop and replaced if necessary.

#### Requirements:

- The  restraint system warning lamp lights up in the instrument cluster, e.g. after an accident.
- The vehicle is badly damaged, e.g. after an accident, and the restraint system components have not been triggered.
- The vehicle has not been started.
- The vehicle is secured against rolling away.

### Using the high-voltage disconnect device in the engine compartment

Disconnect the drive system manually only under the prerequisites in the specified situations.

- ▶ Open the hood (→ page 171).

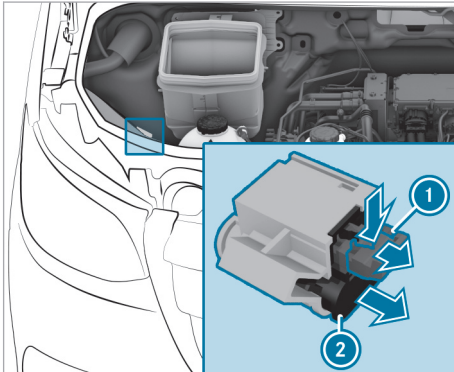

- ▶ Press release tab ① in the direction of the arrow and pull it out.
- ▶ Pull high-voltage disconnect device ② in the direction of the arrow until it engages. The drive system has been disconnected. The capacitors of the vehicle's high-voltage electrical system are completely discharged after one minute at the earliest.

All work on the drive system may be carried out only at a qualified specialist workshop, even if it has been deactivated manually.

### Using the high-voltage rescue separation point in the seat base of the driver's seat

Disconnect the drive system manually only under the prerequisites specified in the above-mentioned situations.

The high-voltage rescue separation point should be used only in an emergency and only by rescue personnel. The high-voltage rescue separation point is located in the seat base of the driver's seat.

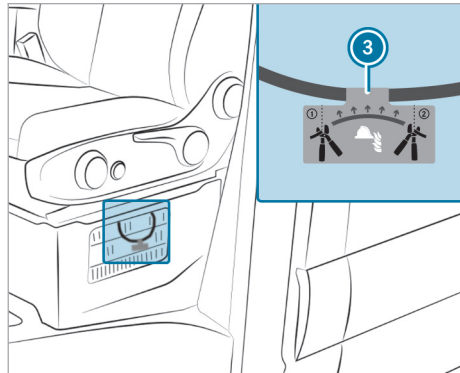

- ▶ Open the fuse box in the seat base of the driver's seat (→ page 187).
- ▶ Sever the orange cable at marked position ③ with a suitable tool. The drive system has been disconnected. The capacitors of the vehicle's high-voltage electrical system are completely discharged after one minute at the earliest.

All work on the drive system may be carried out only at a qualified specialist workshop, even if it has been deactivated manually.

## Regenerative brake system

### Function of the regenerative brake system

To charge the high-voltage battery while driving, the electric motor is operated as a alternator, depending on the selected recuperation level, in overrun mode and during braking. As soon as you release the accelerator pedal when the vehicle is in motion, recuperation in overrun mode is initiated. This does not apply if you have selected the recuperation level **D** **+** **+** (no recuperation).

The regenerative brake system has the following characteristics:

- it supports braking with electronically controlled brake force boosting
- it converts the kinetic energy of the vehicle into electric energy

You can use the steering wheel paddle shifters to manually adjust the intensity of recuperation in overrun mode (→ page 96).

### System limits

The braking effect of the electric motor during recuperation in overrun mode may be reduced or may not be available at all in the following situations:

- with increasing state of charge of the high-voltage battery
- if the high-voltage battery has not yet reached operating temperature
- when driving at very slow speeds (near standstill)
- in drive range **N**
- during and after ESP<sup>®</sup> intervenes

### Manually setting recuperative deceleration

You can use the steering wheel paddle shifters to manually adjust the intensity of recuperation in overrun mode.

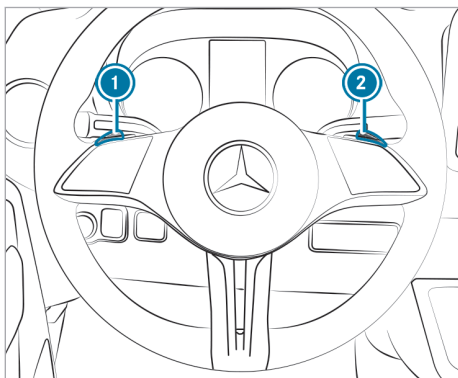

The higher the recuperation, the more sharply the vehicle is braked when coasting and the more electric energy is fed into the high-voltage battery.

**i** Recuperation level **D** is automatically set after restarting the vehicle.

- ▶ **To increase recuperation:** briefly pull steering wheel paddle shifter **1**.
- ▶ **To decrease recuperation:** briefly pull steering wheel paddle shifter **2**.
- ▶ **D AUTO To select:** pull and hold steering wheel paddle shifter **1** or **2**.

The following recuperation levels are available:

- **D AUTO** Radar-supported recuperation taking road and traffic conditions into account, or

intelligent and anticipatory recuperation with ECO Assist

- **D + +** No recuperation: the vehicle coasts, rolls freely, e.g. for driving on highways
- **D +** Decreased recuperation: slight deceleration in overrun mode
- **D** Normal recuperation
- **D -** Increased recuperation: maximum deceleration in overrun mode, e.g. for driving in the city

The display in the instrument cluster shows the recuperation level currently set in the display of the transmission position, e.g. **D -**.

**i** In addition to radar detection, ECO Assist analyze other data for the expected route. This allows ECO Assist to help optimally adjust the driving style for the route ahead, use minimal energy and recuperate.

### Switching on the power supply or drive system using the start/stop button

**⚠ WARNING** Risk of accident and injury due to children left unattended in the vehicle

If you leave children unattended in the vehicle, they could, in particular:

- open doors, thereby endangering other persons or road users.
- get out and be struck by oncoming traffic.
- operate vehicle equipment and become trapped, for example.

In addition, the children could also set the vehicle in motion by, for example:

- releasing the parking brake.
- changing the gearbox position.
- starting the vehicle.

- ▶ Never leave children unattended in the vehicle.
- ▶ When leaving the vehicle, always take the key with you and lock the vehicle.
- ▶ Keep the key out of reach of children.

### Requirements:

- the key is in the detection range of the antenna (→ page 39) and the key battery is not flat
- the brake pedal is not depressed

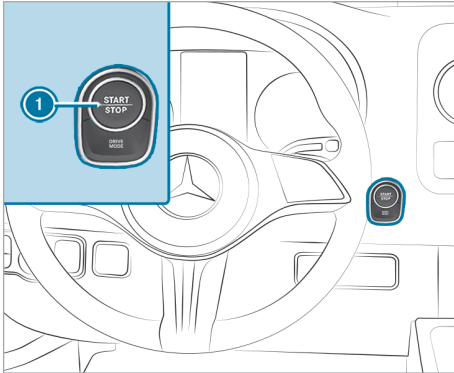

- ▶ **To switch on the power supply:** press button ① once.  
You can, for example, activate the windshield wipers.

The power supply will be switched off again when one of the following conditions is met:

- you open the driver's door
- you press button ① twice more

- ▶ **To switch on the drive system:** press button ① twice.  
The indicator lamps on the instrument cluster will light up.

The drive system will be switched off again if one of the following conditions is met:

- You do not start the vehicle within 15 minutes.
- You press button ① once.

## Starting the engine

### Starting the vehicle with the start/stop button

#### Requirements:

- the key is in detection range of the antenna (→ page 39) and the key battery is not discharged.

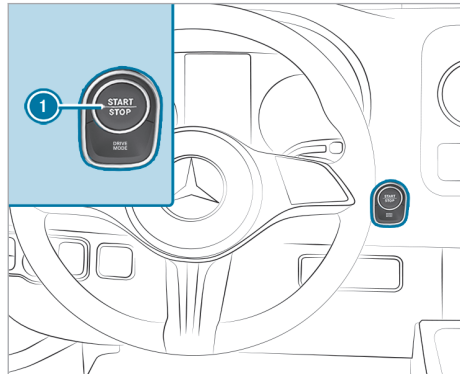

- ▶ Shift the transmission to position **P** or **N**.
- ▶ Depress the brake pedal and press button ① once.  
The vehicle will start. Once the vehicle can be driven, the **READY** display will appear on the instrument cluster.
- ▶ If the vehicle does not start: switch off any unnecessary consumers and press button ① once.
- ▶ If the vehicle still does not start and the display message **Place Key in Marked Space See Operator's Manual** appears in the instrument cluster: start the vehicle in emergency operation mode.
- ⓘ If you leave the driver's seat after starting the vehicle, the instrument cluster will show a display message reading **Vehicle Operational Switch the Ignition Off Before Exiting**. If you do not sit in the driver's seat within the next minute, the vehicle will automatically switch off.

### Starting the vehicle in emergency operation mode

If the vehicle does not start and the display message **Place Key in Marked Space See Operator's Manual** appears on the instrument cluster, you can start the vehicle in emergency operation mode

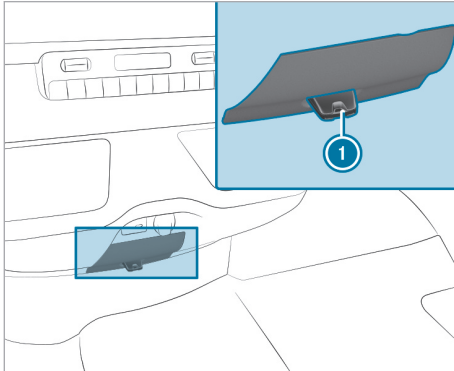

- ▶ Remove key ❶ from your key ring.
- ▶ Insert key ❶ into the slot.  
The vehicle is started after a brief time.
- ▶ Leave the key inserted during the entire journey.

❶ When you remove key ❶ from the slot, the vehicle stays switched on.

- ▶ Have key ❶ checked at a qualified specialist workshop.

#### If the vehicle does not start:

- ▶ Leave key ❶ in the slot.
- ▶ Depress the brake pedal.
- ▶ Start the vehicle with the start/stop button.

❶ You can also switch on the power supply or the drive system with the start/stop button.

#### Breaking-in notes

After the vehicle has been delivered or after repairs, the sensor system of some driving systems and driving safety systems will adjust itself automatically after the vehicle has been driven a certain distance. Full system effectiveness will not be reached until the end of this teach-in process.

New or replaced brake pads, brake discs and tires will provide optimal braking and grip only after several hundred kilometers. Until then, compensate for the reduced braking effect by depressing the brake pedal with greater force.

#### Driving tips

##### Notes on driving

**⚠ WARNING** Risk of accident due to objects in the driver's footwell

Objects in the driver's footwell may impede pedal travel or block a depressed pedal.

This will jeopardize the operating and road safety of the vehicle.

- ▶ Stow all objects in the vehicle securely so that they cannot get into the driver's footwell.
- ▶ Make sure that there is always sufficient clearance for the pedals.
- ▶ Ensure there are non-slip attachments for floor mats and carpets.
- ▶ Do not lay multiple floor mats or carpets on top of one another.

**⚠ WARNING** Risk of accident due to incorrect footwear

Incorrect footwear includes, for example:

- Shoes with platform soles
- Shoes with high heels
- Slippers

There is a risk of an accident.

- ▶ Always wear suitable footwear so that you can operate the pedals safely.

**⚠ WARNING** Risk of accident if the vehicle is switched off while driving

If you switch off the vehicle while driving, safety functions are restricted or no longer available.

This may affect the power steering system and the brake force boosting, for example.

You will need to use considerably more force to steer and brake, for example.

- ▶ Do not switch off the vehicle while driving.

**⚠ WARNING** Risk of skidding and accident if recuperation level is increased on a slippery road surface

If the recuperation level is increased on a slippery road surface, the drive wheels may lose grip.

- ▶ Do not increase the recuperation level on a slippery road surface.

**⚠ WARNING** Risk of accident and injury due to being under the influence of alcohol and drugs while driving

Drinking and driving and/or taking drugs and driving are very dangerous combinations. Even a small amount of alcohol or drugs can affect your reflexes, perceptions and judgment.

The possibility of a serious or even fatal accident are greatly increased when you drink or take drugs and drive.

- ▶ Do not drink or take drugs and drive or allow anyone to drive who has been drinking or taking drugs.

**⚠ WARNING** Risk of accident and injury from operating mobile communications equipment

If you operate mobile communication equipment when driving, you will be distracted from the traffic situation. This could also cause you to lose control of the vehicle.

The probability of a serious or even fatal accident increases greatly if you operate mobile communication equipment when driving.

- ▶ Only operate mobile communication equipment when the vehicle is stationary.

For your own safety, observe the following points when operating mobile communications equipment:

- Please observe the legal requirements for the country in which you are driving.
- While driving, only operate mobile communications equipment when the traffic conditions permit it. You could otherwise be distracted from traffic, cause an accident and injure yourself and others.

**!** **NOTE** Vehicle damage due to failure to observe the maximum permissible clearance height

If the vehicle height exceeds the maximum permissible clearance height, the roof and other vehicle parts may be damaged.

- ▶ Please observe the maximum clearance height indicated.

- ▶ If the vehicle exceeds the permissible clearance height, do not drive in.
- ▶ Take the modified vehicle height into account in the case of roof superstructures or other carrier systems.

- i** Please bear in mind that all the speeds indicated in this Operator's Manual are approximate and are subject to a certain tolerance.

### ■ Notes on speed limitation

**⚠ WARNING** Risk of injury through exceeding the specified tire load-bearing capacity or the permissible speed rating

Exceeding the specified tire load rating or the permissible speed rating may lead to tire damage and to the tires bursting.

- ▶ Therefore, only use tire types and sizes approved for your vehicle model.
- ▶ Observe the tire load rating and speed rating required for your vehicle.

Find out about the maximum permissible speed resulting from the tires, i.e. tires and tire pressure. Please observe the legal requirements for tires for the country you are in.

- i** **Vehicles with tachograph:** due to the different certification requirements for the tachograph and instrument cluster, the displayed speeds may differ. Please keep to the speed display on the instrument cluster.

You can permanently limit the speed of your vehicle.

Mercedes-Benz recommends a qualified specialist workshop for programming the speed limitation.

Note that you cannot exceed a programmed speed limitation when overtaking.

On downhill gradients, the speed limitation may be exceeded. Apply the brakes if necessary.

Display messages will warn you that you are approaching the speed limitation.

- i** For bus-equipped vehicles, the ex-works speed limitation for your vehicle is 60 mph (100 km/h) When overtaking, bear in mind that the speed limitation cannot be exceeded.

### ■ Information about transport by rail

Transporting your vehicle by rail may be subject to certain restrictions or require special measures to be taken in some countries due to varying tunnel heights and loading standards.

You can obtain information about this from any authorized Mercedes-Benz Center.

### Information on braking

#### Heavy and light loads

If the brakes have been subjected to heavy use, do not park the vehicle immediately. Drive on for a short while. The brakes cool down more quickly in the airflow.

If you only make moderate use of the brakes, you should occasionally test their effectiveness. To do this, brake more firmly from a higher speed while paying attention to the traffic conditions. The brakes will grip better as a result.

#### Wet road surfaces

If you have been driving for a long time in heavy rain without braking, there may be a delayed response when you first apply the brakes. This may also occur after driving through a car wash or deep water. You must depress the brake pedal more firmly. Maintain a greater distance from the vehicle in front.

While paying attention to the traffic conditions, you should brake the vehicle firmly after driving on a wet road surface or through a car wash. This heats the brake discs so that they dry more quickly, which protects them against corrosion.

Impaired braking effect on roads treated with deicing salt:

- a layer of salt on the brake discs or brake linings can increase braking distances considerably, or braking may only be one-sided
- maintain an especially large safety distance from the vehicle in front

To remove the layer of salt:

- apply the brakes from time to time, paying attention to traffic conditions
- depress the brake pedal gently at the end of a journey and when starting a new journey

#### Checking the brake lining thickness

In addition to monitoring by the brake lining wear sensor, you can regularly monitor and check all of the brake linings by a visual inspection for material wear.

If you are unable to check the brake lining wear on the inside of the wheels, remove the wheels if you possess the required skills. Otherwise visit a qualified specialist workshop.

If the brake lining material thickness is less than 0.12 in (3 mm), have the brake linings checked and

if necessary replaced at a qualified specialist workshop.

Do not rely solely on the brake lining wear sensor.

It is also strongly recommended that you have the brake linings checked at a qualified specialist workshop, and not only during every service prompted by the service interval display. Also check the brake linings before long journeys, and whenever the wheels are removed.

Check the brake linings in the following situations:

- during every service according to the service interval
- before long journeys
- every time a tire is replaced
- make regular visual inspections for your own safety

#### New brake discs and brake linings

New brake linings and brake discs only reach their optimal braking effect after a few hundred miles (a few hundred kilometres).

Until then, compensate for the reduced braking effect by pressing the brake pedal with greater force. For safety reasons, Mercedes-Benz recommends that you only have brake linings and brake discs which are approved by Mercedes-Benz installed in your vehicle.

Other brake discs or brake linings may compromise the safety of your vehicle.

Always replace all brake discs and brake linings on an axle at the same time. Always fit new brake linings when replacing brake discs.

### Information about driving on wet roads

#### Hydroplaning

**⚠ WARNING** Risk of hydroplaning due to insufficient tire tread

Depending on the level of water on the road surface, hydroplaning may occur.

- ▶ Avoid tire ruts and brake carefully.
- ▶ Change tires that do not have sufficient tire tread.

Therefore, in heavy rain or other conditions in which hydroplaning can occur, drive as follows:

- reduce your speed.
- avoid tire ruts.
- brake carefully.



### Driving on flooded roads

Bear in mind that vehicles traveling in front or in the opposite direction create waves. This may cause the maximum permissible water depth to be exceeded. These notes must be observed under all circumstances. Otherwise, you could damage the drive system, electrics and transmission.

If you have to drive on stretches of road on which water has collected, please bear in mind the following:

- the level of standing water must not be above the lower edge of the front bumper
- you must drive no faster than walking pace.

### Information about driving in winter

Drive particularly carefully on slippery roads. Avoid sudden acceleration, steering and braking maneuvers.

Have your vehicle winterproofed at a qualified specialist workshop in good time at the onset of winter.

Please observe the notes on snow chains (→ page 191).

Regularly check the vehicle and remove snow or ice when traveling in wintry conditions.

An accumulation of snow and ice, particularly when frozen, in the area around the air intake, moving parts, the axles and the wheel wells may cause the following problems:

- obstruction of the air intake
- damage to vehicle parts
- Malfunctions due to restriction of the movement intended by the design (e.g. reduced steering movement)

If there is any damage, inform a qualified specialist workshop.

### Information about driving off road

**▲ WARNING** Risk of accident if you do not keep to line of fall on inclines

If you drive at an angle or turn on an incline, the vehicle could slip sideways, tip and rollover.

- ▶ Always drive on inclines in the line of fall (straight up or down) and do not turn.

**▲ WARNING** Risk of injury from acceleration forces during off-road driving

You could be thrown from your seat, for example.

- ▶ Always wear your seat belt even when driving off-road.

**▲ WARNING** Risk of injury to the hands when driving over obstacles

If you drive over obstacles or in tire ruts, the steering wheel may whip around.

- ▶ The steering wheel must always be held securely with both hands.
- ▶ Always hold the steering wheel so that your thumbs are on the outer rim of the steering wheel.
- ▶ When driving over obstacles, expect increased steering forces at short notice.

**■ NOTE** Damage to the vehicle after driving off-road

Foreign bodies, such as stones and branches, could become trapped on the vehicle underside or on wheels and tires while you are driving and cause damage to the vehicle.

Foreign bodies could cause the following damage:

- Damage to the suspension, the high-voltage battery on the vehicle underside or the brake system
- Cause imbalances and thus vibrations
- ▶ Regularly remove any trapped foreign bodies, e.g. stones and branches.
- ▶ After driving off-road, check carefully whether there is any damage to the vehicle.
- ▶ If there is damage, have the vehicle checked at a qualified specialist workshop.

When driving off road or on unpaved surfaces, check the vehicle underside, wheels and tires at regular intervals. In particular, remove any trapped foreign bodies, e.g. stones and branches.

Please observe the following notes regarding foreign bodies of this kind:

- They could damage the suspension, the high-voltage battery in the underbody or the brake system.
- They could cause imbalances and thus vibrations.
- They could be ejected from the vehicle when you continue driving.

If there is any damage, inform a qualified specialist workshop.

When you drive off road and on construction sites, sand, mud and water, for example, possibly mixed with oil, may get into the brakes. This may lead to a reduction in braking performance or total brake failure, including as a result of increased wear. The braking characteristics will vary depending on the material that has infiltrated the system. Clean the brakes after driving off road. If you then notice reduced braking performance or hear scraping noises, have the brake system checked immediately at a qualified specialist workshop. Adapt your driving style to the changed braking characteristics.

Driving off road or on construction sites increases the possibility of vehicle damage, which could in turn lead to the failure of certain major assemblies or systems. Adapt your driving style to the off-road driving conditions. Drive carefully. Have any vehicle damage repaired at a qualified specialist workshop as soon as possible.

When driving on rough terrain, do not shift the transmission to neutral. You could lose control when attempting to slow the vehicle with the service brake. If your vehicle cannot manage an uphill incline, drive back down in reverse gear.

When loading your vehicle for driving off road or on a construction site, keep the vehicle's center of gravity as low as possible.

#### Checklist before driving off road

- **Vehicle tool kit:** check that the jack is working (→ page 207).
- Make sure that a wheel wrench (→ page 207), a wooden underlay for the jack, a sturdy tow rope, a folding spade and a wheel chock (will be present, depending on equipment) are carried in the vehicle.
- **Tires and wheels:** check the tire tread depth (→ page 190) and the tire pressure (→ page 196).

#### Rules for off-road driving

Always be aware of the vehicle's ground clearance and avoid obstacles such as deep tire ruts.

Obstacles may damage the following parts of the vehicle, for example:

- Suspension
- Drivetrain
- The high-voltage battery in the underbody

Therefore, always drive slowly off road. If you must drive over obstacles, have the front passenger guide you.

- **i** Mercedes-Benz recommends that you additionally carry a shovel and a recovery rope with a shackle in the vehicle.
- Make sure that loads and items of luggage are securely stowed or lashed down (→ page 164).
- If the surface requires, temporarily deactivate ESP® when starting off (→ page 120).
- Drive slowly and smoothly. It may often be necessary to drive at walking pace.
- Avoid spinning the wheels.
- Ensure that the wheels remain in contact with the ground.
- As a precaution, get out of the vehicle to take a look at the route ahead. Exercise the utmost caution when driving across unfamiliar, unpredictable terrain.
- Look out for obstacles (e.g. rocks, holes, tree stumps and tire ruts).
- Avoid edges where the ground could crumble or break away.

#### Checklist after driving off road

Driving off road places greater demands on your vehicle than driving on normal roads. Check your vehicle after driving over rough terrain. By doing so, you will notice any damage in good time and reduce the risk of an accident for yourself and other road users. Clean your vehicle thoroughly before driving on public roads.

If you find damage to the vehicle after off-road driving, have the vehicle checked at a qualified specialist workshop immediately.

Please note the following points after driving off road or on construction sites and before driving on public roads:

- Activate ESP® (→ page 120).
- Clean the exterior lighting, particularly the headlamps and tail lamps, and check them for damage.
- Clean the front and rear license plates.
- Clean the windshield, windows and outside mirrors.
- Clean the steps, entrances and grab handles. This will make your footing safer.
- Clean the wheels and tires, wheel wells and the underbody of the vehicle with a jet of

water. This will increase traction, especially on wet road surfaces.

- Check the wheels and tires and wheel wells for trapped foreign objects and remove them. Trapped foreign objects can damage the wheels and tires or could be ejected from the vehicle when you continue the journey.
- Check the underbody for trapped branches or other vegetation and remove them.
- Clean the brake disks, brake pads and axle joints, particularly after operation in sand, mud, grit and gravel, water or similarly dirty conditions.
- Check the entire floor assembly, the tires, wheels, bodywork structure, brakes, steering and suspension for damage.
- Check the service brake for operating safety, e.g. carry out a brake test.
- If you notice significant vibrations after driving off road, check the wheels and drivetrain for foreign objects again. Remove any foreign objects that could lead to imbalances and thus cause vibrations. In the event of damage to the wheels and the drivetrain, visit a qualified specialist workshop immediately.

### Overview of the energy flow display in the multimedia system

The active components of the drive system are highlighted in the energy flow display. The energy flow between the individual components is shown in color.

The components displayed are:

- State of charge of the high-voltage battery
- Electric motors (drive system)
- Energy flow
- High-voltage battery

The energy flow will be shown in different colors depending on the operating status:

- **White:** heavy acceleration (boost effect)
- **Copper:** driving at constant speed or with moderate acceleration
- **Blue:** recuperation (charging the high-voltage battery) or overrun mode

### Showing the energy flow display

Multimedia system:



Select **Energy Flow**.

The energy flow in the vehicle will be displayed.

### Function of the ECO display

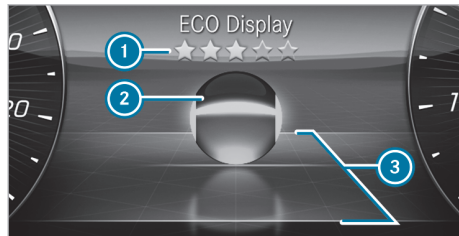

The ECO display shows an evaluation of your driving style on the driver display depending on the situation. This enables you to check the efficiency of your driving style and adjust it if necessary. The **ECO Display** menu shows a ball (2) that will roll forwards or backwards in the direction of travel on a stylized road according to the driving characteristics.

Above and below the road, lines mark the area for an efficient driving style (3). Ball (2) will light up in green if it is rolling within these lines. Outside the lines, the ball will light up in orange.

The ECO display assesses the following criteria for an economical driving style:

- Coasting at the right times
- Consistent speed
- Moderate acceleration

The overall assessment of your driving style "from start" is indicated using stars (1). It starts with five empty stars, which you can fill one after the other if you drive efficiently. When all five stars are filled, a glow will appear in the background.

**i** You can call up the **ECO Display** function via the **Trip** menu.

## Drive programs

### Function of the program selector button

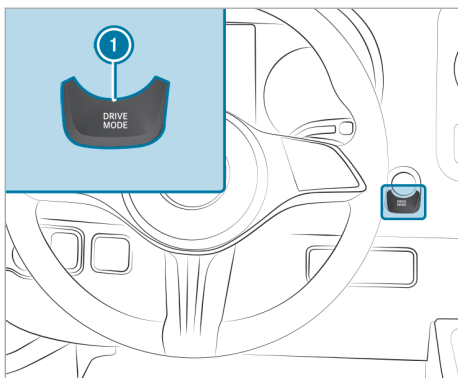

Use program selector button  to switch between the following drive programs:



-  (Comfort)
-  (Eco)
-  (MAX Range)



Depending on the drive program selected, the following vehicle characteristics will change:

- The performance of heating or air conditioning
- Output of the drive system
- Acceleration

The available power of the drive system is shown on the instrument cluster display and can be reduced, e. g. when the high-voltage battery has a very low state of charge (→ page 140).



### Characteristics per drive program:

Drive program	Vehicle characteristics
 (Comfort)	<ul style="list-style-type: none"> <li>• Comfortable driving style</li> <li>• Full heating and air-conditioning output</li> <li>• Maximum power availability of the drive system</li> </ul>
 (Eco)	<ul style="list-style-type: none"> <li>• Efficient and economical driving style</li> <li>• Reduced heating and air conditioning output for increased range</li> <li>• Reduced power of the drive system</li> </ul>
 (MAX Range)	<ul style="list-style-type: none"> <li>• Maximum range and consumption optimization</li> <li>• Heavily reduced heating and air-conditioning output</li> <li>• Reduced torque and severely reduced drive system output</li> </ul>

-  If you depress the accelerator pedal beyond the point of resistance (kickdown), the maximum power will also be available in drive programs  and .

### Selecting a drive program

- ▶ Press the program selector button. The drive program selected will appear on the instrument cluster display next to the transmission position display.

Depending on the selected energy content of the high-voltage battery, the  or  drive program will be automatically selected after a drive system start.

## Transmission

### DIRECT SELECT lever

#### Function of the DIRECT SELECT lever

 **WARNING** Risk of accident and injury if children are left unattended in the vehicle

If children are left unattended in the vehicle, they could in particular:

- open doors, thereby endangering other persons or road users.
- get out and be struck by oncoming traffic.
- operate vehicle equipment and become trapped, for example.

In addition, the children could also set the vehicle in motion, for example by:

- releasing the parking brake.
  - changing gear.
  - starting the vehicle.
- ▶ Never leave children unattended in the vehicle.
  - ▶ When leaving the vehicle, always take the SmartKey with you and lock the vehicle.
  - ▶ Keep the SmartKey out of the reach of children.

You use the DIRECT SELECT lever to switch the drive range. The current drive range will appear on the display on the instrument cluster.

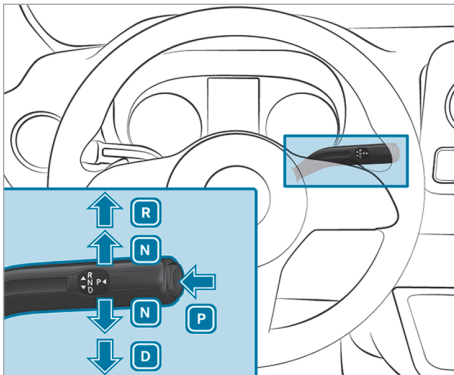

- P** Park position
- R** Reverse gear
- N** Neutral
- D** Drive position

### Engaging reverse gear R

- ▶ Depress the brake pedal and push the DIRECT SELECT lever upwards past the first point of resistance. Transmission position display **R** will be shown on the instrument cluster display.

### Selecting neutral N

**⚠ WARNING** Risk of accident and injury when neutral position is engaged

If you park the vehicle with the transmission in neutral position **N** and the parking brake is not engaged, the vehicle may roll away.

There is a risk of accident and injury.

- ▶ Before parking the vehicle, apply the parking brake.

- ▶ Press the brake pedal and the DIRECT SELECT lever upwards or downwards to the first point of resistance. Transmission position display **N** will be shown on the instrument cluster display.

Subsequently releasing the brake pedal will allow you to move the vehicle freely, e.g. to push it or tow it away.

**If the transmission is also to stay in neutral **N** when the vehicle is switched off, proceed as follows:**

- ▶ Start the vehicle.
- ▶ Depress the brake pedal and engage neutral **N**.
- ▶ Release the brake pedal.
- ▶ Switch off the vehicle.
- ⓘ If you then exit the vehicle leaving the key in the vehicle, the transmission will remain in neutral **N**.

### Engaging park position P

**!** **NOTE** Damage due to engaging park position **P** while the vehicle is rolling

If you shift the transmission into park position **P** while the vehicle is rolling, the transmission may be damaged.

- ▶ If the vehicle is rolling, do not open a door.
- ▶ Only engage park position **P** when the vehicle is stationary.

- ▶ Observe the notes on parking the vehicle (→ page 115).
- ▶ Depress the brake pedal until the vehicle is stationary.
- ▶ When the vehicle is stationary, press button **P**. When the transmission position **P** is shown, park position is engaged. If the transmission position **P** is not shown, apply the parking brake. Secure the vehicle against rolling away with a wheel chock or a non-sharp-edged object.

- i** Depending on the situation, it may take a short time until transmission position **P** is engaged. Therefore, always pay attention to the transmission position display.

Park position **P** will be engaged automatically when one of the following conditions is met:

- You switch the stationary vehicle off in transmission position **D** or **R**.
- You open the fully closed driver's door when the vehicle is stationary in transmission position **D** or **R**.
- When the vehicle is rolling, you switch it off in transmission position **D** or **R** and bring it to a standstill.
- When the HOLD function is active or the Active Distance Assist DISTRONIC system is active (vehicle stationary), the driver leaves the seat or the driver's seat belt buckle is unfastened.
- When the vehicle is rolling, you shift to transmission position **N**, bring the vehicle to a standstill and open the fully closed driver's door when the vehicle is stationary.
- Engaging park position **P** automatically is required by the vehicle.

- i** To maneuver with an open driver's door, open the fully closed driver's door while the vehicle is stationary and engage transmission position **D** or **R** again.

### Engaging drive position D

- ▶ Depress the brake pedal and push the DIRECT SELECT lever downwards past the first point of resistance.  
Transmission position display **D** will be shown on the instrument cluster display.

## Charging the high-voltage battery

### Notes on charging the high-voltage battery

- !** **NOTE** High-voltage battery damage due to leaving the vehicle idle for lengthy periods of time

Lithium-ion batteries experience a natural self-discharge.

Exhaustive discharging can therefore occur if the vehicle is idle for several months. This can damage the high-voltage battery.

- ▶ To avoid damage, please observe the following recommendations when handling the high-voltage battery.

- !** **NOTE** Accelerated aging of the high-voltage battery may occur if the following recommendations are not observed.

As a result of its basic characteristics, the storage capacity of and the amount of energy available from the high-voltage battery decreases over the course of its life. Therefore, both the maximum electrical range that can be achieved by the vehicle and its maximum electrical output can be impaired.

The following factors can accelerate the aging of the high-voltage battery:

- Frequent rapid charging with direct current (mode 4)
- Leaving the vehicle non-operational for long periods at high ambient temperatures

- ▶ To avoid accelerated aging, please observe the following recommendations when handling the high-voltage battery.

- !** **NOTE** Damage to the vehicle socket or the charge port due to incorrect handling

Do not use excessive force (maximum 67.4 lbf (300 N)) to insert the charge port into the vehicle socket to the stop. You may otherwise damage the vehicle socket, the charge port or their contacts.

- ▶ If you feel there is increased resistance, pull the charge port out of the socket and reinsert it.

- !** **NOTE** Damage to the drive system when charging the high-voltage battery at extreme elevations

The drive system may be damaged if the high-voltage battery is charged at elevations greater than 13,123.36 ft (4,000 m) above sea level.

It may then no longer be possible to continue the journey.

- ▶ Avoid charging processes at extreme elevations.

Information on charging times can be found in the technical data (→ page 222).

Recommendations for handling the high-voltage battery:

- Only use direct current (mode 4) to quick-charge the high-voltage battery if necessary.
- Charge the high-voltage battery on average to a state of charge of 80%. Beyond a state of charge of 80%, the charging time is significantly increased.
- If leaving the vehicle non-operational for lengthy periods, park it with a high-voltage battery state of charge of between 30% and 50%. Do not keep the high-voltage battery continuously connected to power supply equipment.
- If leaving the vehicle non-operational for lengthy periods of time avoid, if possible, high ambient temperatures.
- Check the high-voltage battery's state of charge every six weeks (→ page 108).
- If the state of charge is below 20%, recharge the high-voltage battery.
- Do not disconnect the 12 V battery even if the vehicle is left non-operational for a lengthy period. Otherwise the condition of the vehicle's high-voltage battery will not be monitored.

You can contribute to reducing the vehicle's energy consumption in the following ways:

- an anticipatory driving style (→ page 103)
- reduced use of electrical consumers
- regular servicing of the vehicle

The charging time of the high-voltage battery may change over the course of its life.

You can charge the high-voltage battery with both alternating current (mode 2 or 3) and direct current (mode 4).

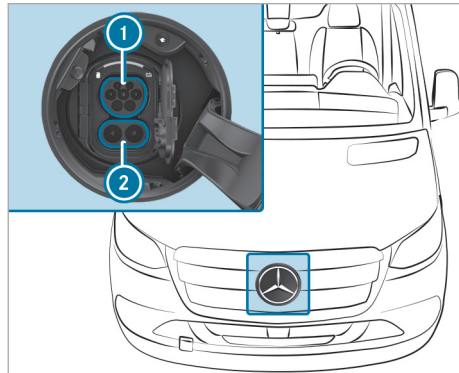

Vehicle socket in the radiator grille

- ① Socket for charging with alternating current
- ② Socket extension for charging with direct current
- i When using a CCS (Combined Charging System) charging cable to charge with direct current, both areas of the vehicle socket are covered by the charge port.

Charging options for the high-voltage battery:

- Charging through recuperation while the vehicle is in motion
- Stationary charging with alternating current via:
  - mains socket (mode 2)
  - wallbox (mode 3)
  - charging station (mode 3)
- Stationary charging with direct current via:
  - charging station (mode 4)

The charging current for single-phase charging is determined by the country-specific equipment installed in the vehicle.

Observe any possible different local mains requirements at your current location when charging. Consult a qualified electrician or your local distribution network operator if you have any questions concerning grid requirements.

It is recommended that you charge the high-voltage battery at a wallbox or charging station owing to the higher charging power and better charging efficiency offered.



### System limits

The charging time of the high-voltage battery may be increased by the following:

- high or low outside temperatures
- the vehicle remaining non-operational for an extended period without charge
- the maximum available charging current of the wallbox or power supply
- the settings for the charging process in the on-board computer
- you have consented to a calibration of the high-voltage battery (→ page 168)

The power output of the high-voltage battery may be impaired by the following:

- high or low outside temperatures
- electrical auxiliary consumers in the vehicle being switched on, e.g. operating the climate control system
- the vehicle remaining non-operational for an extended period without charge

### Function of the charge level display

- i** The data shown in the illustration are sample data.

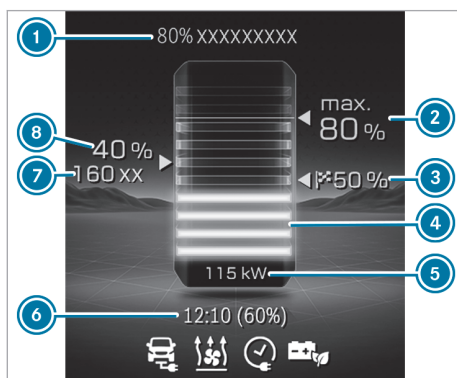

- 1 Time remaining until fully charged (until the selected maximum state of charge is reached)
- 2 Maximum state of charge (depending on the setting)
- 3 State of charge recommended by Range Assistant to reach the next destination
- 4 Dynamic charge level display
- 5 Current charging power

- 6 State of charge at next set departure time
- 7 Remaining range at current state of charge
- 8 Current state of charge of the high-voltage battery

- Set "Standard" charging program
- Pre-entry climate control active (automatic if departure time is set)
- Departure time symbol: one-time departure time set
- ECO charging activated

- i** Indicated remaining range **7** may vary due to different factors, e.g. driving style or topography.
- i** The value of the current charging power **5** can differ from the display on the charging station. At a charging power of 10 kW or higher, the value in the charge level display is rounded up or down and shown without a decimal place.

The value in **1** varies depending on the setting of the charging process. It displays a prediction for the time until the maximum state of charge is reached. If Range Assistant is active, it displays a prediction for the time until the continuation of the journey is recommended.

The value in **6** varies depending on the setting of the charging process. It displays the expected state of charge at the next set departure time. This may be a single event or the next element in the weekly profile.

In place of the symbol for the "Standard" charging program, the following symbols may also be displayed:

- The Home charging program is set.
- The Work charging program is set.

**i** An orange plug symbolizes a charging prompt. In addition to the symbol for the "One-time departure time" setting, the following symbols may also be displayed:

- No departure time is set.
- The weekly profile is active.

### Configuring the charging settings

Multimedia system:

For fleet vehicles, the eSprinter submenu or its menu items may not be available.



- ▶ Adjust the settings in the fleet management system, if possible.

### Setting the charging program

- ▶ Select **Home**, **Work** or **Standard**. The program set is shown as a symbol in the media display.

### Opening the socket flap in the MBUX multimedia system

- ▶ Press **Open Charge. Flap** to open the socket flap.
- ⓘ Additional notes on charging with alternating current: or direct current: .

### Setting the maximum state of charge

You can set the maximum state of charge in increments of 10% between 50% and 100%.

- ▶ Observe the notes on charging the high-voltage battery (→ page 106).
- ▶ Set the maximum state of charge to the desired value, for example 80%.
- ⓘ For the high-voltage battery used in this vehicle, we advise against continually limiting the maximum state of charge, but recommend charging the high-voltage battery fully at regular intervals.

### Unlocking the charging cable (mode 3 or 4)

- ⓘ When the function is active, the charging cable is unlocked once the maximum state of charge is reached.
- ▶ Select **Home** or **Work**.
- ▶ Activate or deactivate **Unlock Charging Cable**.

### Activating or deactivating location-based charging

- ▶ Select **Charging Program**, **Home** or **Charging Program**, **Work**.
- ▶ Activate or deactivate **Select Based on Location**.

When the function is activated, the vehicle's current position is saved as one of the selected options. When the address is reached again, the charging program is automatically switched over as soon as parking position **P** is engaged.

### Activating or deactivating ECO charging

- ▶ Activate or deactivate the function.

The **ECO Charging** function limits the charge current at charging stations in order to conserve the vehicle's battery. If the function is activated it is shown as a symbol in the media display.

### Setting the departure time

The set departure times are used for the vehicle's pre-entry climate control system and to predict the state of charge at the time selected.

The charging process always starts immediately, irrespective of the next departure time, as long as **ECO charging** is not active.

- ⓘ If the Range Assistant function is active, it automatically determines, during a charging stop, the approximate time at which the desired state of charge will be attained. This is used as an approximate departure time for pre-entry climate control and is set automatically. Previously set departure times cannot be changed when the function is active.

- ▶ Select **Departure Time**.

The following charging times can be set:

- individual charging times
- a **Week Profile**

### Setting an individual departure time

- ▶ Select **Add New Time** and set a new departure time.

or

- ▶ Select  and adjust an existing departure time.

### Setting the repeat days

- ▶ The weekly profile can only be set via "Mercedes me connect". Further information may be found in the "Mercedes me connect" Supplement.

### Functions of the indicator lamps on the vehicle socket

The charge socket flap with the Mercedes star in the radiator grill is centrally locked and unlocked together with the vehicle.

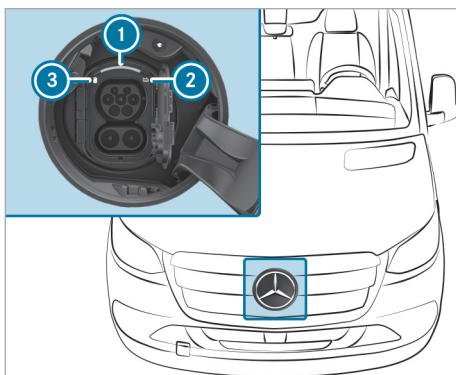

Vehicle socket in the radiator trim

- ① Status indicator
- ② Charging process indicator lamp
- ③ Locking status indicator lamp

Status display ① flashes or lights up as with indicator lamps ② and ③.

#### Overview of locking status

Locking status ③	Display	Meaning
	Lights up white	Vehicle socket unlocked, insert or remove charging cable
	Flashes white	Malfunction during locking or unlocking

#### Overview of the charging process status

Status of charging process ②	Display	Meaning
	Flashes orange	Connection is being established
	Flashes green	Active energy flow
	Lights up orange	Interruption in charging

Status of charging process ②	Display	Meaning
	Lights up green	Charging process completed
	Flashes red (for approx. 90 s)	Malfunction when charging

#### Notes on charging the high-voltage battery at the mains socket (mode 2)

**⚠ DANGER** Risk of fatal injury from incorrectly installed component parts

Connecting the charging cable to a mains socket using incorrectly installed component parts could cause a fire or an electric shock, for example.

- ▶ Only connect the charging cable to a mains socket that:
  - has been properly installed and
  - has been inspected by a qualified electrician
- ▶ For safety reasons, only use the charging cable supplied with the vehicle or an original Mercedes-Benz charging cable.
- ▶ Purchase these parts at an authorized Mercedes-Benz Center and obtain advice there.

Mercedes-Benz thoroughly tests these original charging cables for their suitability for high-voltage charging of your vehicle.

- ▶ Never use a damaged charging cable.
- ▶ Do not use:
  - extension cables
  - extension reels
  - multiple sockets
- ▶ Never use socket adapters to connect the charging cable to the mains socket. The only exception being if the adapter has been tested and approved by the manufacturer for charging the high-voltage battery of an electric vehicle.
- ▶ Observe the safety notes in the operating instructions for the socket adapter.

**!** **NOTE** Overloading the mains socket due to excessive charging current

If the charging current is too high, the fuse could be tripped or the external mains supply could overheat.

- ▶ Make sure that the external mains supply has been designed for the charging current on the vehicle side.
- ▶ Use a different, suitable mains socket.

Before charging at a mains outlet, have the maximum permissible charging current for the relevant mains outlet or the building inspected by a qualified electrician.

The charging cable can be set to a country-specific maximum charging current value. When charging abroad, the maximum value may exceed the permitted value for that country.

When abroad, observe the country-specific laws when charging.

Only charging cables that fulfill the local grid requirements of your location and are approved for your vehicle may be used.

If you have questions concerning charging cables or if there is a malfunction, please contact a qualified specialist workshop.

The charging process can vary depending on the power supply equipment.

Short charging times can be achieved:

- charging at a wallbox
- charging at a charging station

When doing so, always observe the local information.

### Notes on charging the high-voltage battery at a wallbox (mode 3)

**!** **DANGER** Risk of fatal injury from incorrectly installed component parts

Connecting the charging cable to a wallbox using incorrectly installed component parts could cause a fire or an electric shock, for example.

- ▶ Only connect the charging cable to a wallbox that:

- Has been properly installed and
- Has been inspected by a qualified electrician

- ▶ For safety reasons, only use charging cables that have been tested and approved by the manufacturer for charging the high-voltage battery in an electric vehicle.
- ▶ Never use damaged charging cables.
- ▶ Do not extend the charging cable.
- ▶ Do not use adapters.
- ▶ Observe the safety notes in the operating instructions for the wallbox.

Observe the local grid requirements of your current location when charging. When charging at a wallbox without a preinstalled cable, use only approved charging cables that conform to these grid requirements. Consult a qualified electrician or your local distribution grid operator if you have any questions concerning grid requirements.

### Notes on charging the high-voltage battery at a charging station (mode 3/4)

**!** **DANGER** Risk of fatal injury due to damaged components

Connecting the vehicle to a charging station using damaged component parts could cause a fire or an electric shock, for example.

- ▶ Perform a visual check of the charging station for obvious defects, for example damage to the housing or charging cable connection.
- ▶ Never use damaged charging cables.
- ▶ Do not use an extension for the charging cable.
- ▶ Do not use adapters.
- ▶ Always observe the safety instructions on the charging station.

**!** **DANGER** Risk of fatal injuries when carrying out maintenance work during the charging process

During the charging process, the high-voltage on-board electrical system is under high voltage.

- ▶ Do not perform any maintenance work during the charging process.

Observe the local network requirements at your current location when charging. When charging with alternating current at a charging station without a pre-installed cable, only use approved charging cables which conform to these network requirements. Consult a qualified electrician or your local distribution network operator if you have any questions concerning grid requirements.

Most charging stations need to be activated before the charging process, e.g. by using an RFID card or via Plug-and-Charge. Observe the on-site operator's instructions for the charging station and the notes on Mercedes me Charge (see the Digital Operator's Manual for the vehicle).

Due to legal regulations in the individual countries, the charging cable to the vehicle must be no longer than 98.5 ft (30 m). This is to prevent the interference of signals being received by radio communication devices in the vehicle or in close proximity to the charging station. Be aware that parts of the charging cable may be routed underground. If in doubt, ask the charging station operator if this is the case before charging the high-voltage battery.

### Starting the charging process

**⚠ DANGER** Risk of death when charging at a damaged socket

The charging process uses high voltage.

If the charging cable, the vehicle socket or the mains socket are damaged, you could receive an electric shock.

- ▶ Only use an undamaged charging cable.
- ▶ Avoid mechanical damage such as crushing, abrading or driving over the cable.
- ▶ Have a damaged vehicle socket replaced at a qualified specialist workshop as soon as possible.
- ▶ Never connect the charging cable to a damaged vehicle socket.

**! NOTE** Damage to the vehicle due to overvoltage in the mains supply

The vehicle is equipped with an electrical fuse which protects it against overvoltage in the mains supply. This electrical fuse may trip during severe thunderstorms, for example, and may cause the fuse in the building to trip or may interrupt the charging process. These functions protect the vehicle.

After the fuse in the building is switched on again, the charging process resumes automatically.

Following an interruption in the power supply without the fuse in the building being tripped, it may take up to ten minutes for charging to resume automatically.

**! NOTE** Damage due to overheating of charging cable and charge port

Charging cable and charge port may generate heat within the permissible limiting values during the charging process.

The heat generated by the charging cable and charge port is influenced by the following factors:

- The power supply of the mains and the charging cable are intact.
- The notes on handling the charging cable and operating unit on the charging cable were observed.

▶ If the charging cable or the charge port generate too much heat, have the power supply of the mains supply checked.

**! NOTE** Damaged or dirty vehicle socket when the socket flap is open

▶ Always keep the socket cover and the socket flap closed when there is no charging cable connected. This protects the vehicle socket from dirt and damage.

▶ Make sure that the socket cover is closed properly before closing the socket flap. This can otherwise result in damage which may prevent the socket flap from being opened again.

### Requirements

- The transmission is in position **P**.
- The drive system has not been started.
- The vehicle is unlocked, or the distance of the key to the vehicle socket is no greater than 3 ft (1 m). In addition, the battery of the key must be sufficiently charged.
- The hood is closed (only applies to mode 4).
- The charging cable is not under tension.

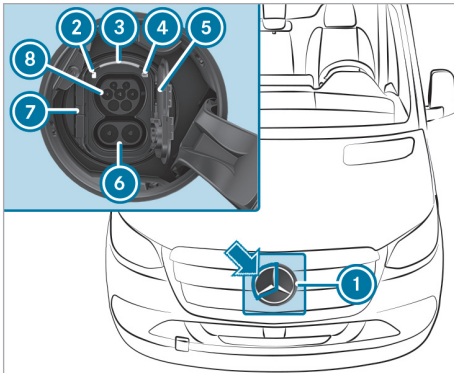

#### Vehicle socket in the radiator shell

- ▶ Press the top left of the socket flap ① for up to 1 second until it opens. The socket flap ① opens slightly. If the vehicle is not unlocked, the socket flap opens after a brief delay. The indicator lamp ②  and status display ③ light up white.
- ▶ Open socket flap ① completely.
- ⓘ If the drive system has been started (the **READY** display lights up in the instrument cluster), the socket flap ① cannot be opened.
- ▶ To charge with alternating current, press the upper catch, and to charge with direct current, press both catches ⑦ to the left. The respective socket cover ⑤ is opened.
- ⓘ For the charging process with alternating current (mode 2 or 3), only connection ⑧ is required.

#### Charging via mains socket (mode 2):

- ▶ Insert the mains plug into the mains socket of the external power source as far as it will go.
- ▶ Insert the charge port into connection ⑧ of the vehicle socket as far as it will go. Connection ⑥ remains free and should remain covered by the lower part of socket cover ⑤. The indicator lamp ④  and status display ③ initially flash orange, and then green as soon as the high-voltage battery is charged.

#### Charging at a wallbox or charging station (mode 3)

- ▶ Insert the charge port into connection ⑧ of the vehicle socket as far as it will go. Connection ⑥ remains free and should remain covered by the lower part of socket cover ⑤. If

the wallbox or charging station is not equipped with a charging cable, insert the plug of the optional charging cable into the wallbox or charging station socket as far as it will go. The indicator lamp ④  and status display ③ initially flash orange, and then green as soon as the high-voltage battery is charged.

#### Charging at a charging station (mode 4):

- ▶ Insert the CCS charge port into the vehicle socket as far as it will go. The indicator lamp ④  and status display ③ initially flash orange, and then green as soon as the high-voltage battery is charged.

When the charging cable is connected to the vehicle, the drive system cannot be started and the vehicle cannot be moved.

The charging process is aborted if the hood is opened during this process (only applies to mode 4).

When the charging process is started, the estimated charging time is displayed in the instrument cluster. The charging prediction shows the predicted state of charge at the set departure time or the time at which the high-voltage battery will be fully charged.

The charging prediction may display the following information:

- the predicted state of charge at a set departure time
- the time at which the high-voltage battery will be fully charged
- the time at which the high-voltage battery will reach the preset maximum state of charge

Observe any information displayed in the instrument cluster:



- Charging prediction (→ page 108)
- Display messages (→ page 227)
- ⓘ Depending on the temperature, the fan and battery cooling system may audibly switch on during the charging process.
- ⓘ If the vehicle is connected to the alternating current mains supply (mode 2 or 3), the high-voltage battery will be recharged automatically as needed or when electrical consumers such as the pre-entry climate control are activated.

## Ending the charging process

### Requirements:

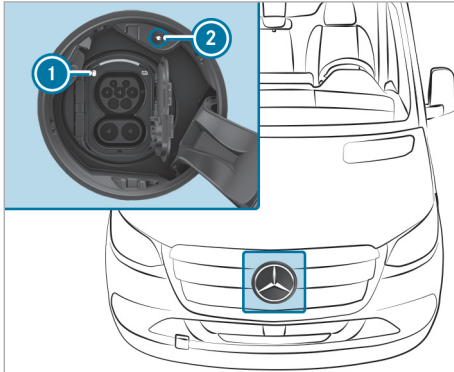
- The distance of the key to the vehicle socket is no greater than 3 ft (1 m) or the vehicle is unlocked.



- ▶ Press charging interruption button ②. The charging process is ended after a short time. If indicator lamp  ① then lights up white, the vehicle socket is unlocked.
- ① Instead of pressing charging interruption button ②, you can press the central locking button on the key four times within 2 seconds.
- ▶ Remove the charge port from the vehicle socket within 30 seconds. Only after charging with alternating current (mode 2/3) does the vehicle socket lock again after a period of 30 seconds, and the charging process resumes.
- ① If you cannot remove the charge port, repeat the unlocking procedure. If the charge port remains locked, unlock the charge port with the emergency release (→ page 114).
- ▶ Close it, or close the socket cover and the socket flap.
- ▶ Remove the charge port from the mains socket, or from the socket on the wallbox/charging station, and stow the vehicle charging cable safely in the vehicle.
- ① After the charge port has been disconnected, the left  indicator lamp ① on the vehicle socket remains lit for some time before going out.

## Unlocking the charge port with the emergency release

**⚠ WARNING** Risk of burns from hot components in the engine compartment

Certain components in the engine compartment can be very hot, e.g. the drive system and the cooler.

- ▶ Allow the drive system to cool down and touch only the components described below.

If you must unlock the charge port mechanically, touch only the following components:

- hood
- emergency release cable

**! NOTE** Damaged or dirty vehicle socket when the socket flap is open

- ▶ Always keep the socket cover and the socket flap closed when there is no charging cable connected. This protects the vehicle socket from dirt and damage.
- ▶ Make sure that the socket cover is closed properly before closing the socket flap. This can otherwise result in damage which may prevent the socket flap from being opened again.

### Requirements:

- The charge port cannot be disconnected.
- The distance of the key to the vehicle socket is no greater than 3 ft (1 m) or the vehicle is unlocked.

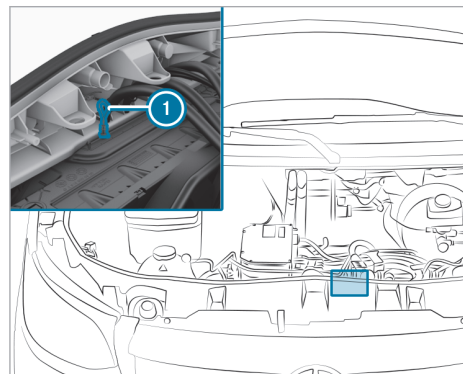

- ▶ Open the hood (→ page 171).

- ▶ Press the charging interruption button on the vehicle socket and check the indicator lamps to ensure that the charging process has ended (→ page 114).
- ▶ Pull cable ① upward and disconnect the charge port from the vehicle socket within 30 seconds.
- ▶ Close the socket cover and the charge socket flap of the vehicle socket.
- ▶ Have the vehicle socket checked at a qualified specialist workshop.

## Parking

### Parking the vehicle

**⚠ WARNING** Risk of accident and injury due to children left unattended in the vehicle

If you leave children unattended in the vehicle, they could, in particular:

- open doors, thereby endangering other persons or road users.
- get out and be struck by oncoming traffic.
- operate vehicle equipment and become trapped, for example.

In addition, the children could also set the vehicle in motion by, for example:

- releasing the parking brake.
- changing the gearbox position.
- starting the vehicle.

- ▶ Never leave children unattended in the vehicle.
- ▶ When leaving the vehicle, always take the key with you and lock the vehicle.
- ▶ Keep the key out of reach of children.

**⚠ WARNING** Risk of accident and injury caused by an insufficiently secured vehicle rolling away

If the vehicle is not securely parked sufficiently, it can roll away in an uncontrolled way even at a slight downhill gradient.

- ▶ On uphill or downhill gradients, turn the front wheels so that the vehicle rolls towards the curb if it starts moving.
- ▶ Apply the parking brake.
- ▶ Switch the transmission to position **P**.

**ⓘ NOTE** Damage to the vehicle or the drive-train due to rolling away

- ▶ Always park your vehicle safely and according to legal requirements.
- ▶ Always properly secure the vehicle against rolling away.

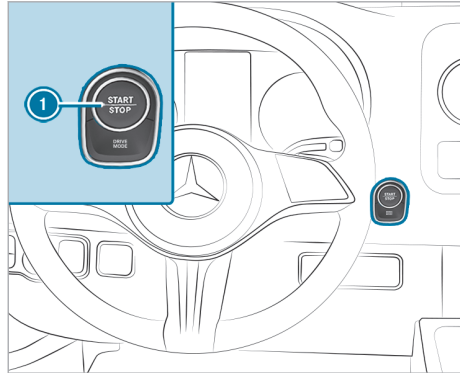

To ensure that the vehicle is properly secured against rolling away unintentionally, observe the following points.

- ▶ Always apply the parking brake.
- ▶ **On uphill or downhill gradients:** turn the front wheels towards the curb.
- ▶ Shift the transmission to position **P**.
- ▶ Switch off the vehicle by pressing button ①.
- ▶ Get out of the vehicle and lock it.
- ▶ **On uphill or downhill gradients:** secure the rear axle with a chock or an object without any sharp edges.

### Electric parking brake

#### Information on the electric parking brake

**⚠ WARNING** Risk of accident and injury if children are left unattended in the vehicle

If children are left unattended in the vehicle, they could in particular:

- open doors, thereby endangering other persons or road users.
- get out and be struck by oncoming traffic.
- operate vehicle equipment and become trapped, for example.



In addition, the children could also set the vehicle in motion, for example by:





- releasing the parking brake.
  - changing gear.
  - starting the vehicle.
- ▶ Never leave children unattended in the vehicle.
  - ▶ When leaving the vehicle, always take the SmartKey with you and lock the vehicle.
  - ▶ Keep the SmartKey out of the reach of children.

Observe the note on transporting animals in the vehicle (→ page 32).

For the automatic functions to work correctly, the driver must be seated in the correct seat position (→ page 56).

The function of the electric parking brake is dependent on the on-board electrical system voltage. If the on-board electrical system voltage is low or there is a malfunction in the system, the electric parking brake may not be able to be applied. In this case, the yellow  indicator lamp lights up.

In this case, park the vehicle in the following way:

- Park the vehicle on level ground and secure it to prevent it from rolling away.
  - Shift the transmission to position .
-  The electric parking brake is only actually applied when the red  and  (USA) indicator lamps or the red  (Canada) indicator lamps light up continuously.

It may not be possible to release a parking brake if the on-board electrical system voltage is low or if there is a malfunction in the system. Inform a qualified specialist workshop.

When the vehicle is stationary, the electric parking brake carries out a function test at regular intervals. Noises are normal in this process.

The automatic application of the parking brake only works after a previous journey.

### ■ Function of the electric parking brake

When the vehicle is switched off after a journey and the transmission is in position , the electric parking brake is automatically applied.





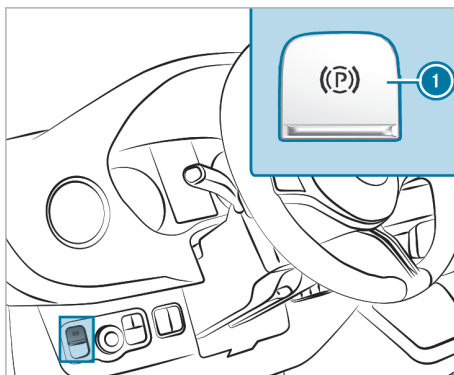

In addition, at least one of the following conditions must be fulfilled:



- the driver is not sitting in the driver's seat
- the belt buckle is undone



The electric parking brake is also automatically applied when the transmission is not in position P, but the following situations occur:



- there is a system malfunction
- the power supply is insufficient
- the vehicle is stationary for a long time

The red  and  (USA) or  (Canada) indicator lamps in the instrument cluster light up. The electric parking brake is only actually applied when the red  and  (USA) or  (Canada) indicator lamps light up continuously.



-  To prevent the electric parking brake from applying automatically, pull switch .

### ■ Releasing the electric parking brake automatically

The electric parking brake of your vehicle is released when all of the following conditions are fulfilled:

- The driver is sitting in the driver's seat.
- The driver is belted.
- The vehicle has been started.
-  or  is engaged and you depress the accelerator pedal.

or

You shift out of  into  or . You must also depress the accelerator if traveling on steep uphill gradients.

- When  is engaged, the rear-end doors must be closed.



## Applying/releasing the electric parking brake manually

**⚠ WARNING** Risk of accident and injury if children are left unattended in the vehicle











If children are left unattended in the vehicle, they could in particular:

- open doors, thereby endangering other persons or road users.
- get out and be struck by oncoming traffic.
- operate vehicle equipment and become trapped, for example.

In addition, the children could also set the vehicle in motion, for example by:



- releasing the parking brake.
- changing gear.
- starting the vehicle.

- ▶ Never leave children unattended in the vehicle.
- ▶ When leaving the vehicle, always take the SmartKey with you and lock the vehicle.
- ▶ Keep the SmartKey out of the reach of children.



- Observe "Notes on pets in the vehicle" (→ page 32).
- ▶ **To apply:** press the  switch when the vehicle is stationary.  
When the electric parking brake is applied, the red  and  (USA) or  (Canada) indicator lamps light up in the instrument cluster. The electric parking brake is only actually applied when the red  and  (USA) or  (Canada) indicator lamps light up continuously.  
It is also possible to apply the electric parking brake when the vehicle is switched off.
- ▶ **To release:** pull the  switch.  
The red  and  (USA) or  (Canada) indicator lamps in the instrument cluster go out.  
You may only release the electric parking brake if the vehicle is switched on with the start/stop button.

## Emergency braking

In the event of an emergency, you can brake the vehicle while it is in motion with the electric parking brake.

- ▶ While driving, press the  switch of the electric parking brake.  
The vehicle is braked as long as you keep the  switch of the electric parking brake depressed.  
The vehicle's brake lights light up.  
The longer the  switch of the electric parking brake is depressed, the greater the braking force.

During the braking procedure, you will receive the following feedback from the vehicle:

- A warning tone sounds.
- The **Release Parking Brake** message appears in the instrument cluster.
- The red  and  (USA) indicator lamps flash in the instrument cluster or the red  (Canada) indicator lamp flashes in the instrument cluster.

When the vehicle has been braked to a standstill, the electric parking brake is applied.

## Parking up the vehicle

### Measures for the 12 V on-board electrical system battery if the vehicle is idle for lengthy periods

- ▶ Seek advice from a qualified specialist workshop to avoid damage to the 12 V on-board electrical system battery due to deep discharge.
- ▶ If the 12 V on-board battery has been disconnected and is reconnected, fully charge the high-voltage battery. This will enable an optimized display of the range and an optimized charging time forecast.

### Measures for the high-voltage battery if the vehicle is idle for lengthy periods

- ▶ Park up the vehicle with the high-voltage battery at a state of charge between 30% and 50%.
- ▶ Do not keep the high-voltage battery continuously connected to power supply equipment.
- ▶ Check the state of charge of the high-voltage battery every two to three months.  
If the 12 V power supply is switched on, you can check the state of charge of the high-voltage battery with the on-board computer.
- ▶ If the charge level is insufficient, recharge the high-voltage battery (→ page 106).

- ⓘ The on-board computer displays the state of charge of the high-voltage battery on the instrument cluster display (→ page 139).

### Using the chock

Use the chock to provide additional safety to prevent the vehicle from rolling away, e.g. when parking or changing a wheel.

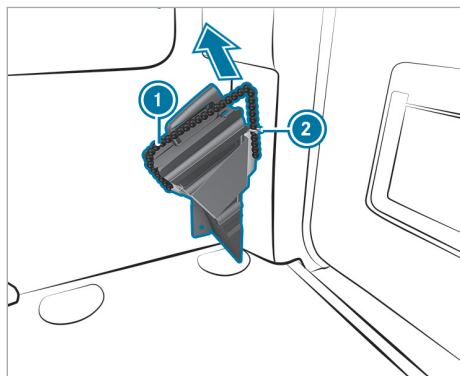

Chock in load/passenger compartment

- ▶ **To remove the chock:** pull holding rope ❶ slightly downwards and then remove it from holder ❷.
- ▶ Remove the chock.
- ⓘ When stowing it away, ensure that the chock is secured in the holder by holding rope ❶.

## Driving and driving safety systems

### Notes on driving systems and your responsibility

Your vehicle is equipped with driving systems that assist you in driving, parking and maneuvering the vehicle. The driving systems are only aids. They are not a substitute for you paying attention to your surroundings and do not relieve you of your responsibility pertaining to road traffic law. The driver is always responsible for maintaining a safe distance to the vehicle in front, for vehicle speed, for braking in good time and for staying in lane. Always pay attention to the traffic and intervene if necessary. Be aware of the limitations regarding the safe use of these systems.

Driving systems can neither reduce the risk of accident if you fail to adapt your driving style nor override the laws of physics. They cannot always

take into account road, weather or traffic conditions.

- ⓘ Some driving systems can regulate or limit the speed to a previously set value. If there is a change of drivers, make sure that you inform the new driver about the set cruise speed.

### Function of driving systems and driving safety systems

In this section, you will find information about the following driving systems and driving safety systems:

- ABS (**A**nti-**l**ock **B**raking **S**ystem) (→ page 118)
- ASR (**A**cceleration **S**kid **C**ontrol) (→ page 119)
- BAS (**B**rake **A**ssist **S**ystem) (→ page 119)
- ESP® (**E**lectronic **S**tability **P**rogram) (→ page 119)
- EBD (**E**lectronic **B**rake**f**orce **D**istribution) (→ page 121)
- Active Brake Assist (→ page 121)
- Cruise control (→ page 123)
- Hill Start Assist (→ page 124)
- HOLD function (→ page 125)
- Rear-view camera (→ page 126)
- Rear-view camera with inside rear-view mirror display (→ page 127)
- ATTENTION ASSIST (→ page 128)
- Blind Spot Assist (→ page 129)
- Lane Keeping Assist (→ page 131)

### Functions of ABS (anti-lock braking system)

Observe the important safety guidelines for the driving safety system.

ABS controls the brake pressure in critical situations:

- During braking, for instance, at maximum full-stop braking or if there is insufficient tire traction, the wheels are prevented from locking.
- The steerability of the vehicle in terms of physical possibilities is ensured when you are braking.
- ABS is active at speeds above approximately 3 mph (5 km/h). On a slippery road surface, ABS will intervene even if you brake only gently.

### System limits

ABS may be impaired or may not function if a malfunction has occurred and the yellow  ABS warning lamp lights up continuously on the instrument cluster after the vehicle is started.

If ABS intervenes, you will feel pulsations in the brake pedal. The pulsating brake pedal may be an indication of hazardous road conditions and functions as a reminder to take extra care while driving.

**If ABS intervenes:** keep the brake pedal firmly depressed until the braking situation has passed.

**To carry out maximum full-stop braking:** fully depress the brake pedal.

### Function of BAS (Brake Assist System)

**⚠ WARNING** Risk of an accident caused by a malfunction in BAS (Brake Assist System)

If BAS is malfunctioning, the braking distance in an emergency braking situation is increased.

▶ Depress the brake pedal with full force in emergency braking situations. ABS prevents the wheels from locking.

BAS helps you by providing additional brake force in an emergency braking situation.

If you depress the brake pedal quickly, BAS will be activated:

- BAS will automatically boost the brake force of the brakes
- BAS can shorten the braking distance
- ABS will prevent the wheels from locking

When you release the brake pedal, the brakes will function as usual again. BAS will be deactivated.

### Functions of ASR (anti-slip control)

ASR can neither reduce the risk of an accident nor override the laws of physics if the driver does not pay attention when pulling away or accelerating. ASR is only an aid. Always adapt your driving style to suit the prevailing road and weather conditions.

**Vehicles without steering-wheel buttons:** if ASR is malfunctioning, the  indicator lamp will light up and the drive system performance may be reduced.

If ASR is malfunctioning, the  indicator lamp will light up in the instrument cluster and the drive system performance may be reduced.

ASR improves traction, i.e. the transfer of power from the tires to the road surface, for a sustained period and therefore also improves the driving stability of the vehicle. If the drive axle wheels start to spin, ASR will brake individual wheels on the drive axle and limit the output of the drive system. ASR thus assists you significantly when pulling away and accelerating, especially on wet or slippery roads.

If traction on the road surface is not sufficient, even ASR will not allow you to pull away without difficulty. The type of tires and total weight of the vehicle as well as the gradient of the road also play a crucial role.

If ASR intervenes, the  warning lamp in the instrument cluster will flash.

### Function of ESP® (Electronic Stability Program)

**⚠ WARNING** Risk of skidding if ESP® is malfunctioning

If ESP® is malfunctioning, ESP® cannot carry out vehicle stabilization. In addition, other driving safety systems are switched off.

- ▶ Drive on carefully.
- ▶ Have ESP® checked at a qualified specialist workshop.

**⚠ WARNING** Risk of skidding if ESP® is deactivated

If you deactivate ESP®, ESP® cannot carry out vehicle stabilization.

- ▶ ESP® should only be deactivated in the following situations.

If the surface requires, temporarily deactivate ESP® when pulling away (→ page 120).

Do not operate the vehicle on a roller dynamometer (e.g. for a performance test). If you have to operate the vehicle on a roller dynamometer, consult a qualified specialist workshop beforehand.

If ESP® is malfunctioning or automatically deactivated, the  warning lamp will light up yellow in the instrument cluster and the drive system output may be reduced.

- ① Only use wheels with the recommended tire size. Only then will ESP® function properly.

ESP® can, within physical limits, monitor and improve driving stability and traction in the following situations:

- When pulling away on wet or slippery road surfaces
- When braking
- If you are driving faster than 50 mph (80 km/h) in strong crosswinds

If the vehicle is deviating from the direction desired by the driver, ESP® can stabilize the vehicle by performing the following actions:

- One or more wheels are braked
- The drive system performance is adapted depending on the situation

When ESP® is deactivated by the driver, the  warning lamp in the instrument cluster lights up continuously.

- Vehicle stabilization may be delayed
- Crosswind Assist is still active
- The wheels may start to spin
- ASR traction control is no longer active

If ESP® is deactivated by the driver, ESP® will continue to support you when braking.

If the  warning lamp in the instrument cluster flashes, one or more tires have reached their grip limit:

- Adapt your driving style to suit the prevailing road and weather conditions
- Do not deactivate ESP® under any circumstances

### Activating/deactivating ESP® (Electronic Stability Program)

Multimedia system:

 **Settings** **Quick Access**  
**ESP**

- ① ESP® can be activated and deactivated only via quick access when at least one other function is available in quick access. Otherwise, you can find ESP® on the **Assistance** menu.

**Select ESP.**

A prompt will appear.

**Select On or  Off.**

If the ESP® OFF  warning lamp lights up steadily on the instrument cluster, ESP® is deactivated.

Observe the information on warning lamps and display messages that may appear on the instrument cluster.

### Function of ESP® Crosswind Assist

Crosswind Assist does not react under the following conditions:

- The vehicle is subjected to severe jolts and vibrations, e.g. as a result of uneven surfaces or potholes.
- The vehicle loses traction, e.g. on snow or ice or when hydroplaning.
- The driver is performing sudden and large steering movements.

Crosswind Assist is operational again as soon as the driving conditions return to normal.

Crosswind Assist detects strong crosswind gusts that can impair the ability of your vehicle to drive straight ahead. Crosswind Assist intervenes depending on the direction and strength of the crosswind.

A stabilizing brake application helps you to keep the vehicle on track.

Information is shown on the instrument cluster in the event of a clearly perceptible intervention by Crosswind Assist.

Crosswind Assist is active above a vehicle speed of 50 mph (80 km/h) when driving straight or during slight cornering.

### Function of ESP® trailer stabilization

**⚠ WARNING** Risk of accident in poor road and weather conditions

In poor road and weather conditions, the trailer stabilization cannot prevent lurching of the vehicle/trailer combination. Trailers with a high center of gravity may tip over before ESP® detects this.

**▶ Always adapt your driving style to suit the current road and weather conditions.**

ESP® trailer stabilization counteracts critical driving situations in good time and thereby provides considerable assistance when driving with a trailer. Trailer stabilization is part of ESP®.

If the sensor system and evaluation logic detect trailer swinging movements, ESP® trailer stabilization initially brakes individual vehicle wheels in a targeted manner. It thus counteracts swinging movements. If the swinging movements do not stop, the vehicle is braked until the vehicle/trailer combination is stabilized. If necessary, the vehicle's engine output is limited.

If your vehicle with trailer (vehicle/trailer combination) starts to swerve, you are able to stabilize the vehicle/trailer combination only by braking. ESP® trailer stabilization helps you to stabilize the vehicle/trailer combination in this situation.

ESP® trailer stabilization is active at speeds above approx. 40 mph (65 km/h).

If ESP® is deactivated because of a malfunction, trailer stabilization will not function.

### Function of EBD (Electronic Brakeforce Distribution)

EBD has the following characteristics:

- monitoring and controlling the brake pressure on the rear wheels
- improving driving stability when braking, especially on bends

### Functions of Active Brake Assist

Active Brake Assist consists of the following functions:

- Distance warning function
- Autonomous braking function
- Situation-dependent brake force boosting

Active Brake Assist can help you to minimize the risk of a collision with vehicles or pedestrians or to reduce the effects of such a collision.

If Active Brake Assist has detected a risk of collision, you will be warned visually and acoustically.

If you do not react to the visual warning or warning tone, autonomous braking may be initiated in critical situations.

If there are pedestrians and cyclists crossing: in especially critical situations, Active Brake Assist may initiate autonomous braking directly. In this case, the visual warning and warning tone will occur at the same time as the brakes are applied.

If you apply the brakes yourself in a critical situation or depress the brake pedal during autonomous braking, situation-dependent brake force boosting will occur. The brake pressure will increase up to maximum full-stop braking if necessary. Situation-dependent brake force boosting will intervene only when the brakes are applied firmly; otherwise, it will remain within the autonomous braking process.

#### **⚠ WARNING** Risk of accident in case of limited detection performance of Active Brake Assist

Active Brake Assist cannot always clearly identify objects and complex traffic situations.

Due to the system, unjustified interventions or non-interventions by Brake Assist may occur in complex driving situations. In these cases, as well as in the event of malfunctions of Active Brake Assist, the brake system continues to be available with full brake force boosting and BAS.

- ▶ Always keep a close eye on the traffic situation and do not rely solely on Active Brake Assist. Active Brake Assist is only an aid. The driver of the vehicle is responsible for maintaining a safe distance to the vehicle in front, for vehicle speed and for braking in good time.
- ▶ Be ready to brake and take evasive action if necessary.

Also observe the system limits of Active Brake Assist.

#### **The individual subfunctions are available in the following speed ranges:**

##### **Distance warning function**

The distance warning function will warn you at speeds greater than approximately 4 mph (7 km/h) if your vehicle is critically close to a vehicle or pedestrian.

An intermittent warning tone will sound and the  distance warning lamp will light up on the instrument cluster.

Brake immediately or take evasive action, provided it is safe to do so and the traffic situation allows it.

The distance warning function can assist you with an intermittent warning tone and warning lamps in the following situations:

Vehicles traveling in front	Stationary vehicles	Crossing vehicles	Crossing pedestrians/cyclists	Stationary pedestrians
Up to approx. 155 mph (250 km/h)	Up to approx. 124 mph (200 km/h)	No reaction	Up to approx. 37 mph (60 km/h)	No reaction

#### Autonomous braking function

The autonomous braking function may intervene at speeds starting from approximately 4 mph (7 km/h) in the following situations:

Vehicles traveling in front	Stationary vehicles	Crossing vehicles	Crossing pedestrians/cyclists	Stationary pedestrians
Up to approx. 155 mph (250 km/h)	Up to approx. 124 mph (200 km/h)	No reaction	Up to approx. 37 mph (60 km/h)	No reaction

#### Situation-dependent brake force boosting

Situation-dependent brake force boosting may intervene at speeds starting from approximately 4 mph (7 km/h) in the following situations:

Vehicles traveling in front	Stationary vehicles	Crossing vehicles	Crossing pedestrians/cyclists	Stationary pedestrians
Up to approx. 155 mph (250 km/h)	Up to approx. 50 mph (80 km/h)	No reaction	Up to approx. 37 mph (60 km/h)	No reaction

#### Canceling brake application by Active Brake Assist

You can cancel brake application by Active Brake Assist at any time by:

- Fully depressing the accelerator pedal or with kickdown.
- Fully releasing the brake pedal (only during situation-dependent brake force boosting).

Active Brake Assist may cancel brake application if one of the following conditions is fulfilled:

- You maneuver to avoid the obstacle.
- There is no longer a risk of collision.
- An obstacle is no longer detected in front of your vehicle.

#### System limits

The system may be impaired or may not function in the following situations:

- The sensors are affected by snow, rain, fog or heavy spray.
- The sensors are dirty, fogged up, damaged or obscured.
- The sensors are affected by interference from other radar sources, e.g. intense radar reflections in parking garages.
- If a loss of tire pressure or a defective tire has been detected and displayed.
- Full system performance is not yet available for a few seconds after you start the vehicle or drive off.

The system may not react correctly in the following situations:

- In complex traffic situations, objects may not always be clearly detected.
- Pedestrians or vehicles move quickly into the detection range of the sensors.
- Pedestrians are obscured by other objects.
- Narrow-radius bends may hamper the system's ability to react correctly.

### Setting Active Brake Assist

#### Requirements

- The vehicle is switched on.

Multimedia system:

➔  ➔ Settings ➔ Assistance  
➔ Active Brake Assist

The following settings are available:

- Early
- Medium
- Late
- Off

 It is recommended that you always leave Active Brake Assist activated.

▶ Select a setting.

The last active setting will be selected automatically every time the vehicle is started.

Exception: if the last setting was **Off**, the **Medium** setting will be activated automatically the next time the vehicle is started.



#### Deactivating Active Brake Assist

 It is recommended that you always leave Active Brake Assist activated.

▶ Select **Off**.

The distance warning function and the autonomous braking function will be deactivated.

When the vehicle is next started, the **Medium** setting will automatically be activated.

 If Active Brake Assist is deactivated, the  symbol will appear on the status bar of the instrument cluster.

### Cruise control

#### Function of cruise control

To maintain a previously stored speed, cruise control accelerates and brakes the vehicle independently.

If you accelerate to overtake, for example, the stored speed will not be deleted. If you remove your foot from the accelerator pedal after overtaking, cruise control will resume speed regulation back to the stored speed.

Cruise control is operated using the corresponding steering wheel buttons. You can set any speed from 12 mph (rounded) (20 km/h).

If you fail to adapt your driving style, cruise control can neither reduce the risk of an accident nor override the laws of physics. It cannot take into account road, weather or traffic conditions. Cruise control serves solely as an aid. You are responsible for the distance to the vehicle in front, for vehicle speed, braking in good time and for staying in your lane.

The status of cruise control and the stored speed are shown on the instrument cluster.

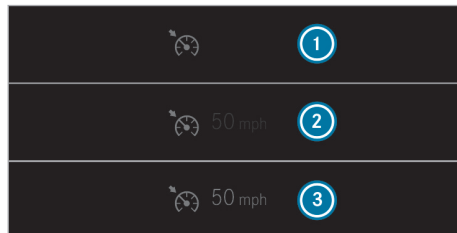

Instrument cluster display (color display)

- 1 Cruise control is selected.
- 2 Set speed gray: speed is stored, cruise control is deactivated.
- 3 Set speed green: speed is stored, cruise control is activated.

#### System limits

Cruise control may be unable to maintain the stored speed on uphill gradients. The stored speed will be resumed when the gradient levels out.

Do not use cruise control in the following situations:

- In the event of frequent changes in speed, e.g. in heavy traffic or winding roads
- On slippery roads. The wheels on the drive axle may lose traction upon acceleration, causing the vehicle to begin skidding.
- When visibility is poor

### Operating cruise control

**⚠ WARNING** Risk of accident due to stored speed

If you call up the stored speed and this is lower than your current speed, the vehicle decelerates.

- ▶ Take into account the traffic situation before calling up the stored speed.

#### Requirements:

- Cruise control is selected.
- ESP® must be activated but not intervening.
- The vehicle speed is at least 15 mph (20 km/h).
- The transmission is in position **D**.

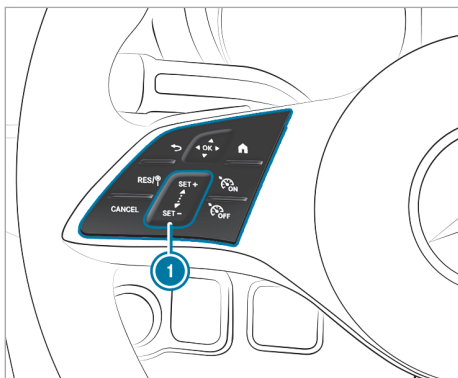

#### Switching on cruise control:

- ▶ Press **CRUISE ON**.

#### Activating cruise control:

- ▶ Press **SET+** or **SET-** on switch panel **1**.  
The current speed will be stored and maintained by the vehicle.

or

- ▶ Press **RES/Ⓢ**.

The last stored speed will be called up and maintained by the vehicle.

The current vehicle speed will be stored if the last stored speed has been deleted.

- ⓘ When you switch off the vehicle, the last speed stored will be deleted.

#### Increasing/reducing the stored speed:

- ▶ To increase the stored speed: swipe over switch panel **1** from the bottom up.

- The stored speed will be increased by 1 mph (1 km/h).

- ▶ To reduce the stored speed: swipe over switch panel **1** from the top down.

- The stored speed will be reduced by 1 mph (1 km/h).

or

- ▶ Press **SET+** or **SET-** briefly on the switch panel **1**.

The stored speed will be increased or reduced to the following values depending on the unit:

- **mph:** the next value ending in 5 or 0
- **km/h:** the next value ending in 0

or

- ▶ Accelerate the vehicle to the desired speed.

- ▶ Press **SET+** on the switch panel **1**.

#### Deactivating cruise control:

- ▶ Press **CANCEL**.

#### Switching off cruise control:

- ▶ Press **CRUISE OFF**.

- ⓘ If you brake, deactivate ESP®, or if ESP® intervenes, cruise control will be deactivated.

### Setting a speed limit for winter tires

Multimedia system:

→ **HOME** ▶ **Settings** ▶ **Vehicle**  
▶ **Winter Tire Limit**

- ▶ Select a speed or deactivate the function.

#### Information on Hill Start Assist

Hill Start Assist holds the vehicle for a short time when pulling away on a hill under the following conditions:

- The transmission is in position **D** or **R**.
- The parking brake has been released.



This gives you enough time to move your foot from the brake pedal to the accelerator pedal and depress it before the vehicle begins to roll.

**⚠ WARNING** Risk of accident and injury due to the vehicle rolling away

After a short time, Hill Start Assist no longer holds the vehicle.

- ▶ Swiftly move your foot from the brake pedal to the accelerator pedal. Do not leave the vehicle when it is being held by Hill Start Assist.

## HOLD function

### ■ Notes on the HOLD function

#### Requirement

The seat occupancy recognition on the driver's seat has detected that the driver has fastened the seat belt.

#### Function

The HOLD function holds the vehicle at a standstill without requiring you to depress the brake pedal, e.g. when you are pulling away on steep slopes or waiting in traffic. When you depress the accelerator pedal to pull away, the braking effect will be canceled and the HOLD function deactivated.

The HOLD function is only an aid. The responsibility for the vehicle safely standing still remains with the driver.

#### System limits

The HOLD function is intended only to provide assistance when you are driving and is not a sufficient means of safeguarding the vehicle against rolling away when stationary.

The incline cannot be greater than 30%.

### ■ Activating/deactivating the HOLD function

#### Requirements:

- The driver is seated and their seat belt is fastened.
- The vehicle is switched on.
- The electric parking brake has been released.
- The transmission is in position **D**, **R** or **N**.

### Activating the HOLD function

**⚠ WARNING** Risk of an accident due to the HOLD function being active when you leave the vehicle

If the vehicle is only braked with the HOLD function it could, in the following situations, roll away:

- If there is a malfunction in the system or in the power supply.
  - If the HOLD function is deactivated by depressing the accelerator pedal or brake pedal, e.g. by a vehicle occupant.
- ▶ Always secure the vehicle against rolling away before you leave it.

**! NOTE** Damage due to automatic braking

When Active Brake Assist or the HOLD function is activated, the vehicle brakes automatically in certain situations.

To avoid damage to the vehicle, deactivate these systems in the following or similar situations:

- ▶ When towing
- ▶ In a car wash

- ▶ Make sure that the activation conditions are met.
- ▶ Depress the brake pedal until the **HOLD** display appears on the instrument cluster display. The HOLD function is activated. You can release the brake pedal.
- ⓘ If depressing the brake pedal the first time does not activate the HOLD function, wait briefly and then try again.

### Deactivating the HOLD function

- ▶ Depress the accelerator pedal to pull away.

or

- ▶ Depress the brake pedal until the **HOLD** display disappears from the display on the instrument cluster.
- ⓘ After a while, the transmission will shift to position **P** to relieve the load on the service brake.

When the HOLD function is activated, the transmission will automatically shift to position **P** in the following situations:

- The driver leaves the driver's seat.
- The driver's door is opened.
- The vehicle is switched off.

## Rear-view camera

### Function of the rear view camera

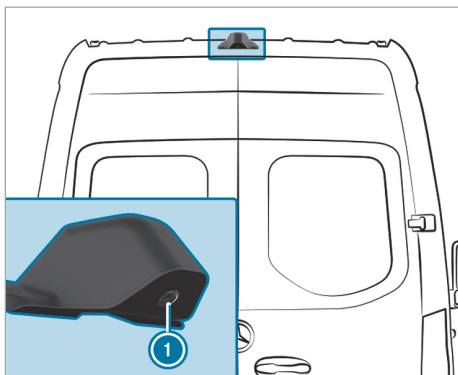

Dynamic guide lines show the vehicle's path for the current steering movement. This helps you to orient yourself and to avoid obstacles when backing up.

The image from rear view camera ❶ appears in the multimedia system when the following conditions are fulfilled:

- The vehicle is switched on and reverse gear is engaged or the rear-end doors are opened.

This allows the area behind the vehicle to be monitored.

When the rear-end doors are closed, the image from the rear view camera is switched off after approximately ten seconds.

The rear view camera serves solely as an aid. It is not a substitute for you having to pay attention to your surroundings. You are always responsible for safe maneuvering and parking. Ensure that there are no persons, animals or objects etc. in the maneuvering area while maneuvering and parking.

The rear view camera may show a distorted view of obstacles, show them incorrectly or not show them at all. The rear view camera cannot show all objects in immediate proximity to, or beneath, the rear bumper. It will not warn you of a collision, people or objects.

You can select from the following views:

- Normal view
- Wide-angle view
- Trailer view

The area behind the vehicle is displayed as a mirror image, as it would appear in the inside rearview mirror.

### System limits

The rear view camera will not function, or will only partially function, in the following situations, for example:

- If there is heavy rain, snow or fog.
- If ambient light is poor, e.g. at night.
- If the area is illuminated with fluorescent lighting (the display may flicker).
- if the temperature changes very quickly, for example, if you drive out of the cold into a heated garage in winter.
- If the ambient temperature is very high.
- If the camera lens is obstructed, dirty or fogged up. Observe the notes on cleaning the rear view camera (→ page 175).
- The camera or rear of your vehicle is damaged. In this case, have the camera, its position and its setting checked at a qualified specialist workshop.

The field of vision and other functions of the rear view camera may be restricted by additional vehicle attachments at the rear of the vehicle (e.g. a cargo liftgate).

- ❶ The display contrast may be impaired due to incident sunlight or other light sources. Particular attention is required in these conditions.
- ❶ Have the display repaired or replaced if, for example, its use is significantly restricted due to pixel errors.
- ❶ Objects not at ground level can appear further away than they actually are. This includes, for example:
  - the bumper of a vehicle parked behind you
  - the drawbar of a trailer
  - the ball neck of a trailer hitch
  - the tail-end of a truck
  - slanted posts

Only use the guide lines of the camera image for orientation. Do not travel further than the lowest horizontal guide line when approaching objects. You may otherwise damage your vehicle and/or the object.

### Camera perspectives

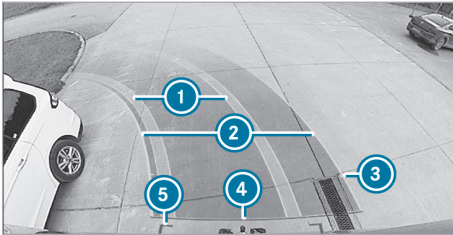

Normal view

- ① Yellow lanes mark the course the tires will take with the current steering movement (dynamic)
- ② Yellow guide line, vehicle width (driven surface) depending on the current steering movement (dynamic)
- ③ Marking at a distance of approximately 3.3 ft (1.0 m) (the rear-end doors can still be opened completely)
- ④ Red guide line at a distance of approximately 1.0 ft (0.3 m) from the rear area
- ⑤ Red guide lines at a distance of approximately 8 in (0.2 m) from the rear area, vehicle width including outside mirrors



Wide-angle view

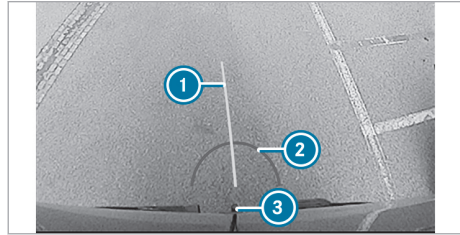

Trailer view (if trailer hitch is installed)

- ① Yellow guide line, locating aid
- ② Red guide line at a distance of approximately 1.0 ft (0.3 m) from the ball head of the trailer hitch
- ③ Ball head of the trailer hitch

### Rear-view camera with inside rear-view mirror display

#### Function of the rear-view camera with inside rear-view mirror display

The rear-view camera is connected to the vehicle's inside rear-view mirror. When you engage reverse gear, the rear-view camera's image will appear in the left area of the inside rear-view mirror. This will allow you to see what is behind the vehicle when backing up.

The rear-view camera with an inside rear-view mirror display is only an aid. It is not a substitute for your attention to your surroundings. You are always responsible for safe maneuvering and parking. Ensure that there are no persons, animals or objects etc. in the maneuvering area while maneuvering and parking.

The rear-view camera with an inside rear-view mirror display may show a distorted view of obstacles or may show them incorrectly or not at all. It cannot show all objects very near to or under the rear bumper. It will not warn you of a collision, people or objects.

The area behind the vehicle is displayed as a mirror image.

#### System limits

The rear-view camera with an inside rear-view mirror display will not function, or will function only partially, in the following situations:

- If there is heavy rain, snow or fog.
- If the ambient light is poor, e.g. at night

- If the area is illuminated with fluorescent lighting, the inside rear-view mirror display may flicker
- If there is a rapid change in temperature, e.g. if, in the winter, you drive out of the cold into a heated garage
- If the ambient temperature is very high
- If the camera lens is obstructed, dirty or fogged up. Observe the notes on cleaning the rear-view camera (→ page 175).
- If the camera or rear of your vehicle is damaged. In this case, check the camera's position and setting at a qualified specialist workshop.

The field of vision and other functions of the rear-view camera may be restricted due to additional accessories on the rear of the vehicle (e.g. license plate bracket or bicycle rack).

- ⓘ The inside rear-view mirror display contrast may be impaired due to incident sunlight or other light sources. In this case, pay particular attention.
- ⓘ Have the inside rear-view mirror repaired or replaced if its use is considerably restricted due to pixel errors, for example.
- ⓘ Objects that are not at ground level will appear further away than they are.

Examples of such objects:

- the bumper of a vehicle parked behind
- the drawbar of a trailer
- the ball neck of a trailer hitch
- the tail-end of a truck
- slanted posts

### ■ Displaying and hiding the inside rearview mirror display

#### Displaying

- ▶ Engage reverse gear.  
The image from the rear view camera appears on the left side of the inside rearview mirror.
- ⓘ Observe the system limits of the rear view camera with an inside rearview mirror display.

#### Hiding

- ▶ Select another drive range.  
or
- ▶ Switch off the drive system.  
The display will be hidden after a short time.

## ATTENTION ASSIST

### ■ Function of ATTENTION ASSIST

ATTENTION ASSIST can assist you on long, monotonous journeys, e.g. on highways and trunk roads. If ATTENTION ASSIST detects indicators of fatigue or increasing lapses in concentration on the driver's part, it suggests taking a break.

ATTENTION ASSIST serves solely as an aid. It cannot always promptly detect fatigue or lapses in concentration. The system is not a substitute for a well-rested and attentive driver. On long journeys, take regular, timely breaks to allow for adequate recovery.

You can choose between two settings:

- **Standard:** normal system sensitivity.
- **Sensitive:** higher system sensitivity. The driver is warned at an earlier stage, and the attention level detected by the system is adapted accordingly.

If fatigue or increased lapses in concentration are detected, the [Attention Assist: Take a Break!](#) warning appears in the instrument cluster. You can acknowledge the message and take a break if necessary. If you do not take a break and ATTENTION ASSIST continues to detect increasing lapses in concentration, you will be warned again after a minimum of 15 minutes.



Display of attention level in the instrument cluster (example)

You can have the following status information for ATTENTION ASSIST displayed in the Assistance menu of the on-board computer:

- journey time since the last break
- The more segments of the circle displayed, the higher the detected attention level. Fewer seg-

ments are displayed in the circle as the attention level decreases, with the color of the diminishing circle segments changing from green, to orange, to red accordingly.

If the ATTENTION ASSIST cannot calculate the attention level and cannot issue a warning, the **Attention Level** message appears.

If a warning is displayed in the instrument cluster, the multimedia system offers to search for a rest area. You can select a rest area and start navigation to this rest area. This function can be activated and deactivated in the multimedia system.

If ATTENTION ASSIST is deactivated, the  symbol appears in the assistance graphic in the instrument cluster when the vehicle is running. ATTENTION ASSIST is activated automatically when the vehicle is restarted. The last selected sensitivity level remains stored.

### System limits

ATTENTION ASSIST is active in the 37 mph (60 km/h) to 124 mph (200 km/h) speed range.

The functionality of ATTENTION ASSIST is restricted, and warnings may be delayed or not issued at all in the following situations:

- The journey is less than approximately 30 minutes
- Road conditions are poor (uneven road surface or potholes)
- The vehicle is subjected to a strong crosswind
- You have a sporty driving style (high cornering speeds or high rates of acceleration)
- The time is set incorrectly
- You change lanes and vary your speed frequently in active driving situations

The ATTENTION ASSIST drowsiness or attentiveness assessment is deleted and restarted when continuing the journey in the following situations:

- You switch off the vehicle.
- If you unfasten your seat belt and open the driver's door (e.g. to change drivers or take a break).

### Setting ATTENTION ASSIST

Multimedia system:

  **» Settings** **» Assistance**  
**» Attention Assist**

### Setting options

- ▶ Select **Standard**, **Sensitive** or **Off**.

### Suggesting a rest area

- ▶ Select **Suggest Rest Area**.
- ▶ Activate or deactivate the function. If ATTENTION ASSIST detects fatigue or increasing lapses in concentration, the system suggests a nearby rest area.
- ▶ Select a suggested rest area. You are guided to the selected rest area.

### Blind Spot Assist

#### Function of Blind Spot Assist with exit warning

Blind Spot Assist uses two lateral, rear-facing radar sensors to monitor the area directly next to and at the side behind the vehicle.

 USA only:

This device has been approved by the FCC as a "Vehicular Radar System". The radar sensor is intended for use in an automotive radar system only. Removal, tampering, or altering of the device will void any warranties, and is not permitted by the FCC. Do not tamper with, alter or use in any non-approved way.

Any unauthorized modification to this device could void the user's authority to operate the equipment.

#### **WARNING** Risk of accident despite Blind Spot Assist

Blind Spot Assist does not react to either stationary objects or vehicles approaching and overtaking you at a greatly different speed.

Blind Spot Assist cannot warn drivers in these situations.

- ▶ Always pay careful attention to the traffic situation and maintain a safe distance at the side of the vehicle.

Blind Spot Assist is only an aid. It may fail to detect some vehicles and is no substitute for attentive driving. Ensure that there is sufficient distance to the side from other road users and obstacles.

If a vehicle is detected above speeds of approximately 7.5 mph (12 km/h) and this vehicle subsequently enters the detection range directly next to your vehicle, the warning lamp in the outside mirror lights up red.

- i** When a trailer is connected, the radar sensor's field of vision may be impaired, thereby making limited monitoring possible. Always pay careful attention to the traffic situation and maintain a safe distance at the side of the vehicle.

If a vehicle is detected close to your vehicle in the lateral detection range and you switch on the turn signal indicator in the corresponding direction, a warning tone sounds. The red warning lamp in the outside mirror flashes. If the turn signal indicator remains switched on, all other detected vehicles are indicated only by the flashing of the red warning lamp.

If you overtake a vehicle quickly, no warning is given.

### Exit warning

The exit warning is an additional function of Blind Spot Assist and warns vehicle occupants when leaving the vehicle about any approaching vehicles.

#### **▲ WARNING** Risk of accident despite exit warning

The exit warning neither reacts to stationary objects nor to persons or road users approaching you at a greatly differing speed.

The exit warning cannot warn drivers in these situations.

- ▶ Always pay particular attention to the traffic situation when opening the doors and make sure there is sufficient clearance.

- i** An exit warning is not issued for sliding doors and rear-end doors.

#### Overview

When the vehicle is stationary, an object is detected from behind in the detection range.	Red warning lamp in the outside mirror
When the vehicle is stationary, a door on the relevant side of the vehicle is opened. An object which is close to your vehicle is detected in the detection range.	Collision warning

- i** This additional function is only available when Blind Spot Assist is activated and up to a maxi-

mum of three minutes after the drive system has been switched off. The end of the availability of the exit warning function is indicated by a series of flashes in the outside mirror.

The exit warning function is only an aid and is no substitute for the attentiveness of the vehicle occupants. Responsibility lies with the vehicle occupants when opening doors and leaving the vehicle.

### System limits

Blind Spot Assist and the exit warning function may be limited in the following situations:

- if there is dirt on the sensors or the sensors are obscured
- if there is poor visibility, e.g. due to fog, heavy rain, snow or spray
- if narrow vehicles are within the detection range, e.g. bicycles
- if lanes are very wide
- if lanes are very narrow
- if vehicles are not driving in the middle of their lane

- i** Stationary or slow-moving objects are not displayed.

Warnings may be issued in error when driving close to crash barriers or similar solid lane borders. Warnings may be interrupted when driving alongside long vehicles such as trucks for a prolonged time.

Blind Spot Assist is not operational when reverse gear is engaged.

The exit warning function may be limited in the following situations:

- when the sensor is blocked by adjacent vehicles in narrow parking spaces
- when people are approaching

### ■ Activating/deactivating Blind Spot Assist

Multimedia system:

→  ▶ Settings ▶ Assistance

- ▶ Activate or deactivate **Blind Spot Assist**.

## Lane Keeping Assist

### Function of Lane Keeping Assist

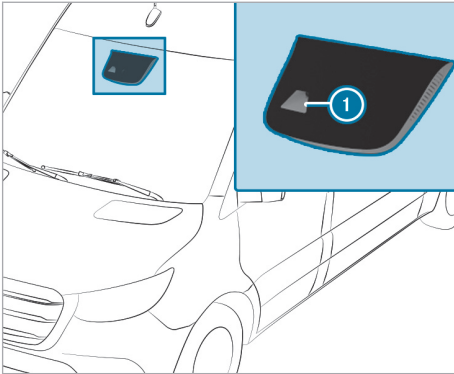

Lane Keeping Assist monitors the area in front of your vehicle with multifunction camera ①. It serves to protect you against unintentionally leaving your lane. You may also be warned by a noticeable vibration in the steering wheel or by a warning tone and by the status symbol flashing on the instrument cluster.

The function is available in the speed range between approximately 40 mph (60 km/h) and 100 mph (160 km/h).

The warning will be issued when the following conditions are met at the same time:

- If Lane Keeping Assist detects lane markings.
- If a front wheel drives over lane markings.

You can activate and deactivate the Lane Keeping Assist warning.

If you fail to adapt your driving style, Lane Keeping Assist can neither reduce the risk of accident nor override the laws of physics. It cannot take into account road, weather or traffic conditions. Lane Keeping Assist is only an aid and is not intended to keep the vehicle in the lane without the driver's cooperation. You are responsible for the distance to the vehicle in front, for vehicle speed, braking in good time and for staying in your lane.

### System limits

The system may be impaired or may not function in the following situations:

- If there is poor visibility, e.g. due to insufficient illumination of the road, if there are highly vari-

able shade conditions or in rain, snow, fog or spray.

- Glare from oncoming traffic, direct sunlight or reflections.
- There is dirt on the windshield in the vicinity of the multifunction camera or the camera is fogged up, damaged or obscured.
- Lane markings for one lane are absent or unclear, e.g. in a construction area.
- If the lane markings are worn away, dark or covered up.
- If the distance to the vehicle in front is too short and thus the lane markings cannot be detected.
- The lane markings change quickly, e.g. lanes branch off, cross one another or merge.
- The road is very narrow and winding.

## Trailer operation

### Notes on trailer operation

**▲ WARNING** Risk of accident and injury if the tongue weight is exceeded

The carrier system may detach from the vehicle, thereby endangering other road users.

- ▶ Always comply with the permissible tongue weight when using a carrier.

**▲ WARNING** Risk of accident due to unsuitable ball neck

If you install an unsuitable ball neck, the trailer hitch and the rear axle may be overloaded.

This can significantly impair the driving characteristics and the trailer may become loose. There is a risk of fatal injury.

- ▶ Only install a ball neck that complies with the permissible dimensions and is designed for the requirements of trailer operation.
- ▶ Do not modify the ball neck or the trailer hitch.

You can find specifications regarding the ball neck on the trailer's identification plate. You can find specifications regarding the trailer on the towing vehicle's identification plate and in the Technical Data (→ page 223).



**⚠ WARNING** Risk of accident and injury due to incorrectly installed ball neck

If the ball neck is not properly mounted and secured, it may come loose along with the trailer while the vehicle is in motion and endanger other road users. There is a risk of fatal injuries.

- ▶ Mount and secure the ball neck as described in the installation instructions of the ball neck manufacturer.
- ▶ With the ball neck mounted, always make sure it is properly secured before commencing a journey.

**⚠ WARNING** Risk of accident due to a ball neck that is not correctly installed or secured

If the ball neck is not correctly installed and secured, the trailer may come loose.

- ▶ Install and secure the ball neck as described in the ball neck manufacturer's installation instructions.
- ▶ If a ball neck is installed, ensure sure that it is properly secured before every journey.

**! NOTE** The operating permit may be invalidated due to the illegal installation of trailer hitches

The installation – including retrofitting – of a non-folding or non-removable trailer hitch that even partially conceals the license plate or the lighting system is prohibited.

- ▶ Observe the applicable legal regulations for the installation of trailer hitches.

Be sure to comply with the Operator's Manual of the manufacturer of the trailer coupling and the ball neck.

Place your vehicle/trailer combination on a surface that is as even as possible and secure it against rolling away (→ page 115). Couple and uncouple the trailer carefully.

When backing up the towing vehicle, ensure that there is no one between the vehicle and the trailer.

If you do not couple the trailer to the towing vehicle correctly, the trailer may become detached. Once it has been coupled and is roadworthy, the trailer must be in a horizontal position behind the towing vehicle.

Note the following regarding the tongue weight:

- Make full use of the maximum tongue weight, where possible.
- Never allow the tongue weight to fall below a legally prescribed minimum; the tongue weight must always be positive.
- Do not exceed or fall below the permissible tongue weights – this must be observed during loading and unloading of the trailer.

Do not exceed the following values:

- Permitted braked or unbraked towing capacity  
The maximum permissible towing capacity for unbraked trailers is 1,653 lbs (750 kg).
- Permissible rear axle load of the towing vehicle
- Gross vehicle weight rating of the towing vehicle
- Gross vehicle weight rating of the trailer
- Permissible gross combination weight
- Maximum permissible speed of the trailer

The relevant permitted values, which must not be exceeded, can be found in the following places:

- in your vehicle documents
- on the identification plate of the trailer hitch
- on the trailer identification plate
- on the vehicle identification plate

If there are discrepancies between the values, the lowest one shall apply.

Before driving off, ensure the following:

- The tire pressure on the rear axle of the towing vehicle has been set for the maximum load.
- The headlamps have been set correctly.

Values approved by the manufacturer can be found on the identification plates and in the section for the towing vehicle (→ page 193).

Your vehicle will behave differently with a trailer relative to without a trailer:

- The vehicle/trailer combination will be heavier.
- The vehicle/trailer combination will be restricted in its acceleration and gradeability.
- The vehicle/trailer combination will have an increased braking distance.
- The vehicle/trailer combination will be more susceptible to crosswind gusts.



- The vehicle/trailer combination will require more sensitive steering.
- The vehicle/trailer combination will have a larger turning circle.

This may impair the vehicle's driving characteristics.

When driving with a vehicle/trailer combination, always adapt your speed to the current road and weather conditions. Drive carefully. Keep a sufficient safe distance.

Comply with the maximum permissible speed of 50 mph (80 km/h) or 62 mph (100 km/h), even in countries in which higher speeds are permitted for vehicle/trailer combinations.

Attach only an approved trailer hitch to your vehicle. Use only a ball neck that has been approved for your vehicle. Further information about availability and installation – including that of the trailer electrics – is available from a qualified specialist workshop.

The trailer hitch is one of the most important vehicle parts for road safety. Comply with the instructions on operation, maintenance and servicing in the manufacturer's Operator's Manual.

- ❗ Your vehicle's bumpers are not suitable for installing detachable trailer hitches.

Do not attach any rented trailer hitches or any other detachable trailer hitches to the bumpers.

- ❗ During trailer operation, remember that PARKTRONIC is available only to a limited extent, if at all.
- ❗ The height of the ball head will change depending on the vehicle's load. In this case, use a trailer with a height-adjustable drawbar.

#### Driving notes

The maximum permissible speed for vehicle/trailer combinations depends on the type of trailer. Before setting off, consult the trailer's vehicle documents to find out the maximum permissible speed.

Your vehicle will behave differently with a trailer relative to without a trailer and the high-voltage battery will need to be recharged more quickly.

Observe the notes on ESP® trailer stabilization (→ page 120).

#### Driving tips

If the trailer starts to sway, remember the following points:

- Do not accelerate under any circumstances.
- Do not countersteer.
- If necessary, apply the brakes.

- ❗ You can reduce the risk of the trailer swaying and rocking by retrofitting stabilizer bar or trailer stability programs. You can obtain further information from an authorized Mercedes-Benz Center.

When you are driving with a trailer, observe the following points:

- Maintain a greater distance from the vehicle in front than when driving without a trailer.
- Avoid braking abruptly. If possible, brake gently first of all so that the trailer closes up behind your vehicle. Then, increase the braking force rapidly.

#### Coupling/uncoupling a trailer

##### Coupling a trailer

❗ **NOTE** Damage to the starter battery due to full discharge

Charging the trailer battery using the power supply of the trailer can damage the starter battery.

- ▶ Do not use the vehicle's power supply to charge the trailer battery.

- ▶ Shift the selector lever to position **P**.
- ▶ Apply the vehicle's parking brake.
- ▶ Close all the doors.
- ▶ Position the trailer on a level surface behind the vehicle.
- ❗ The height of the ball head will change depending on the vehicle's load. In this case, use a trailer with a height-adjustable drawbar.
- ▶ Couple up the trailer.
- ▶ Establish all electrical and other connections to the trailer.
- ▶ Remove objects or devices that are preventing the trailer from rolling, e.g. chocks.
- ▶ Release the trailer's parking brake.
- ❗ The vehicle subharness has a cable connection to the brake light indicator lamp.

Observe the maximum permissible trailer dimensions (width and length).

Most US states and all Canadian provinces prescribe the following points, and you are urgently recommended to comply with these:

- Safety chains between the towing vehicle and the trailer. The chains should be routed in a criss-cross pattern under the drawbar. They must be connected to the trailer hitch and not to the bumper or to the vehicle's axle.

Leave sufficient slack in the chains. This also allows for sharp cornering.

- A separate brake system is required for certain trailers.
- A safety feature is required for braked trailers. Determine the specific requirements according to the relevant laws.

If the trailer becomes detached from the towing vehicle, the safety feature triggers the trailer brakes and can thus reduce the danger.

### Uncoupling a trailer

**⚠ WARNING** Risk of being crushed and becoming trapped when uncoupling a trailer

When uncoupling a trailer with an engaged inertia-activated brake, your hand may become trapped between the vehicle and the trailer drawbar.

- ▶ Do not uncouple trailers with an engaged overrun brake.

**! NOTE** Damage during uncoupling with an engaged overrun brake

The vehicle may be damaged if you uncouple with an engaged overrun brake.

- ▶ Do not uncouple trailers with an engaged overrun brake.

- ▶ Shift the selector lever to position **P**.
- ▶ Apply the vehicle's parking brake.
- ▶ Close all the doors.
- ▶ Apply the trailer's parking brake.
- ▶ Further secure the trailer against rolling away with a wheel chock or similar object.
- ▶ Remove the trailer cables and safety chains.
- ▶ Uncouple the trailer.

### Configuring settings for trailer operation

Multimedia system:

➤  ➤ Settings ➤ Vehicle ➤ Driving ➤ Trailer type

#### Making settings for a trailer

The settings in this menu enable the energy forecast at the start of the trip to be calculated more accurately. Thus the amount of energy, charging station scheduling, charging time and arrival time are calculated more accurately.

The selected trailer type influences:

- Navigation with Electric Intelligence
- ECO Assist
- The load spectrum

- ▶ Select the desired trailer type.
- ▶ Select the maximum permissible speed of the selected trailer.
- ▶ **To save changes:** select **Confirm**.

**i** When contact with the trailer socket is established (trailer/rear bicycle rack), a menu automatically appears on the display.

The following selections are available:

- Bicycle rack
- Small trailer
- Large trailer

#### Calibrating a trailer coupling

- ▶ Select **Trailer coupling has been changed** to start calibration for the new ball head position.
- ▶ **To save changes:** select **Confirm**.
- ▶ Activate Trailer Maneuvering Assist and follow the corresponding instructions on the central display. When the **Activated: Trailer Maneuvering Assist** message is displayed, calibration is complete and Trailer Maneuvering Assist can be used.

### Information about towing a trailer

Operating a trailer is subject to many statutory regulations such as maximum permissible speeds.

Many German states require a separate braking system for a trailer when a certain weight limit is exceeded. For your safety, it is recommended to use a separate functional braking system on any towed vehicle.

Make sure that your trailer combination meets local regulations. This not only applies to your place of residence, but also to your destination. Information on this can be obtained from the police and local authorities.

Comply with the following when driving with a trailer:

- Practice cornering, stopping and backing up in a traffic-free location. In this way, you will gain driving experience and become accustomed to the new handling characteristics.
- Before driving, check the following:
  - that the trailer hitch and ball neck are secure
  - that the safety switch for braked trailers is functioning correctly
  - that the safety chains are secure and undamaged
  - that the electrical connections are secure
  - that the lights are functioning correctly
  - the wheels for damage and correct tire pressure (→ page 190)
- Adjust the outside mirrors so that you have a clear view of the rear section of the trailer.
- If the trailer is equipped with an individual braking system, check before each journey whether the brakes are functioning correctly.
- If the trailer has electronically controlled brakes, pull away carefully with the vehicle/trailer combination. Brake manually using the brake controller and check whether the brakes are functioning correctly.
- Secure the load on the trailer in line with the requirements and rules for load-securing methods.
- When driving with a trailer, check at regular intervals that the load is secure and that the lights and brakes are functioning correctly.
- Bear in mind that the handling characteristics are more unstable when towing a trailer than when driving without a trailer. Avoid sudden steering movements.
- The vehicle/trailer combination is heavier, accelerates more slowly, has a reduced gradeability and an increased braking distance. It is more susceptible to side winds and requires careful steering.
- If possible, do not brake suddenly, but rather moderately at first so that the trailer can activate its brakes. Then increase the pressure on the brake pedal.

vate its brakes. Then increase the pressure on the brake pedal.

- Avoid constant braking, as this could cause the vehicle brakes and possibly also the trailer brakes to overheat.
  - If the coolant temperature increases significantly when the air conditioning system is switched on, switch the air conditioning system off.
- Coolant heat will also be dissipated if you switch the airflow and the temperature of the heating or air conditioning system to the maximum level. Open the windows if necessary.
- When overtaking, pay particular attention to the increased overtaking distance of your vehicle/trailer combination.

Due to the length of your vehicle/trailer combination, you will require a longer stretch of road before switching back to the original lane.

### Permissible trailer loads and tongue weights

#### Weight information

**⚠ WARNING** Risk of accident due to an unbraked trailer with an excessive gross weight

If you pull an unbraked trailer with a gross trailer weight (GTW) of more than 1,653 lbs (750 kg), the vehicle's brake system may overheat.

This increases the braking distance and may even cause the brake system to fail.

▶ Always use a trailer with a separate braking system if you are pulling a gross trailer weight (GTW) of more than 1,653 lbs (750 kg).

**! NOTE** Damage to the drive train, transmission or trailer tow hitch due to excess gross combination weight

The permissible gross combination weight is exceeded.

The drive train, the transmission or the trailer tow hitch may be damaged.

▶ Comply with the permissible gross combination weight.

In vehicles with a permissible gross vehicle weight of 11 030 lbs (5003 kg), the permissible gross combination weight is less than the sum of the per-

missible gross vehicle weight plus the permissible trailer load. If either the vehicle or the trailer is fully laden, the permitted gross vehicle weight or the permitted trailer load values will be reduced accordingly. In this case, you may only partially load the trailer or the vehicle.

The gross trailer weight (GTW) is calculated on the basis of the weight of the trailer plus the weight of its load and equipment. If the trailer is equipped with a separate braking system, then the maximum gross trailer weight is 5000 lbs (2268 kg) or 7500 lbs (3402 kg).

The maximum permissible drawbar tongue weight on the ball head is 500 lbs (227 kg) or 750 lbs (340 kg). However, the actual tongue weight must not exceed the value given on the trailer hitch or trailer identification plates. Where the values differ, the lowest shall always apply.

The gross combined weight rating (GCWR) is calculated on the basis of the gross trailer weight plus the gross vehicle weight, including a driver's weight of approximately 150 lbs (68 kg). The maximum permissible gross combination weight is vehicle-specific and equipment-dependent. When driving with a trailer, you should not exceed the maximum permissible gross combination weight rating (GCWR).

The permissible values, which must not be exceeded, can be found in your vehicle documents and on the identification plates of the trailer hitch, the trailer and the vehicle. The values approved by the manufacturer can also be found in the "Technical data" section. Where the values differ, the lowest shall always apply.

### Loading the trailer

Use a tongue weight that is as close as possible to the maximum permissible tongue weight. Do not allow the weight to fall below the minimum permissible tongue weight. Otherwise, the trailer may become detached.

- Distribute the load over the vehicle and the trailer so as not to exceed either the maximum permissible values for the gross vehicle weight rating (GVWR) and gross trailer weight (GTW), the gross combination weight rating (GCWR), or the maximum permissible gross axle weight rating (GAWR) and tongue weight (TWR) of your vehicle.
- Add the drawbar tongue weight (TWR) on the ball head to the rear axle load. This will ensure

that you do not exceed the permissible gross axle weight rating (GAWR).

- Add the vehicle load to the drawbar tongue weight (TWR) on the ball head. This will ensure that you do not exceed the permissible gross vehicle weight rating (GVWR).

### Checking vehicle and trailer weight

- Make sure that the weights of the towing vehicle and the trailer comply with the maximum permissible values. Have the vehicle/trailer combination weighed on a calibrated weighing machine. The vehicle/trailer combination comprises the towing vehicle including driver, passengers and load as well as the laden trailer.
- Check the maximum permissible gross axle weight rating of the front and rear axles (GAWR), the gross trailer weight (GTW), the gross combination weight rating (GCWR) and the drawbar tongue weight (TWR).

### Trailer power supply

Incorrect cabling of the connector plug may interfere with other electronic systems in the vehicle. Mercedes-Benz therefore recommends that you have the cabling of the connector plug carried out at a qualified specialist workshop.

You can connect accessories up to a maximum of 240 W to the permanent power supply. Do not charge a trailer battery using the power supply.

Your vehicle may be equipped with a range of electrical equipment for trailer operation. Depending on your trailer, you may need an adapter for the electrical connection between the trailer and your vehicle.

The trailer socket of your vehicle is equipped with a permanent power supply at the factory.

The permanent power supply is supplied via trailer socket pin 4.

Note that the trailer's permanent power supply is not switched off when the vehicle's on-board electrical system voltage is low. This could completely discharge your vehicle's starter battery.

Further information on the electrical equipment currently installed on your vehicle and on installing the trailer electrics can be obtained at a qualified specialist workshop.

## Overview of the instrument cluster

**⚠ WARNING** Risk of accident due to an instrument cluster malfunction

In the event of a failure or malfunction of the instrument cluster, you will not recognize limitations in the functions of systems relevant to safety. This may impair operating safety.

▶ Park the vehicle safely as soon as possible and notify a qualified specialist workshop.

If you are uncertain regarding the operational safety of your vehicle, park the vehicle safely as soon as possible. Inform a qualified specialist workshop.

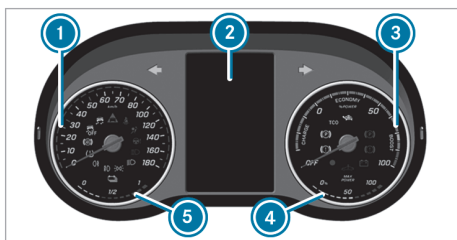

- ① Speedometer
- ② Instrument cluster display (→ page 139)
- ③ Power availability display (→ page 137)
- ④ Maximum available output of the drive system
- ⑤  State of charge of the high-voltage battery (→ page 252)

## Function of the power availability display

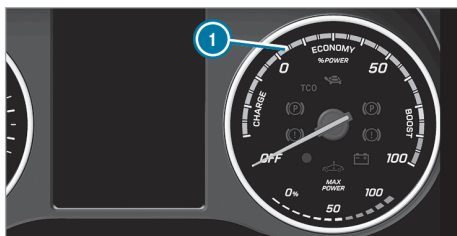

Power availability display (example)

The power availability display ① includes two areas:

- In the area below **0**, the recovered power of the vehicle during recuperation is displayed.
- In the area above **0**, the current amount of power that the drive system is feeding to the wheels is displayed.

If the needle for the power availability display is in the **OFF** position, the vehicle is not ready to drive.

The vehicle is not ready to drive in the following situations:

- The drive system has not yet started.
- There is still a charging cable connected to the vehicle socket.
- There is insufficient high-voltage battery power available.
- There is a malfunction in the high-voltage on-board electrical system.









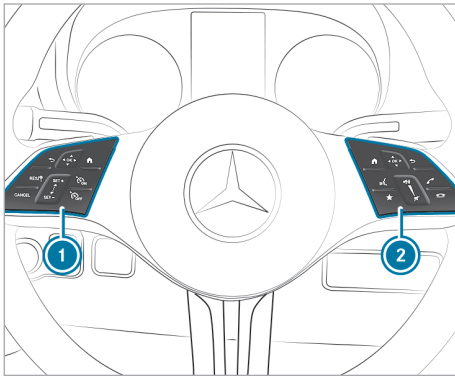







Once the vehicle is ready to drive, the needle moves to the **0** position and the display **READY** appears on the instrument cluster.

The braking effect of the electric motor using recuperation is either reduced or not effective in the following operating statuses:

- The high-voltage battery is not yet at normal operating temperature.
- The road speed is close to vehicle standstill.
- The transmission is in position **N**.
- During or after an ESP<sup>®</sup> control intervention.

Overview of the buttons on the steering wheel



- 
  -  Calls up the main menu.
  -  Confirms a selection/hides display messages
  -  Swipe in the direction of the arrow (navigate).
  -  Back
  -  Activates cruise control.
  -  Deactivates cruise control.
  -  Operates cruise control.
- 
  -  Calls up the main menu.
  -  Confirms a selection/hides display messages
  -  Swipe in the direction of the arrow (navigate).
  -  Back
  -  Makes or accepts calls/switches to the redial memory
  -  Ends or declines calls/exits the phone book or redial memory.
  -  Press to switch off the sound.
  - To increase volume: swipe upwards.
  - To reduce volume: swipe down.
  -  To call up favourites: press briefly.

To add favourites and themes: press and hold.  
 Activates Voice Control System.



Overview and operation of the on-board computer

**⚠ WARNING** Risk of distraction from information systems and communications equipment

If you operate information systems and communication devices integrated in the vehicle when driving, you could be distracted from the traffic situation. This could also cause you to lose control of the vehicle.

- ▶ Only operate this equipment when the traffic situation permits.
- ▶ If you cannot be sure of this, stop the vehicle whilst paying attention to road and traffic conditions and operate the equipment with the vehicle stationary.

You must observe the legal requirements for the country in which you are currently driving when operating the on-board computer.

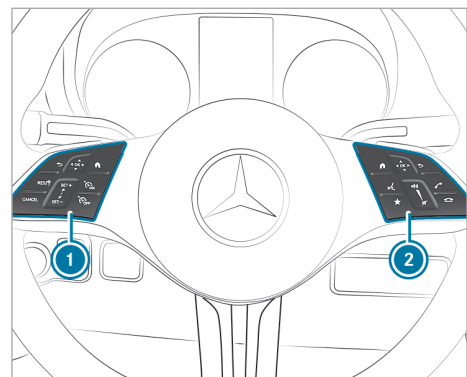











- ① Left-hand steering wheel control panel
- ② Right-hand steering wheel control panel

When you switch the power supply on, the on-board computer will be activated.



You can control the displays and the settings on the on-board computer using the buttons on the left- ① and right-hand ② steering wheel control panels.







## Steering-wheel buttons

## Left-hand steering wheel control panel

	<ul style="list-style-type: none"> <li>Call up the main menu</li> </ul>
	<p><b>Swipe in the direction of the arrow</b></p> <ul style="list-style-type: none"> <li>Scroll through lists</li> <li>Select menu or function</li> <li>In the <b>Radio</b> or <b>Media</b> menu, open the track or station list and select a station, audio track or video scene.</li> <li>On the <b>Phone</b> menu, switch to the telephone book and select a name or a telephone number.</li> </ul>
	<p><b>Swipe in the direction of the arrow</b></p> <ul style="list-style-type: none"> <li>Quickly scroll through all lists</li> <li>In the <b>Radio</b> or <b>Media</b> menu, use rapid scroll to select a station, audio track or video scene.</li> <li>On the <b>Phone</b> menu with the telephone book open, start rapid scroll.</li> </ul>
	<ul style="list-style-type: none"> <li>Activates cruise control</li> </ul>
	<ul style="list-style-type: none"> <li>Deactivates cruise control</li> </ul>
	<ul style="list-style-type: none"> <li>Operates cruise control</li> </ul>
	<ul style="list-style-type: none"> <li>Increases the selected value</li> </ul>
	<ul style="list-style-type: none"> <li>Decreases the selected value</li> </ul>
	<ul style="list-style-type: none"> <li>Discards the current settings</li> </ul>
	<ul style="list-style-type: none"> <li>Back button, left (on-board computer)</li> </ul>

## Right-hand steering wheel control panel on the steering wheel

	<ul style="list-style-type: none"> <li>Call up the main menu</li> </ul>
	<p><b>Swipe in the direction of the arrow</b></p> <ul style="list-style-type: none"> <li>Scroll through lists</li> <li>Select menu or function</li> <li>In the <b>Radio</b> or <b>Media</b> menu, open the track or station list and select a station, audio track or video scene.</li> <li>On the <b>Phone</b> menu, switch to the telephone book and select a name or a telephone number.</li> </ul>

	<p><b>Swipe in the direction of the arrow</b></p> <ul style="list-style-type: none"> <li>Quickly scroll through all lists</li> <li>In the <b>Radio</b> or <b>Media</b> menu, use rapid scroll to select a station, audio track or video scene.</li> <li>On the <b>Phone</b> menu with the telephone book open, start rapid scroll.</li> </ul>
	<ul style="list-style-type: none"> <li>Make or accept a call</li> <li>Switch to the redial memory</li> </ul>
	<ul style="list-style-type: none"> <li>Reject or end a call</li> <li>Exit the telephone book or redial memory</li> </ul>
	<ul style="list-style-type: none"> <li>Selects voice control</li> </ul>
	<ul style="list-style-type: none"> <li>Displays favorites (multimedia system)</li> </ul>
	<ul style="list-style-type: none"> <li>Increases/decreases volume or turns off sound</li> </ul>
	<ul style="list-style-type: none"> <li>Back button, right (multimedia system)</li> </ul>

## Overview of instrument cluster display

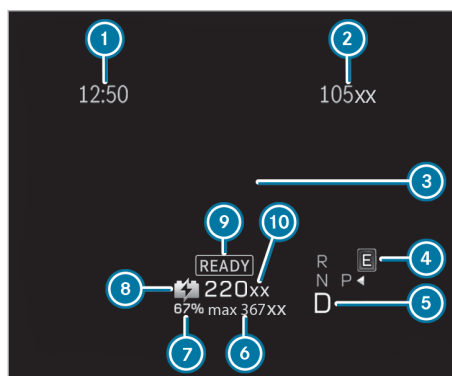

Messages on the display of the instrument cluster (example)

- ① Time
- ② Outside temperature
- ③ Display section menu (→ page 141)
- ④ Drive program (→ page 104)
- ⑤ Drive range (→ page 104) and recuperation display (→ page 95)
- ⑥ Maximum possible range

- ⑦ State of charge in % (→ page 140)
- ⑧ Charging active
- ⑨ **READY** display (→ page 97)
- ⑩ Current range, depending on driving style and electrical consumers

### Function of the charge level display

Percentage ⑦ (→ page 139) indicates the state of charge of the high-voltage battery. In addition, the maximum range is displayed beside it and the current range is displayed above it.

When the drive system is ready for operation **READY** and the **Reserve Level Charge High-Voltage Battery** message appears or the  indicator lamp on the instrument cluster lights up, the state of charge of the high-voltage battery has reached the reserve level.

You can find information about charging the high-voltage battery in the section "Charging the high-voltage battery" (→ page 106).

### Display of the available power

**⚠ WARNING** Risk of accident due to reduced power of the drive system

If the drive system experiences a power output limitation, there is a risk of accident, particularly when accelerating and overtaking.

- ▶ Adapt your driving style and drive particularly carefully.
- ▶ Charge the high-voltage battery at a charging station immediately.



Display of the maximum available power

In the following operating conditions, the available power may be reduced:

- in very high or low outside temperatures
- if there are very high power requirements over an extended period of time

- if the state of charge of the high-voltage battery is very low
- if there is a malfunction in the drive system

You can improve the reduced power availability by charging the high-voltage battery (→ page 106).

### Warnings in the event of low output

If the drive system had been exposed to very low temperatures, the instrument cluster may show the following warnings once the vehicle has been started:



Displays when drive power is low (example values)

- ① Alternating display: **Reduced Drive System Performance See Operator's Manual and Reserve Level Charge High-Voltage Battery**
- ② Maximum range shows xxx miles (xxx km)
- ③ Current range shows xxx miles (xxx km)
- ④ State of charge of the high-voltage battery in % appears in yellow
- ⑤ High-voltage battery indicator lamp lights up yellow

A warning tone also sounds.

Only around 30 % of the usual drive power is available.

In this case, do not switch on the  windshield defrosting climate control function. Otherwise, the output will decline further.

Charge the high-voltage battery.



### Adjusting the instrument lighting

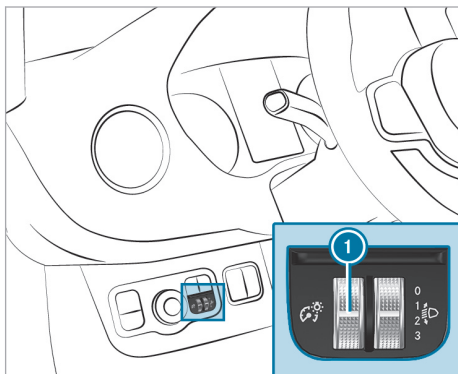

- ▶ Turn brightness control ❶ upwards or downwards. The lighting of the instrument cluster and the controls in the vehicle interior will be adjusted.
- ❶ In vehicles without brightness control ❶, the instrument lighting can be adjusted via the on-board computer (→ page 143).

### Menus and submenus

#### Calling up functions on the service menu

On-board computer:

→ Service

- ▶ Select and confirm the desired function.

The following functions are available on the service menu:

- **Announcements:** message memory (→ page 227)
- **Tires:**
  - checking the tire pressure with the tire pressure monitoring system (→ page 196)
  - restarting the tire pressure monitoring system (→ page 196)
- **ASSYST PLUS:** calling up the service due date (→ page 168)

### Calling up the assistant display

On-board computer:

→ Service

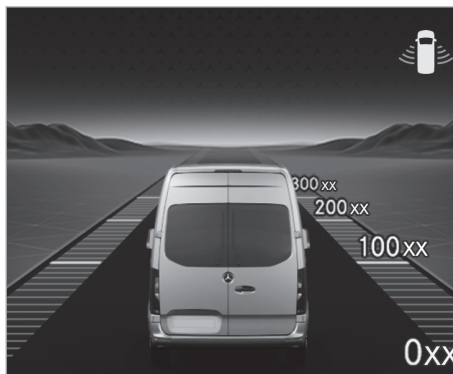

The following displays are available on the Assistance menu:

- Assistant display



Instrument cluster display

The following status displays are available on the assistant display:

- Lane markings solid and thick: Lane Keeping Assist on and ready to issue warnings
- Lane markings solid and thin: Lane Keeping Assist on and not ready to issue warnings
- Lane markings dotted: Lane Keeping Assist off
-  Blind Spot Assist on and ready to issue warnings (lines of the radio waves green)
-  Blind Spot Assist on and not ready to issue warnings (lines of the radio waves gray)
-  Blind Spot Assist off

### Calling up displays on the Trip menu

On-board computer:

→ Trip

- ▶ Select the desired display and confirm.

The following displays are available on the trip menu:

- Standard display
- **Current Consumption**
- **Range**
- **ECO Display**
- **ATTENTION ASSIST**

- Trip computer:
  - From Start
  - From Reset
- Digital speedometer



Standard display (example)

- 1 Trip distance
- 2 Distance unit
- 3 Total distance
- 4 Charging prediction at departure time (only when charging is active and the vehicle is not in **READY** status)

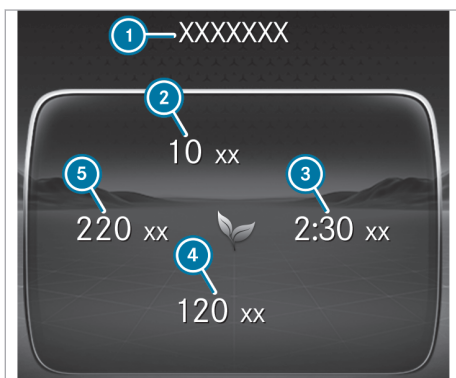

Trip computer display (example)

- 1 From start or from reset
- 2 Average energy consumption (from start or from reset)
- 3 Driving time (from start or from reset)
- 4 Average speed (from start or from reset)
- 5 Distance covered (from start or from reset)



ATTENTION ASSIST display: break in less than 15 mins

### Resetting values on the trip menu of the on-board computer

On-board computer:



- The wording may differ on the main menu displayed. Therefore, pay attention to the menu overview for the instrument cluster (→ page 138).

You can reset the values of the following functions:

- Trip Odometer:
  - Reset Trip Odometer?
- Trip computer:
  - From Start
  - From Reset
- ECO Display
- Current Consumption
- Range
  - Reset range
- ATTENTION ASSIST

- ▶ Select the function for which the value is to be reset and confirm this selection.
- ▶ Confirm the prompt **Reset Values?** with **Yes**.

### Calling up the battery calibration menu

On-board computer:

- ▶ Settings ▶ eSprinter
- ▶ Battery Calibration

The menu indicates whether the high-voltage battery needs to be calibrated.

- ▶ Observe the notes on calibrating the high-voltage battery (→ page 168).
- ▶ Confirm the selection of **Perform Calibration** and carry out a normal or a special calibration (→ page 169).

or

- ▶ Exit the menu without confirming.

### Calling up settings on the on-board computer

On-board computer:

↳ **Settings**

The following entries can be configured on the **Settings** menu:

eSprinter

- Carrying out **Battery Calibration**
- ▶ Select an entry and confirm the selection.
  - ▶ Make the necessary changes.

## Mercedes me calls

### Making a call via the overhead control panel

- ① Mercedes me calls are not possible in every country. Contact an authorized Mercedes-Benz Center to find out whether these functions are available in your country.
- ① Please note that product scopes can vary depending on the model series, year of production and equipment, as well as between private and commercial user accounts.

The following services have no limitation in the term:

- Accident and Breakdown Management
- Maintenance management
- Telediagnosics

Other services can be extended at the end of the initial term for a fee. The first activation of the services by the customer is possible within one year of initial registration or commissioning, depending on which happens first.

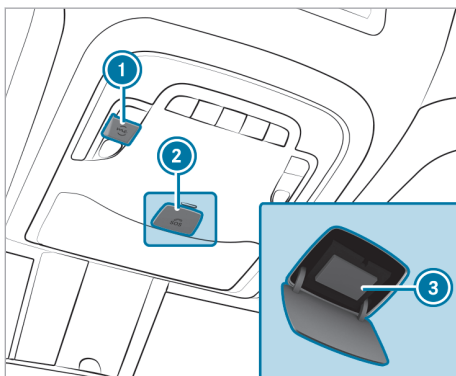



- ① me button for service or information calls
- ② SOS button cover
- ③ SOS button (emergency call system)

### Making a Mercedes me call

- ▶ Press button ①.

### Making an emergency call

- ▶ Briefly press the cover on  button ② to open it.
- ▶ Press and hold  button ③ for at least one second.

An emergency call can still be triggered when a breakdown assistance call is active. This has priority over all other active calls.

### Information about the Mercedes me call using the overhead control panel

A call to the Mercedes-Benz Customer Center was initiated using the me button in the overhead control panel (→ page 144).

You can reach the desired service via the voice dialog system:

- Accident and Breakdown Management
- Mercedes-Benz Customer Center for general information about the vehicle

You can find information on the following topics:

- Activation of Mercedes me connect
- Operating the vehicle
- Nearest authorized Mercedes-Benz Center
- Other products and services from Mercedes-Benz

Data is transmitted during the connection to the Mercedes-Benz Customer Center (→ page 145).

### Calling the Mercedes-Benz Customer Center using the multimedia system

#### Requirements:

- Access to a GSM network is available
- The contract partner's GSM network coverage is available in the respective region
- The vehicle must be switched on so that vehicle data can be transferred automatically.

Multimedia system:



- ▶ Call **Mercedes me connect**.

With your consent, the multimedia system sends the required vehicle data. The data transfer is shown in the display.

Then, you can select a service and be connected to a contact at the Mercedes-Benz Customer Center.

### Arranging a service appointment via Mercedes me call

If you have activated the maintenance management service, relevant vehicle data is transferred automatically to the Mercedes-Benz customer cen-

ter. You will then receive individual recommendations regarding the maintenance of your vehicle. You will receive an offer for the upcoming maintenance scopes from the service partner stored in Mercedes me.

Regardless of whether you have consented to the maintenance management service, the multimedia system reminds you after a certain amount of time that a service is due. A prompt appears asking if you would like to make an appointment.

► **To arrange a service appointment:** select **Call**. After your confirmation, the vehicle data is sent and the Mercedes-Benz customer center deals with your appointment. The information is then sent to your desired service outlet.

This will contact you to confirm the appointment and if necessary consult about the details.

- ❗ If you select **Call Later** after the service message appears, the message is hidden and reappears at a later time.
- ❗ No request for consent to data transfer is made, if the Mercedes me connect Accident and Breakdown Management service is activated.

### Consenting to data transfer for a Mercedes me call

#### Requirements:

#### Transferred data during a Mercedes me call

When you make a service call via Mercedes me, data is transmitted. This enables targeted advice and smooth service.

The following requirements must be met for the data transfer:

- The vehicle is switched on.
- The necessary data transmission technology is supported by the mobile phone network provider.
- A sufficient mobile phone connection quality is provided.

Multi-stage transmission depends on the following factors:

- Reason for the initiation of the call
- Available mobile radio transmission technology
- Activated Mercedes me connect services
- Selected service in the voice dialog system

- ❗ A request for consent to data transfer is only made if the corresponding Mercedes me connect service has not been activated.
- ❗ The scope of the transmitted data depends on the vehicle model and equipment. For technical reasons not all data is available at all times.
- ❗ The prompt to confirm data transfer does not appear in all countries.

#### **Data transfer when Mercedes me connect services are not activated**

If no Mercedes me connect services are activated and the data protection query has been confirmed, the following data will be transferred:

- Vehicle identification number
- Time of the call
- Reason for the initiation of the call
- Confirmation of the data protection prompt
- Vehicle country code
- Set language for the multimedia system
- Call number of the communication platform installed in the vehicle

If a call is made for a service appointment via the service reminder, the following data is also transmitted:

- Current mileage and maintenance data

If a call was made via the multimedia system after automatic accident or breakdown detection, the following data is also transmitted:

- Current mileage and maintenance data
  - Estimated number of people in the vehicle
- The detection is based on the number of closed seat belt buckles on the front seats.

If the Accident and Breakdown Management selection has been made via the voice dialog system and no service has been activated, but the data protection query has been confirmed, the following data can be additionally requested from the vehicle by the Mercedes-Benz Customer Center:

- Current vehicle location

If the data protection request has been declined, the following data will be transferred to enable targeted advice and a smooth service:

- Reason for the initiation of the call
- Rejection of the data protection prompt
- Vehicle country code

- Set language for the multimedia system
- Call number of the communication platform installed in the vehicle

### Data transfer when Mercedes me connect services are activated

Only in the second step, only for the respective activated services, further case-specific data is transmitted in order to enable an optimal service.

An overview of the data transmitted can be found in the respective terms of use for Mercedes me connect services. You can obtain these in the Mercedes me Portal at: <https://www.mercedes.me>

### Data processing

The data transmitted as part of the call will be deleted from the transmitting systems once the call has been completed, provided they are not used for other activated Mercedes me connect services.

The case-related data will be processed and stored in the Mercedes-Benz Customer Center and, if necessary for case processing, forwarded to the service partners commissioned by the Mercedes-Benz Customer Center. Please refer to the data protection information on the Mercedes me website at <https://www.mercedes.me> or in the recorded message immediately after the call to the Mercedes-Benz Customer Center has been set up.

- ⓘ The recorded message is not available in every country.

## Mercedes me connect

### Information about Mercedes me connect

- ⓘ Please note that product scopes can vary depending on the model series, year of production and equipment, as well as between private and commercial user accounts.

Mercedes me connect comprises a number of services.

Using the multimedia system or the overhead control panel, if available, you can use the following services, for example:

- Accident and breakdown management (me button)
- Emergency Call System (automatic emergency call and SOS button)

Mercedes me connect Accident and Breakdown Management and the Mercedes-Benz Emergency Call System are available to you around the clock.

The me button and the SOS button can be found on the vehicle's overhead control panel (→ page 144).

If the multimedia system is available in the vehicle, you can also call the Mercedes-Benz customer center using the multimedia system (→ page 144).

Please note that Mercedes me connect is a Mercedes-Benz service. In emergencies, call the national emergency services first using the standard national emergency service phone numbers. In emergencies, you can also use the emergency call system (→ page 179).

Please note the Mercedes me connect terms of use and the data protection information for Mercedes me connect. You can find these in your Mercedes me user account.

Further information about Mercedes me connect services can be obtained in the Mercedes me Portal: <https://me.secure.mercedes-benz.com>

### Information on Mercedes me connect Accident and Breakdown Management

- ⓘ Accident and Breakdown Management is not available in every country. Contact an authorized Mercedes-Benz Center to find out whether this function is available in your country.

The Accident and Breakdown Management can, amongst others, include the following functions:

- Supplement to the Emergency Call System (→ page 179)

If necessary, the contact person at the Mercedes-Benz emergency call center forwards the call to Mercedes me connect Accident and Breakdown Management. However, call forwarding is not possible in all countries.

- Breakdown assistance on location by a technician and/or towing away of the vehicle to the nearest authorized Mercedes-Benz Center  
You may be charged for these services.
- In the event of a breakdown or accident, extended vehicle data is sent, enabling optimum support from the Mercedes-Benz Customer Center and the appointed service partner or breakdown mechanic.
- If available: addition to the Mercedes me connect Telediagnosics service

With the Telediagnosics function, the service provider records certain wear and failure mes-

sages, insofar as these can be clearly interpreted and are available by monitoring diagnosable components.

If your vehicle detects a breakdown or impending breakdown, you may be prompted via the multimedia system to contact the Mercedes-Benz Customer Center for further assistance. This prompt in the multimedia system only appears when the vehicle is stationary.

- ❗ These services are subject to technical restrictions such as mobile coverage and mobile network quality and the interpretability of the transmitted data in the processing systems. Under certain circumstances, this may result in delays or omission of the message in the multimedia system.

Please note that the Mercedes me call is a Mercedes-Benz service. In the event of an emergency always call the national emergency services first or use the Mercedes-Benz emergency call system (→ page 179).

Further information about Mercedes me connect services can be obtained in the Mercedes me Portal: <https://me.secure.mercedes-benz.com>

### Data transferred during Mercedes me connect call services

The data transferred during the Mercedes me connect call depends on:

- The reason for the initiation of the call
- The service selected in the voice dialog system
- The activated Mercedes me connect services

The data which is transferred is listed in the currently valid terms of use and data protection information of Mercedes me connect. These can be found at: <https://www.mercedes.me> under "My Mercedes me account", "Terms of use".

## Mercedes me and apps

### Information about Mercedes me

#### Requirements:

- To use the services, registration in the Mercedes me Portal must have been carried out.
- The terms of use for Mercedes me connect services have been agreed to.
- The services are activated.

The services can be activated in the Mercedes me Portal via the path **Manage vehicle > My services**.

When you log in with a user account to the Mercedes me Portal, then services and offers from Mercedes-Benz will be available to you.

- ❗ Please note that product scopes can vary depending on the model series, year of production and equipment, as well as between private and commercial user accounts.

Availability is country-dependent.

For more information consult an authorized Mercedes-Benz Center or visit the Mercedes me Portal: <https://me.secure.mercedes-benz.com>.

- ❗ Make sure that you always keep the Mercedes me Apps up to date.

### Calling up a Mercedes me user account

Multimedia system:

→  >> Apps >> Mercedes me

### Vehicle is linked to a user account and Mercedes me is available

- ▶ Select **Mercedes me ID**.  
Information about the linked user account appears.

### Your vehicle is not linked to the user account

- ❗ If you do not yet have a Mercedes me user account, you can create one at: <https://www.mercedes.me> or in the Mercedes me App. A valid email address or phone number is required for this.

- ▶ Select  .
- ▶ Select **Apps**.
- ▶ Select **Mercedes me**.
- ▶ Follow the instructions on the display to link your user account with the vehicle.

- ❗ If the Mercedes me App is available on a mobile phone, the vehicle link can be made via the displayed QR code.

### Calling up Mercedes me services

---

**Requirements:**

- The vehicle is connected with the user account.

Multimedia system:

↳  >> Apps >> Mercedes me

▶ Select **My Services**.

The Mercedes me connect services for which you have a valid license are displayed in alphabetical order.

### Ordering or renewing Mercedes me connect services

To order or renew Mercedes me connect services, use the Store.

▶ Select .

▶ Select **Store**.

### Removing the link between the user account and the vehicle

---

**Requirements:**

- The user profile of the user account that was first linked to the vehicle is selected.
- The user profile is synchronized .
- A Mercedes me PIN has been set.

Multimedia system:

↳  >> Apps >> Mercedes me

▶ Select **Mercedes me ID**.

▶ Select **Delete vehicle connection**.

ⓘ Only the user whose user account was linked to the vehicle first can remove the link between all user accounts and the vehicle.



## Overview and operation

### Notes on MBUX multimedia system

**⚠ WARNING** Risk of distraction from information systems and communications equipment

If you operate information systems and communication devices integrated in the vehicle when driving, you could be distracted from the traffic situation. This could also cause you to lose control of the vehicle.

- ▶ Only operate this equipment when the traffic situation permits.
- ▶ If you cannot be sure of this, stop the vehicle whilst paying attention to road and traffic conditions and operate the equipment with the vehicle stationary.

You must observe the legal requirements for the country in which you are currently driving when operating the multimedia system. Depending on the equipment, the range of functions and product designation of your MBUX multimedia system may differ from the description and illustrations in the Operator's Manual.

MBUX stands for Mercedes-Benz User Experience.

### Overview of the MBUX multimedia system

**i** The functions of your MBUX multimedia system may differ and depend on the following factors:

- Market
- National version
- Technical conditions

Functions, services and service aspects provided by Mercedes-Benz and/or third-party providers may no longer be available when the contractual period expires or due to technical conditions. There is therefore no entitlement to the continuous provision of functions and services.

The described functions may be modified, optimized and adapted after the time of going to press.

Mercedes-Benz therefore reserves the right to introduce changes in the following areas:

- Features
- Services
- Service aspects

For these reasons, descriptions and depictions relating to the MBUX multimedia system may, in some cases, differ for your vehicle.

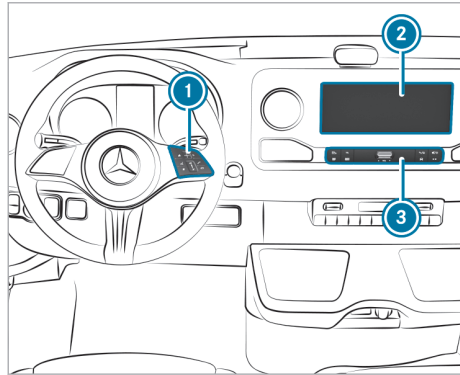

- ① Touch Control and multimedia system control panel
- ② Media display with touch functionality
- ③ Operating strip, calls up applications

A multimedia connection unit is located beneath the gearshift lever and has two type C USB ports .

You can operate the multimedia system with the following central control elements:

- Touch Control ①
- Media display (touchscreen) ②
- Buttons on operating strip ③

**i** Alternatively, you can carry out a spoken dialog with the MBUX Voice Assistant .

**i** You can find further information about operation as well as about applications and services in the Digital Operator's Manual.

### Anti-theft protection

This device is equipped with technical provisions to protect it against theft. Further information on anti-theft protection can be obtained at an authorized Mercedes-Benz Center.

Home screen overview

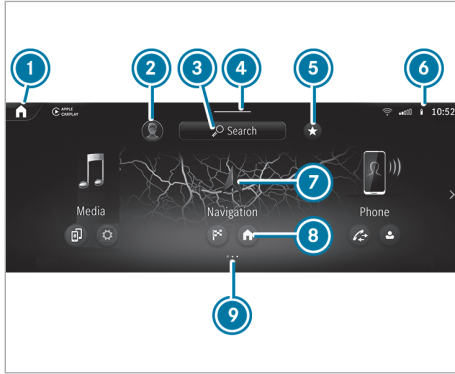

- ① On the home screen: displays the first three applications  
In other displays: calls up the home screen
- ② Calls up user profile settings and switches user
- ③ Uses the global search
- ④ Calls up the Control Center: pull the bar down
- ⑤ Calls up favorites
- ⑥ Displays in the status line
- ⑦ Calls up an application
- ⑧ Quick-access to application
- ⑨ Index points for selected display area

The following functions are called up in the Control Center:

- Notifications Center
- Favorites
- Vehicle quick-access

Operating the MBUX multimedia system

Using Touch Control

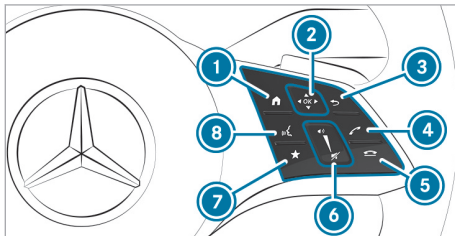

- ① Shows the home screen
- ② Touch Control

Swipe in the direction of the arrow (navigate)

Press (confirm)

③ Returns to the previous display

④ Makes or accepts a call

⑤ Rejects or ends a call

⑥ To increase volume: swipe upwards

To reduce volume: swipe down

To switch off the sound: press

⑦ Calls up favorites

⑧ Starts the MBUX Voice Assistant

⑨ To operate Touch Control ② in the most effective way, use the tip of your thumb if possible.

You can navigate through menus and lists via the touch-sensitive surface of Touch Control ② using a **single-finger swipe**, e.g.:

▶ **To enter a character:** select a character using the keyboard and press on Touch Control ②.

▶ **To select a menu option:** scroll in a list and press Touch Control ②.

▶ **To move the digital map:** swipe in any direction.

Using the touchscreen

▶ **To select a menu item or entry:** tap on a symbol or an entry.

▶ **To increase the map scale:** tap twice quickly with one finger.

▶ **To reduce the map scale:** tap with two fingers.

▶ **To enter characters with the keyboard:** tap on a button.

▶ **To navigate in menus:** swipe up, down, left or right.

▶ **To use handwriting to enter characters:** write the character with one finger on the touchscreen.

▶ **To zoom in and out of the map:** move two fingers together or apart.

▶ **To enlarge or reduce the size of a section of a website:** move two fingers together or apart.

▶ **To turn the digital map:** turn counter-clockwise or clockwise using two fingers.

▶ **To move the digital map:** touch the touchscreen and move your finger in any direction.

- ▶ **To save the destination in the digital map:** touch the touchscreen and hold until a message is shown.
- ▶ **To set the volume on a scale:** touch the touchscreen and move the finger to the left or right.
- ▶ **To call up a global menu in the applications:** touch the touchscreen and hold until the **Options** menu appears.

#### Calling up applications using a button

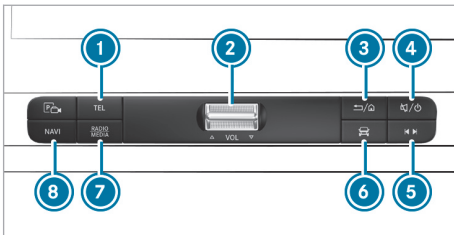

- ① **TEL** button  
Calls up the telephone
  - ② Volume rocker switch  
Adjusts the volume
  - ③ button  
Press briefly: returns to the previous display  
Press and hold: calls up the home screen
  - ④ button  
Press briefly: switches sound off  
Press and hold: activates or deactivates the multimedia system
  - ⑤ Quick-access button for media  
Calls up the control menu of the last active media source
  - ⑥ Vehicle button  
Sets vehicle functions
  - ⑦ **RADIO MEDIA** button  
Pressing repeatedly calls up the desired audio source
  - ⑧ **NAVI** button  
Calls up navigation
- ▶ **To access stations and music tracks quickly:** press button ⑤.  
The control menu appears for the audio source that was last selected.
  - ▶ Swipe to the left or right.  
Radio: the previous or next station is set.  
Media source: the previous or the next music track is selected.

#### Function of the MBUX Voice Assistant

**⚠ WARNING** Risk of distraction from information systems and communications equipment

If you operate information systems and communication devices integrated in the vehicle when driving, you could be distracted from the traffic situation. This could also cause you to lose control of the vehicle.

- ▶ Only operate this equipment when the traffic situation permits.
- ▶ If you cannot be sure of this, stop the vehicle whilst paying attention to road and traffic conditions and operate the equipment with the vehicle stationary.

For your own safety, always observe the following points when operating mobile communications equipment and especially your voice control system:

- Please observe the legal requirements for the country in which you are driving.
- If you use the voice control system in an emergency your voice can change and your telephone call, e.g. an emergency call, can thereby be delayed.
- Familiarize yourself with the voice control system functions before starting the journey.

Using the MBUX Voice Assistant, vehicle functions and various areas of the MBUX multimedia system can be operated by voice input. The MBUX Voice Assistant is operational approximately half a minute after switching on the vehicle and can be operated from all seats. Further information and examples of voice commands can be found in the Digital Operating Instructions.

You can use the MBUX Voice Assistant to operate the following functions depending on the vehicle equipment:

- Telephone
- Text message and e-mail
- Navigation
- Radio and media
- Vehicle functions
- Online functions

Full functionality of the voice control system is only available for you with activation of online voice control.

## Conducting a dialog

### Starting a dialog

- ▶ Say "Hey Mercedes" to activate the MBUX Voice Assistant. Voice activation must be switched on in the multimedia system.

or

- ▶ Press the  button on the multifunction steering wheel.

A blue line appears in the MBUX multimedia system. The dialog can be started.

For the dialog with the MBUX Voice Assistant, you can use complete sentences of colloquial language as voice commands. Voice activation can also be directly combined with a voice command, e.g. "Hey Mercedes, how fast can I drive?"

### Calling up help

- ▶ **For information about the MBUX Voice Assistant:** say "Hey Mercedes, what can you do?"
- ▶ **Digital Operating Instructions:** "Show me the Operating Instructions". The full extent of the Digital Operating Instructions is available when the vehicle is stationary.

### Operating functions (examples)

- ▶ **To operate the navigation:** "Search for an Asian restaurant, but not Japanese, in South Manhattan."
- ▶ **To operate the phone:** "Call my father."
- ▶ **To change the system language to English (short command):** "Change language to English".
- ▶ **To operate the radio:** "Show me the list of radio stations."
- ▶ **To operate media:** "Switch on random playback."
- ▶ **To operate vehicle functions:** "Switch the seat heating to level 2."
- ▶ **To operate online functions:** "What's the time in Sydney?"
- ▶ **To ask a question about the vehicle:** "Do I have Blind Spot Assist?"

## Information on users, suggestions and favorites

**⚠ WARNING** Risk of becoming trapped during adjustment of the driver's seat after calling up a driver profile

Selecting a user profile may trigger an adjustment of the driver's seat to the position saved under the user profile. You or other vehicle occupants could be injured in the process.

- ▶ Make sure that when the position of driver's seat is being adjusted using the multimedia system, no people or body parts are in the seat's range of movement.

If there is a risk of someone becoming trapped, immediately stop the adjustment process by:

- ▶ a) Pressing the warning message on the central display.

or

- ▶ b) Pressing a position button of the memory function or a seat adjustment switch in the driver's door.  
The adjustment process is stopped.

The driver's seat is equipped with an anti-entrapment feature.

If the driver's door is open, the driver's seat will **not** be set after calling up the driver's profile.

### User profiles and user-specific content

Prerequisites for the vehicle owner:

- You have a Mercedes me user account.
- You have a Mercedes me PIN.
- You have agreed to the terms of use.
- The vehicle is connected to a Mercedes me user account.

- ⓘ If one of the pre-requisites listed is missing or if no user profile has been selected, the data described in the following section will be saved in the vehicle as the standard setting. Standard settings can be changed by all vehicle users.

User profiles save personal settings. If the vehicle is used by several people, a person can change their profile settings without changing the settings of other users.

You can individualize a user profile in the vehicle using the set-up assistant or using the settings in your user profile. Some settings, e.g. the Mercedes

me PIN and a profile photo are made in the Mercedes me App or in the Mercedes me Portal. User-specific content and applications with personal data are protected by different levels of security. To access protected content, the Mercedes me PIN and, depending on the vehicle equipment, biometric sensors can be used.

- ❶ The security level is set by the multimedia system and calculated from the combination of all sensor inputs. Some security levels cannot be turned off.
- ❷ When a user profile is activated, the following personalized comfort systems, for example, can be adjusted or their settings loaded:
  - Seat
  - Outside mirrors
  - Climate control settings

If the user profile is activated when driving, the driver's seat position will not be adjusted.

Depending on the vehicle equipment you can, as a user, save the following settings, for example:

- Driver's seat, steering wheel and mirror settings
- Climate control
- Ambient lighting
- Radio (including station list)
- Suggestions and favorites

### Suggestions

The vehicle can learn the habits of the driver. It then makes suggestions regarding navigation destinations, phone numbers and music preferences. The requirements for that are the selection of a user, your consent to the recording of data and sufficient collected data.

### Favorites

Favorites offer you quick access to frequently used applications. 100 favorites are available in total.

## Configuring users, suggestions and favorites

### Requirements:

- The vehicle is stationary.

Multimedia system:

 **Select User**

### Adding a user

- ▶ Select  **Add User** .  
A QR code is loaded.

- ▶ Scan the displayed QR code with the Mercedes me App or any QR code scanner on a mobile device. If the Mercedes me App is not yet installed on your mobile device, you will be directed to the store of your mobile device.
- ▶ Follow the directions in the app. The vehicle is connected with your Mercedes me user account. This automatically creates your user profile in the vehicle. You will be informed when your user profile is available. When the vehicle is stationary, the set-up assistant starts automatically after user selection.

### Protecting user-specific content and applications

If you add a new user, access protection is already activated for the user profile. The Mercedes me PIN and, depending on the vehicle equipment, biometric sensors are available for access. Biometric sensors in the vehicle must be taught in. The authentication process then takes all taught-in and available sensors into account.

The following user-specific content and applications are protected, for example:

- User selection and user profile settings
- Biometric sensors  
The teaching-in of biometric sensors is protected.
- Suggestions  
The data and determination of the most probable navigation destinations, media sources, radio stations, contacts and messages are protected.
- Mercedes me connect store  
The purchase of services is protected.

- ▶ Switch **Protect Content** on or off.

- ▶ Switch **Access Protection** on or off.

- ❶ When access protection is switched off, your user profile can be viewed from any seat and changes can be made.
- ❷ Access protection is switched on or off on a vehicle-specific basis.

### Setting up, editing and deleting biometric recognition

The biometric data models are saved in the sensors in the vehicle. If recognition has been taught-in, this sensor serves as a contributory factor for authentication on the multimedia system.

- ▶ Select **Protect Content**.
- ▶ Select **Voice Recognition**.
- ① If necessary, authenticate yourself on the multimedia system.

### Setting up voice recognition

- ▶ Speak the sentence shown on the media display and follow the voice assistant's instructions.  
If voice recognition was successful, a message appears on the media display. You can unlock your user profile.
- ① Avoid background or disturbing noises during voice recognition.



### Deleting biometric data

- ▶ Tap on  behind **Voice Recognition**.
- ▶ Select **Yes**.

### Selecting a user

- ① When you call up your driver profile, the driver's seat and the steering wheel can be set.  
You can cancel the setting process with the following actions:
  - Tap on the **Tap Here to Cancel** message on the media display.
  - Press one of the seat operating buttons in the driver's door.
- ▶ Select **Select User**.
- ▶ Select a user.
- ▶ When requested to do so, authenticate with the Mercedes me PIN or a taught-in biometric characteristic.  
The user profile is loaded and activated.
- ① If you select **Continue Without Selecting a User**, no specific settings for the user profile are loaded.





### Configuring and deleting suggestions

- ▶ Select .
- ▶ Select **Settings**.
- ▶ Select **System**.
- ▶ Select **Suggestions**.
- ▶ Select .
- ▶ Switch the options on or off individually.  
If an option is switched on and sufficient data has been gathered, personalized suggestions based on your user behavior will be offered to you on the zero layer. These are, for example, navigation destinations visited, phone numbers

dialled as well as suggestions based on your music preferences.

- ▶ **To delete collected suggestions:** select .
- ▶ Select **Yes**.  
The suggestions are reset.

### Adding favorites from categories

- ▶ Select .
- ▶ Select .
- ▶ Select .
- ▶ Select  **Create New Favorite**.
- ▶ Select the category.
- ▶ Select a favorite.

## System settings

### Overview of the system settings menu

In the system settings menu, you can make settings in the following menus and control elements:

- Display
  - Display brightness
- Control elements
  - Keyboard language and handwriting recognition
  - Sensitivity of the Touch Controls
- MBUX Voice Assistant
- Sound
  - Entertainment
  - Navigation and traffic announcements
  - Telephone
- Data protection
- Connectivity
  - Wi-Fi, Bluetooth®, NFC
- Time & date
- Language
- Units for distance
- System PIN
- Suggestions
- Software update
- System reset

### Overview of software updates

Important software updates may be necessary for the security of your multimedia system's data.

Install these updates, or else the security of your multimedia system cannot be ensured.

The multimedia system displays a corresponding message when a software update is available.

If the **Automatic Online Update** option is active, software updates are downloaded automatically. If the option is deactivated, you will be informed of new software updates once. The software updates are available for downloading for a limited period of time.

Carrying out software updates:

- You can start software updates via the communication module.
  - You can start software updates via a WLAN hotspot.
  - You can start map updates from an external medium.
- ❗ Online software updates cannot be performed via external WLAN hotspots that are encrypted via TKIP.
  - ❗ If the WLAN hotspot requires logging in via the browser, once the connection is successfully established the browser will open in order to start the update. Follow the instructions in the browser in order to start the download.
  - ❗ To complete software updates via the communication module, the vehicle must be connected with the Internet and a Mercedes me user account.
  - ❗ To complete software updates via WLAN, the vehicle must be connected to an external WLAN hotspot.

A software update consists of three steps:

- Downloading or copying of the data required for installation
  - Installation of the downloaded software update
  - Activation of the downloaded software update
- ❗ It may be necessary to restart the MBUX multimedia system after completion of a software update.
  - ❗ While some software updates are being downloaded, the multimedia system cannot be operated and the vehicle functions may be restricted.
  - ❗ Some software updates require a safe vehicle status for the installation to be completed. They can only be carried out in a safely parked vehicle with the vehicle switched off.

**For software updates requiring a safe vehicle status:** when the last installation step is reached, a message appears on the media display after the vehicle is switched off. Follow the step-by-step instructions on the media display to complete the installation.

There are software updates that can only be installed when the vehicle is safely parked, there are no more people in the vehicle and the vehicle is locked.

#### Availability of the media display

During the installation of software updates, it is neither possible to use the vehicle nor the media display. You may receive a display message when an installation is in progress.

- ❗ The display message does not appear every time a software update is installed.

In rare cases, an error can occur during the installation. The multimedia system automatically attempts to restore the previous version.

If restoration of the previous version is not possible, a message appears on the media display.

#### Failure of the media display

If the media display fails or the display message shown above is shown continuously, several systems such as the rear view camera, Parking Assist PARKTRONIC or climate control are no longer available. Drive on carefully and consult a specialist workshop as soon as possible.

#### Setting up a Wi-Fi hotspot

##### Requirements:

- The Wi-Fi function is activated on the multimedia system and the communication device to be connected.
- The communication device to be connected supports at least one of the types of connection described.

The connection types shown depend on the device to be connected. The function must be supported by the multimedia system and by the device to be connected. The type of connection must be selected on the multimedia system and on the device to be connected.

- ❗ Some functions may first need to be activated on the communication device being connected. More detailed information can be found in the manufacturer's operating instructions.
- ❗ The use of the vehicle data tariff by external devices is not available in all countries.



Multimedia system:

→  >> Settings >> System

>> Internet and Bluetooth

**i** The availability of the functions is dependent on the country.

▶ Select **Wi-Fi**.  
The controller is to the right: Wi-Fi is switched on.

When the Wi-Fi function is switched on, you can connect the multimedia system with external hotspots or make it available as a hotspot for external devices.

When the Wi-Fi function is switched off, it is not possible to establish a hotspot connection.

**i** Depending on the vehicle equipment, you can purchase a data package directly from a mobile phone network provider via the Mercedes me Store. To be able to use the data package, you conclude a separate contract with a mobile phone network provider via the Mercedes me Store, which can be terminated at any time and for which there are no costs. This contract is a prerequisite for using the services from the previously purchased package. The availability of this option is dependent on the country. If the data package option is not available or can be upgraded, you can purchase data volume directly from the mobile phone network provider for a fee.

**i** The use of the vehicle data tariff by external devices is not available in all countries.

**Using the multimedia system as a Wi-Fi hotspot**

▶ Select **MBUX Hotspot**.  
▶ Select one of the following connection options.

**Connecting using a QR code**

Requirement: an app for scanning the QR code is installed on the device being connected.

Alternatively: the device being connected has an integrated QR code scanner (see the manufacturer's operating instructions).

▶ Scan the QR code shown.  
The Wi-Fi connection is established.

**Connecting using NFC**

▶ Activate NFC on the device to be connected.  
▶ When the NFC symbol is displayed in the **MBUX Hotspot** menu, hold the device to be connected to the NFC interface.

▶ Follow the instructions on the device.  
The Wi-Fi connection is established.

**Connecting using a security key**

▶ Select the vehicle from the device to be connected. The vehicle is displayed with the **MBUX XXXXX** network name.  
▶ Enter the security key which is shown in the media display on the device to be connected.  
▶ Confirm the entry.

**Generating a new security key**

▶ Select the **Generate New Security Key** option in the **MBUX Hotspot** menu.  
▶ Confirm the prompt with **Yes**.  
A new security key is generated.

A connection will be established with the newly created security key.

**i** When a new security key is generated, all existing Wi-Fi connections are then disconnected. If the Wi-Fi connections are being re-established, the new security key must be entered.

**Using a mobile communication device as a Wi-Fi hotspot (tethering)**

**i** This function is country-dependent.  
▶ Select the **Manage Internet Access** option in the **Internet and Bluetooth** menu.  
**i** The Wi-Fi function on the mobile phone and Internet access via Wi-Fi must be activated (see the manufacturer's operating instructions).

▶ Select **Search for Access**.  
▶ Select the network.  
▶ Log in to the Wi-Fi network.

or

▶ Select the mobile phone with the  Wi-Fi symbol.

**i** With external Wi-Fi hotspots, which are encrypted via TKIP, online software updates cannot be carried out via the external Wi-Fi hotspot.

**System language**

**Notes on the system language**

This function allows you to determine the language for the menus and the navigation announcements. The selected language affects the characters available for entry. The navigation announcements are



not available in all languages. If a language is not available, the navigation announcements will be in English.

### Setting the language

Multimedia system:

→  » Settings » System  
» Language

### Setting the system language

A list of the available system languages is shown.

- ▶ Select a language.  
The system language is switched to the selected language.

### Resetting the multimedia system (reset function)

**⚠ WARNING** Risk of accidents due to failure of multimedia display functions

While the multimedia system is being reset, its functions such as the rear view camera are not available.

- ▶ Only reset the multimedia system when the vehicle is stationary.

### Requirements:

- The vehicle is switched on.
- Some settings can only be reset when the vehicle is stationary.

Multimedia system:

→  » Settings » System » Reset

When resetting the system, personal data and settings are deleted, for example:

- Connected devices
  - Individual user profiles
  - Biometric data
- i** The data used and saved in the multimedia system by the driver assistance systems is deleted.
- ▶ Select **Reset**.  
A query appears asking if the system should really be reset.
  - ▶ Select **Yes**.  
The multimedia system is reset to its state at delivery. The multimedia system is restarted after the system reset.
- i** Due to data protection, as well as the function of individual driving systems and driving safety systems, it is a requirement to carry out a complete system reset before selling the vehi-

cle or transferring it to a third party, or after use as a hire car.

### Navigation

#### Switching on navigation

Multimedia system:



→  » Navigation

- ▶ Alternatively, switch on the MBUX Voice Assistant .
- ▶ Switch to navigation.  
The map appears.

### Navigation overview

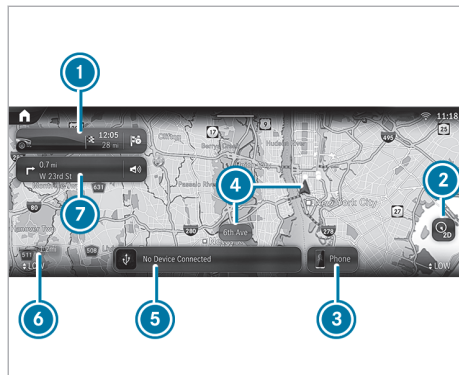
#### Digital map



- 1** Navigation module (reduced view)  
Route guidance active:  
The navigation module shows the information relevant to the route in the zoomed-out view, e.g. the destination or a traffic delay  
 Ends the current route guidance  
Tapping opens the navigation module and displays the route overview
- 2** Sets map orientation  and map type
- 3** Calls up the telephone menu
- 4** Current vehicle position (vehicle symbol or arrow)
- 5** Calls up entertainment applications
- 6** Elevation and map scale

- 7 Navigation window shows the next driving maneuver (zoomed out view) or the route monitor (zoomed in view)

Route guidance active: route monitor shows, e.g. route sections, upcoming driving maneuvers with lane recommendations, destination, traffic delays, 3D images at freeway exits, online content

Pressing 2 several times changes the map orientation in this order:

- 2D and to the north
- 2D and direction of travel
- 3D and direction of travel
- Map with complete route

- i If the map is moved, the map switches between 3D direction of travel and 2D north orientation.

The following map types 2 are available:

- Daytime display
- Night-time display
- Satellite map

- i If you notice a problem with the digital map you can report this under <https://mapfeedback.here.com/#/report>.

### Navigation module (expanded view)

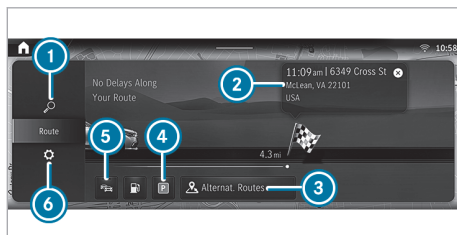

Example: route guidance is active

- 1 Enters an address or POI
- 2 Destination and time of arrival  
Beneath this, the current distance to the destination and the checked flag
- 3 Alternative routes
- 4 Searches for parking
- 5 Switches traffic information display on or off
- 6 Makes settings for [View, Messages & Acoustic Signals](#) and [Route](#)

### Entering a destination

#### Requirements:

- For the online search:
  - There is an Internet connection.
  - Mercedes me connect is available.
  - You have set up a user account in the Mercedes me Portal.
  - The vehicle is connected with the user account and you have accepted the terms of use.
  - Further information can be found at: <https://www.mercedes.me>
  - The service is available.
  - The service has been activated at an authorized Mercedes-Benz Center.

- i If Online Search is not available, the search is performed using the data of the digital map.

Multimedia system:

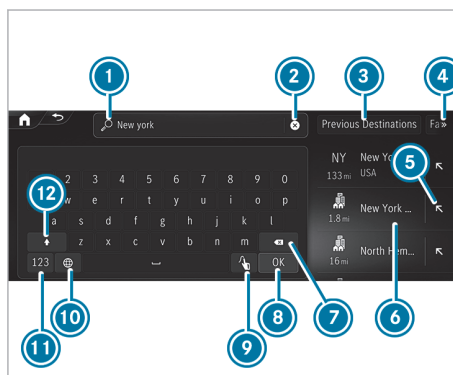

Example: entering a POI or address

- 1 Input line with current input
- 2 Deletes an entry
- 3 Selects previous destinations
- 4 Displays and selects additional destination searches
- 5 Adopts the search result in the input line and continues the search
- 6 Search result
- 7 Deletes the last character entered
- 8 Hides the keypad
- 9 Switches to handwriting recognition
- 10 Sets the written language

- 11 Switches to digits and special characters
- 12 Switches to upper-case or lower-case letters

If available, selecting the  symbol starts the MBUX Voice Assistant.

▶ Enter the destination in ①. The entries can be made in any order.  
The search results are displayed in a list.

- ① Online search results for POIs may contain additional information, for example opening times and ratings. The information is provided by an online map service.  
This online function is not available in all countries.
- ② You can enter a destination as a three-word address from what3words.  
This option is not available in all countries.

▶ Hide the keyboard with .

▶ Select the destination in the list.  
The following menu shows the selected destination with the address information and a corresponding map section.

The menu enables the route to be calculated.

- ③ Observe the notes on the MBUX multimedia system (→ page 149).

### Calculating a route and using settings for route guidance

#### Requirements:

- The destination has been entered.
- The destination address is shown.
- **For Navigation with Electric Intelligence:**
  - Mercedes me connect is available.
  - You have a Mercedes me connect user account and the vehicle is connected with the account.
  - The "Navigation with Electric Intelligence" service is available and activated in the Mercedes me Portal.  
The services "Navigation with Electric Intelligence", "Display of charging stations" and "Mercedes me Charge" are required for optimal function.
  - The **Plan Charging Stops** route option is switched on.



Example: detailed display

- ① Calls up alternative routes
- ② Calculates the route and starts route guidance
- ③ Selects a point of interest in the vicinity of the destination
- ④ Destination address

The route with Electric Intelligence is automatically and intelligently calculated to the destination. The route is updated during route guidance. The route with Electric Intelligence contains the required charging stops as intermediate destinations. The charging stations are determined taking into account the distance to be traveled and the estimated charging times.

▶ Select one of the options.

- ① When the **Plan Charging Stops** route option is switched off, a route without charging stations is calculated.



#### Calling up alternative routes

- ▶ Select **Routes**.
- ▶ Select an alternative route.

#### Starting route guidance

- ▶ Select  **Let's Go!**

#### Calling up the detailed display with destination address

- ▶ Pull the bar above ② upwards.  
Depending on the destination selection and availability, online content, for example ratings and weather information, is shown.  
If the destination is in a different time zone, a message is displayed.
- ▶ **To share a destination:** select  **Share**.  
This option allows you to scan the displayed QR code.
- ▶ **To save a destination as a favorite:** select  **Favorite** and then an option.
- ▶ **To call up an Internet address:** if a web address is available, select **www**.

- ▶ **To call the destination:** if a telephone number is available, select **Call**.

#### Searching for POIs in the vicinity of the destination shown

- ▶ Select **In The Vicinity**.
- ▶ Search using categories, enter a search entry or search for a personal POI.

#### Adding an intermediate destination to the existing route or starting a new route guidance



- ▶ Select  **Add**.  
The selected destination address is set as the next intermediate destination. Route guidance begins.

- ▶ **There are already four intermediate destinations:** confirm the prompt with **Yes** and select an intermediate destinations in the route overview, that should be overwritten with the new intermediate destination.

or

- ▶ Select  **Replace**.  
The selected destination address is set as a new destination. Route guidance begins.

#### Selecting a route type

- ▶ In the navigation module (expanded view), select .
- ▶ Select **Route**.  
The route is calculated as a fast route with a short journey time. Trailer mode is available if a trailer has been coupled with the vehicle. If available, you can select online routes. Traffic announcements for the route are taken into account via **Reroute Based on Traffic** .

- ▶ **i** Trailer mode and online routes are not available in all countries and for all vehicles.

#### Calculating alternative routes

- ▶ In the navigation module (expanded view), select .
- ▶ Select **View**.
- ▶ Activate **Route Overview after Start**.  
Alternative routes are calculated for every route.

#### Selecting alternative routes

- ▶ **i** If **Route Overview after Start** has been switched on and a route has been calculated, the function is available.
- ▶ In the navigation module (expanded view), select **Alternative Routes**.

- ▶ When the alternative routes have been calculated, display the route in the navigation window by swiping to the right or left.
- ▶ Select **Start**.

#### Activating a commuter route

- ▶ **i** A user profile has been created and **Allow Destination Suggestions** has been activated in the user options. Route guidance is not active.

- ▶ In the navigation module (expanded view), select .
- ▶ Select **Route**.
- ▶ Activate **Commuter Route**.  
The navigation system automatically detects that the vehicle is on a commuter route.  
For the daily commuter route, traffic incidents on the route are also reported when driving without active route guidance.

- ▶ **To select or delete a commuter route:** select **Start** or .

#### Avoiding or using route sections, e.g. highways or ferries

- ▶ In the navigation module (expanded view), select .
- ▶ Select **Route**.
- ▶ Select **Avoid Options**.
- ▶ Activate or deactivate the avoid option.

#### Using map functions

Multimedia system:



#### Increasing map scale

- ▶ When the map is shown, tap twice quickly with one finger on the media display.

or

- ▶ Move two fingers apart on the media display.

#### Decreasing map scale

- ▶ Tap with two fingers on the media display.

or

- ▶ Move two fingers together on the media display.

#### Moving the map

- ▶ When the map is displayed, swipe in any direction with one finger on the media display.
- ▶ **To reset the map to the current vehicle position:** select  **Center**.

### Selecting map orientation

- ▶ Tap repeatedly on the  compass symbol on the map.
- The map orientations changes in this order:
- The 2D map view is displayed so that north is always at the top.
  - The 2D map view is aligned to the direction of travel.
  - The 3D map view is aligned to the direction of travel.
  - The map shows the complete route.

### Using services

#### Requirements:

- There is an Internet connection.
- Mercedes me connect is available.
- You have set up a user account in the Mercedes me Portal.
- The vehicle is connected to a user account and you have accepted the conditions of use for the service.
 

Further information can be found at: <https://www.mercedes.me>
- The service is available.
- The service has been activated at an authorized Mercedes-Benz Center.

Multimedia system:



#### Showing traffic information

- ▶ In the navigation module (expanded view), select  (→ page 157).
- ▶ Select **View**.
- ▶ Activate **Traffic**.
- ▶ Activate **Traffic Incidents** and **Free Flowing Traffic**.
 

Traffic incidents, for example roadworks, local area reports (e.g. fog) and warning messages, are shown on the route.

The traffic delay is displayed for the current route. The smallest value for the display for traffic delays is a minute.

#### Displaying hazard warnings

If hazard warnings are available these can be shown as symbols on the map. The display depends on the settings for the **Traffic Incidents** option.

- ▶ In the navigation module (expanded view), select  (→ page 157).
- ▶ Activate or deactivate **Traffic Incidents**.
 

If the option is activated, all of the symbols are shown.

If the option is deactivated, the symbols are only shown when there is a hazard warning.

The following hazards may be shown on the map:

  - Accidents and breakdowns
  - Slippery roads, fog, crosswinds and heavy rain
  - Hazards reported manually
  - Vehicle with active hazard warning light
  - Roadworks
  - Additional hazards (if available)

#### Displaying online map contents

- ▶ In the navigation module (expanded view), select .
- ▶ Select **View**.
- ▶ Switch on an online service, e.g. **Weather**.
 

Current weather information is displayed on the navigation map, e.g. temperature or cloud cover.

The service information is not shown in all map scales, e.g. weather symbols.

#### Parking service

**!** **NOTE** Vehicle damage due to failure to observe the maximum permissible clearance height

If the vehicle height exceeds the maximum permissible clearance height, the roof and other vehicle parts may be damaged.

- ▶ Please observe the maximum clearance height indicated.
- ▶ If the vehicle exceeds the permissible clearance height, do not drive in.
- ▶ Take the modified vehicle height into account in the case of roof superstructures or other carrier systems.

**!** **NOTE** Vehicle damage due to failure to observe local information and parking conditions

The data is based on the information provided by the respective service providers.

Mercedes-Benz does not guarantee the accuracy of the information provided in relation to the car park or parking area.

- ▶ Always observe the local information and conditions.

**i** This service is not available in all countries.

▶ In the navigation module (expanded view), select  and switch on **Parking**.

▶ Tap on **P** the map.

or

▶ In the route overview, select **P** **Parking Spaces**.

▶ Select the search position and search filter, e.g. **Near Destination** and **Parking Garage**. The map shows car parks suited to the selected settings.

▶ Select a parking option. The map shows the parking options in the vicinity.

The following information is displayed (if available):

- Destination address, distance from current vehicle position and arrival time
- Information on the parking garage/car park facility

For example, opening times, parking charges, current occupancy, maximum parking time, **maximum access height**.

The maximum access height shown by the parking service does not replace the need for observation of the actual circumstances.

- Available payment options (Mercedes pay, coins, bank notes, cards)
- Details on parking tariffs
- Number of available parking spaces
- Payment method (e.g. at parking meters)
- Services/facilities at the parking option
- Telephone number

▶ Calculate the route (→ page 159).

### Overview of Smartphone Integration

With Smartphone Integration, you can use certain functions on your mobile phone via the multimedia system display.

Only one mobile phone at a time can be connected via Smartphone Integration to the multimedia sys-

tem. Also for use with two phone mode with smartphone integration, only one additional mobile phone can be connected using Bluetooth® with the multimedia system.

The full range of functions for Smartphone Integration is only possible with an Internet connection. The appropriate application must be downloaded on the mobile phone to use Smartphone Integration. The mobile phone must be switched on and connected to the multimedia system via the USB port using a suitable cable.

Apps for Smartphone Integration:

- Apple CarPlay® (wireless connection via Bluetooth® also possible)
- Android Auto (wireless connection via Bluetooth® also possible)

**i** For safety reasons, the first activation of Apple CarPlay® or Android Auto on the multimedia system must be carried out when the vehicle is stationary with the parking brake.

You can start Smartphone Integration using the **Devices** menu.

You can end Smartphone Integration via the **Devices** or by disconnecting the connecting cable between the mobile phone and multimedia system.

**i** Mercedes-Benz recommends disconnecting the connection via the device manager or the connecting cable only when the vehicle is stationary.

### Overview of transferred vehicle data

When using Smartphone Integration, certain vehicle data is transferred to the mobile phone. This enables you to get the best out of selected mobile phone services. Vehicle data is not directly accessible.

The following system information is transmitted:

- Software release of the multimedia system
- System ID (anonymized)

The transfer of this data is used to optimize communication between the vehicle and the mobile phone.

To do this, and to assign several vehicles to the mobile phone, a vehicle identifier is randomly generated.

This has no connection to the vehicle identification number (VIN) and is deleted when the multimedia system is reset (→ page 157).

The following vehicle status data is transmitted:

- Transmission position engaged
- Distinction between parked, standstill, rolling and driving
- Day/night mode of the instrument cluster
- Drive type

The transfer of this data is used to alter how content is displayed to correspond to the driving situation.

The following position data is transmitted:

- Coordinates
- Speed
- Compass direction
- Acceleration direction

The mobile phone uses this data to improve the accuracy of navigation, for example, when driving through a tunnel.

### Web browser overview



- ① Previous website
  - ② Next website
  - ③ Update
  - ④ URL
  - ⑤ Adds/removes bookmarks
  - ⑥ Options
  - ⑦ Settings
- ① Under **⋮** you have the following options:
- [Bookmarks & History](#)
  - [Reading Mode](#)
  - [Request Mobile Website](#)
- ① Websites cannot be shown while the vehicle is in motion.

### Sound settings

#### Overview of functions in the Sound menu

The setting options and functions available depend on the sound system installed. You can find out which sound system is installed in your vehicle in the Digital Operator's Manual.

#### Standard sound system

The following functions are available:

- Equalizer
  - Treble, mid-range and bass
- Balance and fader
- Volume
  - Automatic adjustment

### Notes on loading guidelines

#### **▲ WARNING** Risk of injury from unsecured objects in the vehicle

When objects are unsecured or inadequately secured, they can slip, tip over or be thrown about, striking vehicle occupants.

This also applies to:

- Luggage or loads
- Seats which have been removed and are being transported in the vehicle in an exceptional case

There is a risk of injury, particularly in the event of braking maneuvers or abrupt changes in direction.

- ▶ Always stow objects in such a way that they cannot be tossed about.
- ▶ Before traveling, secure objects, luggage or load to prevent them slipping or tipping over.
- ▶ When a seat is removed, keep it preferably outside the vehicle.

#### **▲ WARNING** Risk of injury due to objects being stowed incorrectly

If objects in the vehicle interior are stowed incorrectly, they can slide or be thrown around and hit vehicle occupants. In addition, cup holders, open storage spaces and mobile phone receptacles cannot always retain all objects within.

There is a risk of injury, particularly in the event of sudden braking or abrupt changes in direction.

- ▶ Always store objects such that they cannot be thrown around in such situations.
- ▶ Always make sure that objects do not protrude from storage spaces, parcel nets or storage nets.
- ▶ Close the lockable storage spaces before starting a journey.
- ▶ Stow and secure objects that are heavy, hard, pointed, sharp-edged, fragile or too large in the cargo compartment.

If you are using a roof luggage rack, please note the maximum roof load and the maximum load capacity of the roof luggage rack. (→ page 225)

Camera-based driving systems and the sensor functions of the inside rear-view mirror may be impaired if you are transporting a load on the roof and it protrudes more than 16 in (40 cm) over the front edge of the roof. Therefore, make sure that the load does not protrude by more than 16 in (40 cm).

The handling characteristics of your vehicle are dependent on the load distribution.

Therefore, please observe the following notes when loading:

- When transporting a load, never exceed the gross vehicle weight rating or the gross axle weight rating for the vehicle (including occupants). The figures are specified on the vehicle identification plate on the B-pillar.
- The load must not protrude above the upper edge of the seat backrests.
- If possible, always transport the load in the cargo compartment.
- Fasten the load to the cargo tie down rings and distribute the load evenly among them.
- Use cargo tie down rings and fastening materials that are suitable for the weight and size of the load.

### Notes on distributing the load within the vehicle

#### **!** **NOTE** Damage to the floor covering due to uneven loading

Excessive point loading on the cargo compartment floor or on the load area can negatively affect the driving characteristics and could damage the floor covering.

- ▶ Distribute the load evenly. When doing so, ensure that the overall center of gravity of the load is always as low and close to the center as possible and between the axles near the rear axle.

Observe the following notes:

- always transport loads in the cargo compartment.
- always additionally secure the load with suitable load securing aids or lashing material.



## Securing loads

### Notes on load securing

**⚠ WARNING** Risk of accident and injury due to incorrect use of the lashing straps

The following can occur:

- The tie-down eyes may detach or the lashing strap may tear if the permissible load is exceeded
- The load cannot be restrained

The load can slip, tip over or be flung about, striking vehicle occupants.

- ▶ Always tension the lashing straps in the proper manner and only between the described tie-down eyes.
- ▶ Always use lashing straps designed specifically for the loads.

- i** Observe the information relating to the maximum loading capacity of the individual cargo tie-down points. If you combine various cargo tie-down points to secure a load, always take the maximum loading capacity of the weakest cargo tie-down point into account. During maximum full-stop braking, forces may act which can multiply the weight of the load. Always use several cargo tie-down points to distribute the load. Spread the load evenly between the cargo tie-down points or tie-down eyes.

Observe the Operating Instructions or the lashing strap manufacturer's instructions for the operation of the lashing strap.

Observe the information relating to the maximum loading capacity of the cargo tie-down points (→ page 225).

As the driver, you are responsible for ensuring the following:

- The load is secured against slipping, tipping, rolling or falling off.  
Take usual traffic conditions as well as swerving or full brake application and bad roads into account.
- The applicable requirements and guidelines relating to load-securing practices are met.  
If this is not the case, this may constitute a punishable offense, depending on local legislation and any ensuing consequences. Observe country-specific laws.

Make sure that the load is secure before every journey and at regular intervals during a long journey. Adjust the load securing as necessary. Information on how to secure loads correctly can be obtained from the manufacturers of the load securing aids or tie downs for load securing, for example.

When securing loads, observe the following:

- Fill spaces between the load and the cargo compartment walls or wheel wells. For this purpose, use rigid load securing aids, such as chocks, wooden fixings or padding.
- Attach secured and stabilized loads in all directions.

Use the cargo tie-down points or tie-down eyes and the loading rails in the cargo compartment.

Only use tie downs, such as lashing rods, lock rods or lashing nets and lashing straps, which have been tested in accordance with current standards (e.g. DIN EN). Always use the cargo tie-down points closest to the load and pad sharp edges.

Loads, and heavy loads in particular, should preferably be secured using the tie-down eyes.

- i** You can obtain tie downs tested in accordance with current standards (e.g. DIN EN) from any specialist company or from a qualified specialist workshop.

### Notes on the partition

Without a partition, vehicles that are approved as commercial vehicles (vehicle category N1, N2) do not fulfill standard ISO 27956, which describes the equipment for properly securing a load in delivery vehicles. If the vehicle is used to transport goods, retrofitting the partition is strongly recommended, as properly securing the load in vehicles without a partition will always be a complex operation.

- i** Nothing may be stowed in the area between the rear side of the seats and the partition.

### Overview of cargo tie-down point

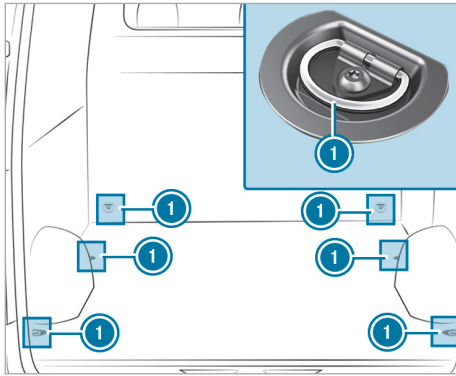

Cargo tie-down points (example: cargo van without loading rails)

#### ① Cargo tie-down rings

Secure loose loads with an approved lashing net or a tarp.

Always fasten the lashing net or tarp to all available cargo tie-down points. Make sure that the fastening hooks are secured against accidental opening.

If your vehicle is equipped with loading rails in the cargo floor, you can place lashing rods directly in front of and behind the load. The lashing rods directly absorb the potential shifting forces.

Securing loads on the cargo floor by lashing them down is recommended only for lightweight loads. Lay anti-slip mats under the load to assist in securing it.

### Installing and removing cargo tie-down rings

▶ **To install:** slide the cargo tie-down ring through a recess in the loading rail close to the load until the locking mechanism engages in the recess.

① When you pull the locking mechanism up and out of the recess, the cargo tie-down ring is able to move within the loading rail. Make sure that the locking mechanism is always engaged in a recess.

▶ Check the cargo tie-down ring for firm seating.

▶ **To remove:** pull the locking mechanism up and pull the cargo tie-down ring towards the locking mechanism and out of the loading rail through a recess.

### Carrier systems

#### Information on the roof luggage rack

⚠ **WARNING** Risk of injury if maximum roof load is exceeded

The vehicle center of gravity and the usual driving characteristics as well as the steering and braking characteristics will change.

If you exceed the maximum roof load, the handling as well as steering and braking characteristics are severely affected.

▶ Always comply with the maximum roof load and adjust your driving style.

⚠ **NOTE** Vehicle damage due to failure to observe the maximum permissible clearance height

If the vehicle height exceeds the maximum permissible clearance height, the roof and other vehicle parts may be damaged.

▶ Please observe the maximum clearance height indicated.

▶ If the vehicle exceeds the permissible clearance height, do not drive in.

▶ Take the modified vehicle height into account in the case of roof superstructures or other carrier systems.

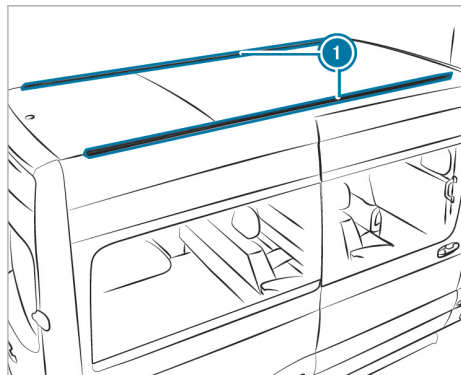

#### ① Mounting rails

Information about the maximum roof load can be found in the "Technical data" section (→ page 225).

Observe the following points for installing roof luggage racks:

- Tighten the screws of the roof luggage rack with a torque of 6.0 lb-ft (8 Nm) – 7.4 lb-ft (10 Nm) in the designated sliding blocks.
- The tightened screws should not touch the rails.
- Ensure that the sliding blocks are not located in the areas around the plastic caps.
- The sliding blocks must have the right cross-section.
- The insides of the mounting rails must be free of dirt.
- Re-tighten the screws uniformly after around 300 miles (500 km).

Mercedes-Benz recommends that you use only roof luggage racks that have been tested and approved for Mercedes-Benz. These help to prevent vehicle damage.

Have mounting rails retrofitted only at a qualified specialist workshop. Otherwise, you could damage the vehicle.

If your vehicle is equipped with mounting rails on the roof, you can install a roof luggage rack on the roof. Special fasteners (sliding blocks) are available as accessories for this purpose.

These fasteners are available from any authorized Mercedes-Benz Center.

**i** A wheel arch may be subjected to a load of 330 lb (150 kg).

### Placing a load on the wheel arch

Comply with the important safety notes under "Notes on loading" (→ page 164).

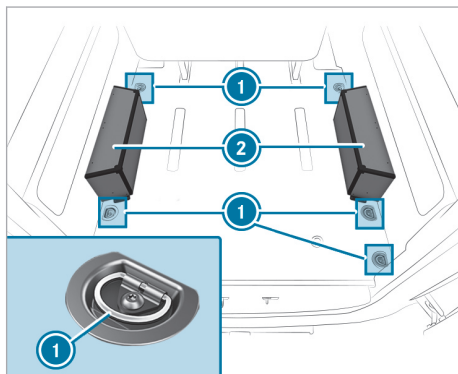

- ▶ Place the objects on wheel arch **2** and lash them using tie-down eyes **1** (→ page 166).

## ASSYST PLUS service interval display

### Function of the ASSYST PLUS service interval display

The ASSYST PLUS service interval display on the instrument cluster provides information on the remaining time or distance before the next service due date.

You can hide this service message by using the back button on the left-hand side of the steering wheel.

You can obtain further information concerning the servicing of your vehicle from a qualified specialist workshop, e.g. an authorized Mercedes-Benz Center.

### Displaying the service due date

On-board computer:

➔ Service ➔ ASSYST PLUS

The next service due date is displayed.

▶ **To exit the display:** press the back button on the left-hand side of the steering wheel.

Bear in mind the following related topic:

- Operating the on-board computer

### Have service work carried out regularly

**!** **NOTE** Premature wear through failure to observe service due dates

Maintenance work which is not carried out at the right time or incompletely can lead to increased wear and damage to the vehicle.

- ▶ Adhere to the prescribed service intervals.
- ▶ Always have the prescribed maintenance work carried out at a qualified specialist workshop.

### Special service requirements

The prescribed service interval is based on normal vehicle use. Perform maintenance work more often than prescribed if the vehicle is operated under arduous operating conditions or increased loads.

Examples of arduous operating conditions:

- Frequent operation in mountainous terrain or on poor road surfaces
- Operation in particularly dusty conditions and/or if air-recirculation mode is frequently used

In these or similar operating conditions, have the interior air filter, for example, changed more frequently. Check the tires more frequently if the vehicle is operated under increased stress. You can obtain further information at a qualified specialist workshop.

### Non-operational times with the battery disconnected

**The ASSYST PLUS service interval display can calculate the service due date only when the battery is connected.**

▶ Display and note down the service due date on the instrument cluster before disconnecting the battery (→ page 168).

## Calibrating the high-voltage battery

### Notes on calibrating the high-voltage battery

Your vehicle's high-voltage battery is equipped with LFP technology (lithium iron phosphate). In comparison to NMC (nickel manganese cobalt), this technology is characterized by a particularly long service life and environmental safety.

In order to provide the most accurate range display, charging time prediction and charge level display, LFP technology requires regular calibrations of the high-voltage battery.

Two types of calibration are required for an accurate calibration of the high-voltage battery:

- A regular normal calibration of the state of charge of the high-voltage battery. This takes place during the process of fully charging the high-voltage battery (→ page 108, 169).
- A special calibration of the high-voltage battery. This is used to determine the age-related battery capacity, ideally twice a year. Among other things, the special calibration requires the high-voltage battery to be charged from a low state of charge (→ page 169).

A special calibration can also be performed manually (→ page 170).

### Further information

- i** The amount of time the vehicle remains connected to a public charging station is increased if the high-voltage battery is calibrated during or after the charging process. Attention is drawn to extended charging times via display messages. If a public charging station is locked, additional fees may be incurred, depending on the operator's terms of use.
- i** If the power supply is switched on or electrical consumers are used during calibration, the calibration may be aborted.
- i** Setting a departure time may result in there being insufficient time for the planned calibration. If you require the state of charge to be as high as possible by the departure time, set a departure time .
- i** Low outside temperatures can have a negative impact on the calibration. It is advisable to perform the calibration at temperatures above 59 °F (15 °C).
- i** The need for calibration:

  - is dependent on use
  - is indicated by display messages in the instrument cluster (→ page 235).
  - can be verified via the on-board computer (→ page 142).
  - can be covered by performing a manual calibration (→ page 170)

### Why is regular calibration necessary?

- i** If the battery continues to be insufficiently calibrated, large deviations in the predicted range may result. There is a risk the vehicle's drive may experience a loss of output which either comes unexpectedly or for which a warning is issued too late. As a result, it may no longer be possible to continue the journey.

Batteries age over time and slowly lose some of their capacity, in other words, their ability to provide energy. This means that the 100% state of charge displayed in a vehicle that is one year old, for example, has a lower energy content than the 100% state of charge displayed in a new vehicle. During the calibration process, the exact energy content of the 100% state of charge is determined. The lower states of charge, the range and the charging time are calculated based on this determination.

Without calibration, the information displayed with respect to the range, the predicted range and the state of charge will become increasingly imprecise.

### Calibrating the high-voltage battery

#### Requirements

- There is enough time and space to completely charge the high-voltage battery even if the charging time is extended.
- You are familiar with the notes on calibrating the high-voltage battery (→ page 168).

#### Calibrating the high-voltage battery

The high-voltage battery can be calibrated in different ways:

- You confirm the display messages regarding calibration and follow the recommendations shown.
  - You call up the **Battery Calibration** menu and start the normal or special calibration from there (→ page 142).
  - You perform the special calibration of the high-voltage battery manually (→ page 170).
- Manual calibration is also possible when charging with direct current (DC).

The requirements for calibration are indicated by the following display messages:

- To Ensure Max. Range, Perform Battery Calibration Start Charge Process to 100%**

A normal calibration is required.
- To Ensure Max. Range, Perform Battery Calibration Extra Charging Time: XX min Start AC Charging to 100%**

A special calibration is required.
- Battery Calibration Required AC Charging to 100% Start Possible at State of Charge: Max. XX% Outside Temp.: Min. XX °F**

A special calibration is required.

- ▶ Perform a normal or special calibration as described below.

#### Performing a normal calibration

- i** Calibration will be carried out automatically during the next suitable charging process, once you have confirmed the calibration in the instrument cluster.

A calibration is suitable if the following conditions are met:

- You charge the vehicle up to a state of charge of 100%.

- ▶ Allow the vehicle to be charged until a state of charge of 100% has been reached.

### Performing a special calibration

- ① Calibration will be carried out automatically during the next suitable charging process, once you have confirmed the calibration in the instrument cluster.

A calibration is suitable if the following conditions are met:

- The state of charge is at a maximum of XX % at the beginning of the charging process, see display message in the instrument cluster.
- You charge the vehicle using alternating current (AC) until a state of charge of 100% has been reached.
- The outside temperature is at least 59°F (15°C).
- No departure time is set before the end of the charging time.

- ① During calibration, charging breaks may occur. Do not disconnect the charging cable from the vehicle. Otherwise the calibration may be interrupted.

- ① During the calibration, the charging time may be extended once only.

- ① Calibration can be interrupted if electrical consumers are connected or pre-entry climate control is activated.

- ▶ Confirm all display messages regarding calibration, provided the outside temperature and the state of charge conform to the required values shown in the display message. Calibration starts.

- ▶ Allow calibration to continue until the display message **Battery Calibration Successful Max. Battery Output and Range Restored** or **Battery Calibration Was Not Possible See Operator's Manual** appears.

### Battery Calibration Was Not Possible See Operator's Manual

- ▶ Check if a departure time has been preset that starts before the end of the charging time (incl. charging time extension) and deactivate it if possible (→ page 108).

- ▶ Check that the maximum state of charge is set to 100% (→ page 108).

- ▶ Check if an electrical consumer was used during calibration or the power supply was switched on.

- ▶ If possible, prevent the vehicle from cooling down too much or postpone calibration until the weather conditions are more favorable.

- ▶ Restart the calibration via the menu **Battery Calibration** in the instrument cluster (→ page 143).

- ▶ If the problems persist, perform a manual calibration of the high-voltage battery (→ page 170). Manual calibration is also possible when charging with direct current (DC).

### Manually calibrating the high-voltage battery

#### Requirements

- The outside temperature is at least 59°F (15°C).
- The state of charge is less than 15%.
- You are familiar with the notes on calibrating the high-voltage battery (→ page 168).

#### Manually calibrating the high-voltage battery

The high-voltage battery can be manually calibrated if the automatic calibration fails repeatedly or it is not possible to charge the battery using alternating current (AC).

- ▶ Park the vehicle in the immediate vicinity of a charging station that has a minimum output of 11 kW.

- ▶ The vehicle must remain parked for at least six hours.

- ① The remaining range of the high-voltage battery must be sufficient to reach the nearest charging station.

- ① Do not start or move the vehicle during the six hours in which it is non-operational. The doors must remain closed and neither the pre-entry climate control nor any electrical consumers can be active.

- ▶ Connect the vehicle to the charging station.

- ① While the vehicle is charging, electrical consumers can be active and the power supply can be switched on.

- ▶ Charge the vehicle up to a state of charge of 100%.  
When a state of charge of 100% has been reached, the calibration is finished.

## Engine compartment

### Opening and closing the hood

- ⚠ **DANGER** Risk of fatal injuries when carrying out maintenance work during the charging process

During the charging process, the high-voltage on-board electrical system is under high voltage.

- ▶ Do not perform any maintenance work during the charging process.

- ⚠ **WARNING** Risk of accident due to driving with the hood unlocked

The hood may open and block your view.

- ▶ Never release the hood when driving.
- ▶ Before every trip, ensure that the hood is locked.

- ⚠ **WARNING** Risk of injury due to overheated vehicle

If you open the hood in the event of an overheated vehicle or fire in the engine compartment, the following situations may occur:

- You may come into contact with hot gases.
- You may come into contact with other escaping hot operating fluids.
- ▶ In the event of overheating or fire in the engine compartment, keep the hood closed and call the fire service.
- ▶ Allow the overheated vehicle to cool down first if you need to open the hood.

- ⚠ **WARNING** Risk of injury due to moving parts

Components in the engine compartment can continue to run or start unexpectedly even when the vehicle is switched off.

Observe the following before performing tasks in the engine compartment:

- ▶ Switch off the vehicle.

- ▶ Never touch the danger zone surrounding moving components, e.g. the rotation area of the fan.
- ▶ Remove jewelry and watches.
- ▶ Keep items of clothing and hair away from moving parts.

- ⚠ **WARNING** Risk of burns from hot components in the engine compartment

Certain components in the engine compartment can be very hot, e.g. the drive system and the cooler.

- ▶ Allow the drive system to cool down and touch only the components described below.

If you have to carry out any work in the engine compartment, touch only the following components:

- Hood
- Washer fluid reservoir cap
- Coolant expansion reservoir cap

- ⚠ **WARNING** Risk of injury from using the windshield wipers when the hood is open

If the windshield wipers start moving when the hood is open, you could be trapped by the wiper linkage.

- ▶ Always switch off the windshield wipers and vehicle before opening the hood.

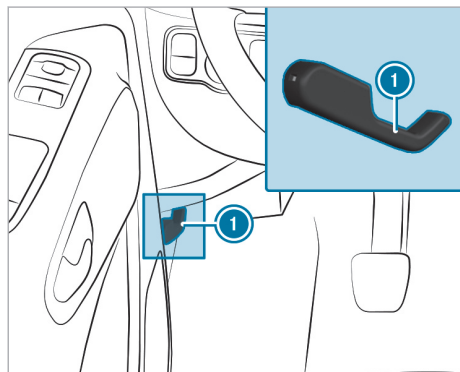

- ▶ Park the vehicle safely and on a surface that is as level as possible.
- ▶ Switch off the drive system.
- ▶ Secure the vehicle against rolling away.

**⚠ WARNING** Risk of injury when the hood is opened

The hood may suddenly drop into the end position.

There is a risk of injury for anyone in the hood's range of movement.

- ▶ Before releasing the hood, ensure that the support is firmly seated in the holder.
- ▶ Open the hood only when there is no-one in its range of movement.

### Opening the hood

- ▶ Pull handle ① to release the hood.
- ▶ Reach into the gap and push the hood catch handle upwards.
- ▶ Open the hood and hold it up.

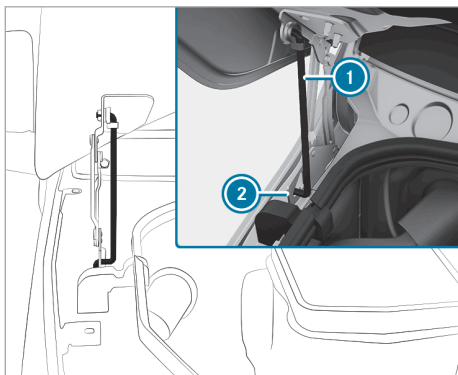

- ▶ Take support ① from the holder on the hood and pull it downwards.
- ▶ Insert the support into bracket ② below.

### Closing the hood

**⚠ WARNING** Risk of accident and injury when opening and closing the hood

The hood may suddenly drop into the end position.

There is a risk of injury for anyone in the hood's range of movement.

- ▶ Do not open or close the hood if there is a person in the hood's range of movement.

**! NOTE** Damage to the hood

Pushing the hood closed with your hands could damage it.

- ▶ To close the hood, let it drop from the specified height.

- ▶ Lift the hood slightly.
- ▶ Move support ① to the holder on the hood and apply light pressure to engage it.
- ▶ Lower the hood and let it drop from a height of approximately 0.5 ft (15 cm).
- ▶ If it is still possible to lift the hood a little, open the hood again and let it drop from a height of approximately 0.7 ft (20 cm) until it engages correctly.

### Checking the coolant level

If you have to carry out any work in the engine compartment, touch only the following components:

- Hood
- Washer fluid reservoir cap
- Coolant expansion reservoir cap

**⚠ WARNING** Risk of scalding from hot coolant

You may scald yourself if you open the cap when the drive system is at normal operating temperature.

- ▶ Allow the drive system to cool down before opening the cap.
- ▶ When opening the cap, wear protective gloves and safety glasses.
- ▶ Open the cap slowly to release pressure.

Allow the drive system and the cooling system to cool down before checking the coolant level or adding coolant.

The coolant temperature must be below 122°F (50°C).

**! NOTE** Paintwork damage due to coolant

If coolant gets on painted surfaces, the paintwork can be damaged.

- ▶ Add coolant carefully.
- ▶ Remove spilled coolant.



### Checking the coolant level

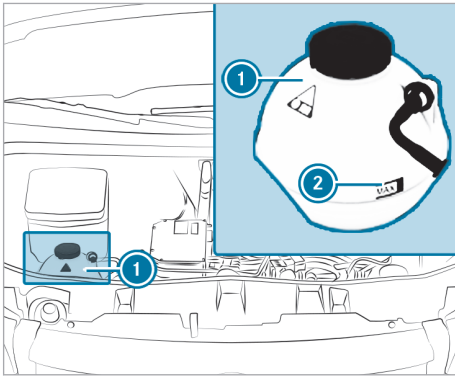

#### Coolant expansion reservoir (example)

- ▶ Park the vehicle on a level surface.
- ▶ Open the hood (→ page 171).
- ▶ Slowly turn coolant expansion reservoir cap ① half a turn counter-clockwise to release overpressure.
- ▶ Turn coolant expansion reservoir cap ① further and remove it.
- ▶ Check the coolant level. There is enough coolant in the coolant expansion reservoir if the coolant reaches upper MAX mark ②.

#### Adding coolant

- ▶ Refill the coolant to upper MAX mark ② on the coolant expansion reservoir.

Use only coolant approved by Mercedes-Benz to avoid damaging the engine cooling system.

- ▶ Replace coolant expansion reservoir cap ① and tighten it in a clockwise direction.
- ▶ Start the vehicle.
- ▶ After about five minutes, switch off the vehicle again and allow it to cool down.
- ▶ Check the coolant level again and add coolant if necessary.

- ① Observe additional coolant information (→ page 220).

### Filling the windshield washer system

- ⚠ **WARNING** Risk of fire and injury from windshield washer concentrate

Windshield washer concentrate is highly flammable.

- ▶ Avoid fire, open flames, smoking and the creation of sparks when using windshield washer concentrate.

- ⚠ **NOTE** Damage to the exterior lighting due to unsuitable windshield washer fluid

Unsuitable windshield washer fluid may damage the plastic surface of the exterior lighting.

- ▶ Only use windshield washer fluids that are also suitable for use on plastic surfaces, e.g. MB SummerFit or MB WinterFit.

#### Adding washer fluid

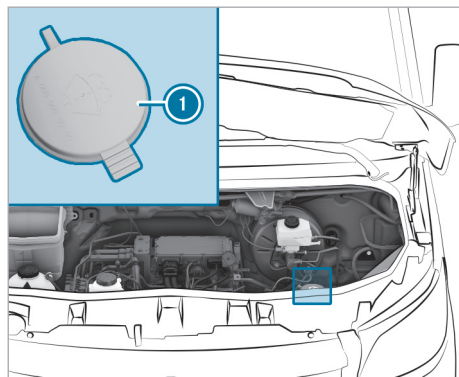

#### Washer fluid reservoir (example)

- ▶ Pre-mix the washer fluid in the correct mixing ratio in a container.
- ▶ Open the hood (→ page 171).
- ▶ Pull cap ① of the washer fluid reservoir upwards by the tab.
- ▶ Pour in the pre-mixed washer fluid.
- ▶ Push cap ① onto the filler opening until it audibly engages.
- ▶ Close the hood (→ page 171).
- ① Observe the further information about windshield washer fluid (→ page 221)

## Cleaning and care

### Notes on washing the vehicle in an automatic car wash

**⚠ WARNING** Risk of accident due to reduced braking effect after washing the vehicle

The braking effect is reduced after washing the vehicle.

- ▶ After the vehicle has been washed, brake carefully while paying attention to the traffic conditions until the braking effect has been fully restored.

**! NOTE** Risk of damage to the paintwork and plastic components

If you wash your vehicle in Touchless Automatic Car Wash systems that use special cleaning agents, the cleaning agents used can damage the paintwork or plastic components of the vehicle.

- ▶ Do not wash the vehicle in Touchless Automatic Car Wash systems that use special cleaning agents.

Make sure that the automatic car wash is suitable for the size of the vehicle.

Before washing the vehicle in an automatic car wash, fold in the outside mirrors and remove any additional antennas. Otherwise, the outside mirrors, antennas or the vehicle itself could be damaged.

Make sure any additional antennas are re-installed and that the outside mirrors are fully folded out again when you leave the automatic car wash.

To avoid damage to your vehicle, observe the following before using an automatic car wash:

- the side windows and the sliding window are completely closed.
- the blower for ventilation and heating is switched off.
- the windshield wiper switch is in position **0**.

If the vehicle is very dirty, wash off excess dirt before cleaning the vehicle in an automatic car wash.

- ⓘ Removing the wax from the windshield and the wiper rubbers after washing the vehicle, will help avoid smearing and reduce wiper noise.

### Notes on using a power washer

**⚠ WARNING** Risk of an accident when using power washers with round-spray nozzles

The water jet can cause externally invisible damage.

Components damaged in this way may unexpectedly fail.

- ▶ Do not use a power washer with round-spray nozzles.
- ▶ Have damaged tires or chassis parts replaced immediately.

Never use a power washer in the vehicle interior. The amount of water accumulated by the pressure the power washer generates and the associated spray could cause considerable damage to the vehicle.

To avoid damage to your vehicle, observe the following when using a power washer:

- Maintain a distance of at least 11.8 in (30 cm) to the vehicle when using 25° flat-spray nozzles and concentrated-power jets and observe the information in the equipment manufacturer's operator's manual.
- Do not direct the nozzle of the power washer directly at sensitive parts such as tires, gaps, electrical components, batteries, lights and ventilation louvers.
- Maintain a minimum distance of 19.7 in (50 cm) from a reversing camera.

### Washing the vehicle by hand

Observe the legal requirements. For example, in a number of countries, washing by hand is permitted only in specially designated wash bays. In this case, make sure that a specially designated wash bay is used for washing by hand.

- ▶ Use a mild cleaning product, e.g. car shampoo.
- ▶ Wash the vehicle with lukewarm water and a soft car sponge. When doing so, do not expose the vehicle to direct sunlight.
- ▶ Carefully spray the vehicle with water and dry off with a chamois. Be careful not to point the water jet directly towards the air inlet grilles. Do not run the blower.
- ▶ Do not let the cleaning product dry on the paintwork.

At the onset of winter, remove all traces of road salt deposits carefully and as soon as possible.

### Notes on paintwork care

**!** **NOTE** Paintwork damage and corrosion due to inadequate care

Failure to promptly and thoroughly remove dirt from bird droppings or other residue could result in paintwork damage and corrosion at a later date.

▶ Clean dirt off paint and matte finish thoroughly and as soon as possible.

Observe the notes on cleaning and care to avoid paintwork damage.

### Paint

- Insect remnants: soak with insect remover and then wipe the treated areas clean.
- Bird droppings: soak with water and then wipe the treated areas clean.
- Tree resin, oils and greases: remove by rubbing gently with a cloth soaked in surgical spirit or lighter fluid.
- Coolant and brake fluid: remove with a damp cloth and clean water.
- Tar stains: use tar remover.
- Wax: use silicone remover.
- Do not attach stickers, films or similar materials.
- Remove any staining as soon as possible.

Observe the following notes:

	Notes on cleaning and care	Preventing damage to the vehicle
<b>Wheels/rims</b>	Use water and acid-free wheel cleaner.	<ul style="list-style-type: none"> <li>• Do not use acidic alloy wheel cleaners to remove brake dust. Otherwise, wheel bolts and brake components could become damaged.</li> <li>• To avoid corrosion of brake discs and pads, drive for a few minutes after cleaning before parking the vehicle. The brake discs and pads will warm up and dry out.</li> </ul>
<b>Windows</b>	Clean windows inside and outside with a damp cloth and with a cleaning agent recommended for Mercedes-Benz.	Do not use dry cloths or abrasive or solvent-based cleaning agents to clean the insides of windows.

### Matte finish

- Use only care products approved for Mercedes-Benz.
- Do not polish the vehicle and light-alloy wheels.
- Use only car washes that comply with the latest engineering standards. If in doubt, always consult the car wash operator, in particular regarding whether the car wash is suitable for cleaning and care of matte paint finishes.
- Do not use a car wash program with a final hot wax treatment.
- Do not use paint cleaners, buffing or polishing products, gloss preservers, e.g. wax.
- Always have paintwork repairs carried out at a qualified specialist workshop.

### Notes on the care for vehicle parts

**!** **WARNING** Risk of entrapment if the windshield wipers are switched on while the windshield is being cleaned

If the windshield wipers are set in motion while you are cleaning the windshield or wiper blades, you can be trapped by the wiper arm.

▶ Always switch off the windshield wipers and the vehicle before cleaning the windshield or wiper blades.

	Notes on cleaning and care	Preventing damage to the vehicle
<b>Wiper blades</b>	With the wiper blades folded out, carefully clean them with a damp cloth.	Do not clean the wiper blades too often.
<b>Exterior lighting</b>	Clean the lenses with a wet sponge and mild cleaning agent (e.g. car shampoo).	Use only cleaning agents or cloths suitable for plastic lenses.
<b>Sensors</b>	Clean the sensors in the front and rear bumpers and in the radiator grill with a soft cloth and car shampoo.	When using a power washer, keep a minimum distance of 11.8 in (30 cm).
<b>Rear view camera</b>	Use clean water and a soft cloth to clean the camera lens.	Do not use a power washer.
<b>Trailer hitch</b>	<ul style="list-style-type: none"> <li>Remove traces of rust on the ball (e.g. with a wire brush).</li> <li>Remove dirt with a lint-free cloth.</li> <li>After cleaning, lightly oil or grease the ball head.</li> <li>Observe the notes on care in the trailer hitch manufacturer's Operator's Manual.</li> </ul>	Do not clean the ball neck with a power washer or solvent.
<b>Sliding door</b>	<ul style="list-style-type: none"> <li>Remove foreign objects from the vicinity of the contact plates and contact pins of the sliding door.</li> <li>Clean the contact plates and contact pins with a mild cleaning agent and a soft cloth.</li> </ul>	Do not oil or grease the contact plates or the contact pins.
<b>aluminum side boards</b>	<ul style="list-style-type: none"> <li>Brush down the aluminum side boards with water and a neutral or mild alkaline cleaning agent.</li> </ul>	Do not use abrasive cleaning agents to clean the side boards.

### Notes on the cleaning and care of the interior

**⚠ WARNING** Risk of injury from plastic parts breaking off after the use of solvent-based care products

Care and cleaning products containing solvents can cause surfaces in the cockpit to become porous. When the airbags are deployed, plastic parts may break away.

- ▶ Do not use any care or cleaning products containing solvents to clean the cockpit.

**⚠ WARNING** Risk of injury or fatal injuries from bleached seat belts

Bleaching or dyeing seat belts can severely weaken them.

This can, for example, cause seat belts to tear or fail in an accident.

- ▶ Never bleach or dye seat belts.

**! NOTE** Damage to property due to incorrect leather care

The steering wheel, seat covers and other parts of the vehicle interior can be made of leather.

Leather becomes brittle and can crack if it is incorrectly cared for or cleaned.

- ▶ If it gets dirty, thoroughly wipe it with a damp cloth (water or mild soapy water) or use leather care agents or cleaners that have been recommended and approved by Mercedes-Benz. Then wipe it over again with a dry cloth.
- ▶ Do not use a microfiber cloth for cleaning.

- ▶ Do not soak the leather.
- ▶ Do not use cleaning agents containing solvents such as tar remover or wheel cleaner, polishes or waxes.

**!** **NOTE** Property damage due to disinfectants

The interior includes a number of sensitive surfaces such as displays, plastics and leather.

Disinfectants can contain alcohol and other substances that penetrate and damage surfaces. Technology behind buttons and displays can also be damaged.

- ▶ Do not use disinfectant on interior surfaces.

To prevent damage to the vehicle, observe the following notes for cleaning and care:

#### Seat belts

- Clean with lukewarm soapy water.
- Do not use chemical cleaning agents.
- Do not dry seat belts by heating them to over 176°F (80°C) or exposing them to direct sunlight.

#### Instrument cluster

- Clean the surfaces carefully with a microfiber cloth and acrylic glass care product.
- Do not use any other agents.

#### Display

- Switch off the display and let it cool down.
- Clean the surface carefully with a microfiber cloth and a suitable display cleaning product (TFT LCD).
- Do not use any other agents.

#### Digital inside rearview mirror

- Clean the mirror glass with a cloth moistened with glass cleaner.
- Clean the light sensors of the inside rearview mirror with a dry cotton cloth.
- Do not spray the glass cleaner on the mirror glass.
- Do not use any other agents.

#### Plastic trim

- Clean with a damp microfiber cloth.
- If very dirty: use a cleaning agent recommended for Mercedes-Benz.

- Do not attach stickers, films or similar materials.
- Do not allow to come into contact with cosmetics, insect repellent or sun creams.

#### Headliner

- Clean with a brush or dry shampoo.

#### Imitation leather seat covers

- Vacuum up dirt such as crumbs or dust and then use a damp cotton cloth and a 1% soap solution to clean the entire seat cover.
- Use cleaning and care products recommended for Mercedes-Benz.
- Do not use a microfiber cloth.
- Do not use any oil-based cleaning and care products.
- Do not spot-clean.

#### Cloth seat covers

- Vacuum up dirt such as crumbs or dust and then use a damp microfiber cloth and a 1% soap solution to clean the entire seat cover.
- Use cleaning and care products recommended for Mercedes-Benz.
- Do not use any oil-based cleaning and care products.
- Do not spot-clean.

#### Steering wheel and gear or selector lever

- Clean with a damp cloth.

#### Pedals and floor mats

- Clean with a damp cloth.
- Do not use any cleaning and care products.

#### Real wood and trim elements

- Clean with a microfiber cloth.
- Black piano-lacquer look: clean with a damp cloth and soapy water.
- If very dirty: use a cleaning agent recommended for Mercedes-Benz.
- Do not use any cleaning agents, polishes or waxes containing solvents.

#### Vehicle interior

- Clean with a damp cloth.
- Do not use a power washer.
- Allow the vehicle interior to dry completely after cleaning.
- Do not allow liquids to penetrate into gaps or cavities.

**Curtains**

- The curtains may be dry-cleaned only.
- Do not wash the curtains.

## Emergency

### Removing the safety vest

▶ Remove the safety vest from the storage compartment in the driver's door.

- ⓘ Safety vests can also be stored in the storage compartments of the rear doors and the co-driver door.

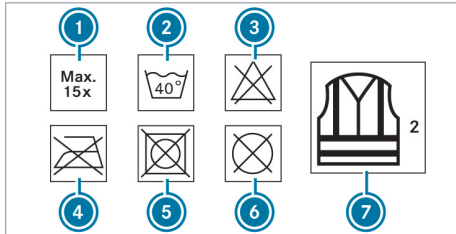

- ① Maximum number of washes
- ② Maximum wash temperature
- ③ Do not bleach
- ④ Do not iron
- ⑤ Do not tumble dry
- ⑥ Do not dry-clean
- ⑦ This is a class 2 vest

The safety vest only fulfills the legally required standards if it is the correct size and is completely closed.

Replace the safety vest if:

- Damaged or if the reflex strips are dirty
- The maximum permitted number of washes is exceeded
- The safety vest's fluorescence has faded

### Removing the first-aid kit (soft sided)

The first-aid kit (soft sided) is located in the stowage compartment in the front passenger door.

▶ Remove the first-aid kit (soft sided) from the stowage compartment.

### Removing the warning lamp

The warning lamp is located in the stowage compartment in the front-passenger door.

▶ Remove the warning lamp from the stowage compartment.

## Emergency Call System

### Information on the emergency call system

**USA only:** Your vehicle is equipped with the Emergency Call System ("eCall"). This feature can help save lives in the event of an accident. eCall in no way replaces assistance provided from dialing 911. eCall only functions in areas where mobile phone coverage is available from the mobile phone network provider. Insufficient network coverage from the wireless service providers may result in an emergency call not being transmitted.

eCall is a standard feature in your Mercedes-Benz vehicle. In order to function as intended, the system relies on the transmission of data detailed in the "Emergency call system data transfer" section that follows (→ page 180). To disable eCall, a customer must visit an authorized Mercedes-Benz Service department to deactivate the vehicle's communication module.

**Deactivation of this module prevents the activation of any and all Mercedes me connect services. After the deactivation of eCall, automatic emergency call and manual emergency call will not be available.**

The vehicle must be switched on before an automatic emergency call can be made.

- ⓘ eCall is activated at the factory.
- ⓘ eCall can be deactivated by an authorized Mercedes-Benz dealer. Please note that in the event ownership of the vehicle is transferred to another owner in its deactivated state, eCall will remain deactivated unless the new owner visits an authorized Mercedes-Benz dealership to reactivate the system.

### Overview of the emergency call system

eCall can help to reduce the time between an accident and the arrival of emergency services at the site of the accident. It helps locate an accident site in places that are difficult to access. However, even if a vehicle is equipped with eCall, this does not mean the system is ON. As such, eCall does not replace dialing 911 in the event of an accident.

An emergency call can be made automatically (→ page 180) or manually (→ page 180). Only make emergency calls if you or others are in need of rescue. Do not make an emergency call in the event of a breakdown or a similar situation.

**Message in the media display:**

**SOS NOT READY:** the vehicle is not on or eCall not available.

During an active emergency call,  appears in the display.

You can find more information on the regional availability of eCall at: <https://www.mercedes-benz-mobile.com/extra/ecall/>

If there is a malfunction of the emergency call system, the speakers, microphone, air bag or the SOS button, for example, are faulty.

You can recognize a malfunction in the emergency call system by the following displays:

- The red SOS NOT READY message appears in the display of the instrument cluster or in the media display.
- The SOS button lights up red continuously.

**Triggering an automatic emergency call****Requirements:**

- The vehicle is switched on.
- The 12 V on-board electrical system battery is sufficiently charged.

If restraint systems such as air bags or Emergency Tensioning Devices have been activated after an accident, eCall may automatically initiate an emergency call.

When the emergency call is made:

- A voice connection is made to the Mercedes-Benz emergency call center.
- A message with accident data is transmitted to the Mercedes-Benz emergency call center.

The Mercedes-Benz emergency call center can transmit the vehicle position data to one of the emergency call centers.

The SOS button in the overhead control panel flashes until the emergency call is finished.

It is not possible to immediately end an automatic emergency call.

If no connection can be made to the emergency services either, a corresponding message appears in the media display.

- ▶ Dial the local emergency number on your mobile phone.

If an emergency call has been initiated:

- Remain in the vehicle if the road and traffic conditions permit you to do so until a voice

connection is established with the emergency call center operator.

- Based on the call, the operator decides whether it is necessary to call rescue teams and/or the police to the accident site.
- If no vehicle occupant answers, an ambulance is sent to the vehicle immediately.

**Triggering a manual emergency call**

- ▶ **Via the SOS button in the overhead control panel:** press the SOS button for at least one second.

- ▶ **Via voice control:** use the MBUX Voice Assistant voice command **Call the Mercedes accident center.**

When the emergency call is made:

- A voice connection is made to the Mercedes-Benz emergency call center.
- A message with accident data is transmitted to the Mercedes-Benz emergency call center.

The Mercedes-Benz emergency call center can transmit the vehicle position data to one of the emergency call centers.

- Remain in the vehicle if the road and traffic conditions permit you to do so until a voice connection is established with the emergency call center operator.
- Based on the call, the operator decides whether it is necessary to call rescue teams and/or the police to the accident site.

If no connection can be made to the public emergency services, a corresponding message appears in the display.

- ▶ Dial the local emergency number on your mobile phone.

**Transmitted data with the emergency call**

Data transmitted by the eCall includes but is not limited to:

- Vehicle's GPS position data
- GPS position data on the route (a few () hundred meters before the incident)
- Direction of travel
- Vehicle identification number
- Vehicle drive type
- Estimated number of people in the vehicle



- Whether the emergency call was initiated manually or automatically
- Time of the accident
- Language setting on the multimedia system

Data transmitted is vehicle information. For any questions about the collection, use and sharing of the eCall system data, please contact MBUSA's Customer Assistance Center at 800-FOR-MERC.

For Canada, please contact MBC's Customer Assistance Center at 1-800-387-0100.

Customer requests for covered information should be submitted via the same channels.

For accident clarification purposes, the following measures can be taken up to an hour after the emergency call has been initiated:

- The current vehicle position can be determined
- A voice connection to the vehicle occupants can be established

## Flat tire

### Notes on flat tires

#### **⚠ WARNING** Risk of accident due to a flat tire

A flat tire strongly impairs the vehicle's driving characteristics, as well as its steering and braking characteristics.

- ▶ Do not drive with a flat tire.
- ▶ Replace the flat tire with the spare wheel. Alternatively, consult a qualified specialist workshop.

In the event of a flat tire, the following options are available depending on your vehicle's equipment:

- You can make a breakdown assistance call using the me button for a service and information call in the overhead control panel (→ page 144).
- Change the wheel (→ page 207).

## Battery

### Notes on the 12 V on-board electrical system battery

#### **⚠ WARNING** Risk of an accident due to work carried out incorrectly on the battery

Work carried out incorrectly on the battery can, for example, lead to a short circuit. This can restrict functions relevant for safety systems and impair the operating safety of your vehicle.

You could lose control of the vehicle in the following situations in particular:

- When braking
  - In the event of abrupt steering maneuvers and/or when the vehicle's speed is not adapted to the road conditions
- ▶ In the event of a short circuit or a similar incident, contact a qualified specialist workshop immediately.
  - ▶ Do not drive on.
  - ▶ Always have work on the battery carried out at a qualified specialist workshop.

- ① Further information on ABS (→ page 118)
- Further information on ESP® (→ page 119)

For safety reasons, Mercedes-Benz recommends that you use only batteries that have been tested and approved for your vehicle by Mercedes-Benz. These batteries provide increased impact protection to prevent vehicle occupants from suffering acid burns should the battery be damaged in an accident.

#### **⚠ WARNING** Risk of explosion due to electrostatic charge

Electrostatic charge can ignite the highly explosive gas mixture in the battery.

- ▶ To discharge any electrostatic charge that may have built up, touch the metal vehicle body before handling the battery.

The highly flammable gas mixture is created while the battery is charging and when jump-starting.

#### **⚠ WARNING** Danger of chemical burns from the battery acid

Battery acid is caustic.

- ▶ Avoid contact with the skin, eyes or clothing.
- ▶ Do not lean over the battery.
- ▶ Do not inhale battery gases.
- ▶ Keep children away from the battery.
- ▶ Immediately rinse battery acid off thoroughly with plenty of clean water and seek medical attention immediately.

 **ENVIRONMENTAL NOTE** Environmental damage due to improper disposal of batteries



Batteries contain pollutants. It is illegal to dispose of them with the household rubbish.



Dispose of batteries in an environmentally responsible manner. Take discharged batteries to a qualified specialist workshop or to a collection point for used batteries.

Observe the safety notes and protective measures when handling batteries.



Risk of explosion



Fire, naked flames and smoking are prohibited when handling the battery. Avoid creating sparks.



Electrolyte or battery acid is corrosive. Avoid contact with the skin, eyes and clothing. Wear suitable protective clothing, in particular gloves, an apron and a safety mask. Immediately rinse electrolyte acid splashes off with clean water. If necessary, seek medical advice.



Wear eye protection.



Keep children at a safe distance.



Observe this Operator's Manual.

Consult a qualified specialist workshop if you wish to leave your vehicle parked up for long periods.

### Notes on the high-voltage battery

**⚠ DANGER** Risk of fire and explosion from excessive internal pressure of the high-voltage battery

In the event of a vehicle fire, flammable gas can escape and ignite.

- ▶ If there is an unusual smell, smoke or burn marks, stop the charging process immediately.
- ▶ Leave the danger zone immediately. Secure the danger area at a sufficient distance.
- ▶ Call the fire service.

In order for the high-voltage battery to achieve the maximum possible service life, it should always be sufficiently charged. Have the battery's charge level checked if you park the vehicle for a long period of time. Exhaustive discharging caused by the vehicle standing idle for lengthy periods can damage the high-voltage battery. If the vehicle is idle for lengthy periods, run it for a few minutes once every four weeks to charge up the high-voltage battery.



Risk of explosion



Fire, naked flames and smoking are prohibited when handling the battery. Avoid creating sparks.



Electrolyte or battery acid is corrosive. Avoid contact with the skin, eyes and clothing. Wear suitable protective clothing, in particular gloves, an apron and a safety mask. Immediately rinse electrolyte acid splashes off with clean water. Consult a doctor if necessary.



Wear eye protection.



Keep children at a safe distance.



Observe this Operator's Manual.

Further information on charging the high-voltage battery (→ page 106).

### Starting assistance and charging the 12 V on-board electrical system battery

- ▶ Have starting assistance provided only by a qualified specialist workshop, e.g. an authorized Mercedes-Benz Center.
- ▶ Have the 12 V on-board electrical system battery charged only at a qualified specialist workshop, e.g. an authorized Mercedes-Benz Center.

### Replacing the 12 V on-board electrical system battery

- ▶ Only have the 12 V on-board electrical system battery replaced at a qualified specialist workshop, e.g. an authorized Mercedes-Benz Center.

### 12-V-auxiliary battery under the front passenger seat or in the engine compartment

- ▶ Only have work on the 12 V auxiliary battery carried out at a qualified specialist workshop, e.g. in a authorized Mercedes-Benz Center.

## Towing or tow-starting

### Permitted towing methods

In the event of a breakdown, Mercedes-Benz recommends that you have the vehicle transported instead of towed.

Use a tow rope or a tow bar when towing with both axles on the ground; other towing methods are not permissible.

If you notice that the vehicle has lost coolant, towing it away is not permitted. Have the vehicle transported.

**⚠ WARNING** Risk of accident due to limited safety-related functions during the towing process

Safety-related functions are limited or no longer available in the following situations:

- The vehicle is switched off.
- The brake system or power steering system is malfunctioning.
- The energy supply or the on-board electrical system is malfunctioning.

When your vehicle is towed away, significantly more effort may be required to steer and brake than is normally required.

- ▶ Use a tow bar.
- ▶ Make sure that the steering wheel can move freely before towing the vehicle away.

**! NOTE** Damage to the vehicle due to towing away incorrectly

- ▶ Observe the instructions and notes on towing away.

**! NOTE** Damage due to automatic braking

When Active Brake Assist or the HOLD function is activated, the vehicle brakes automatically in certain situations.

To avoid damage to the vehicle, deactivate these systems in the following or similar situations:

- ▶ When towing
- ▶ In a car wash

**! NOTE** Damage to drive system due to incorrect maneuvering

If the vehicle is moved rearwards when the drive system has failed, e. g. when pushing or maneuvering, the drive system can be damaged.

- ▶ Move the vehicle rearwards only briefly and slowly.

## Permitted towing methods



## Both axles on the ground

Yes, a maximum of 30 miles (50 km) at 30 mph (50 km/h)



## Rear axle raised

Yes, if the steering wheel is fixed in the center position with a steering wheel lock

- ❗ If the transmission cannot be shifted into position **[N]**, transport the vehicle (→ page 185). A towing vehicle with lifting equipment is required for vehicle transport.
- ❗ If there is damage to the engine cooling system, the vehicle may only be moved with the drive axle raised.

- If the display on the instrument cluster is not working.
- If the  **Towing Not Permitted See Operator's Manual** display message is shown or another display message that indicates a problem.

Transporting the vehicle (→ page 185).  
A towing vehicle with lifting equipment is required to transport the vehicle.

## Towing the vehicle with both axles on the ground

**!** **NOTE** Damage due to towing away at excessively high speeds or over long distances

The drivetrain could be damaged when towing at excessively high speeds or over long distances.

- ▶ A towing speed of 30 mph (50 km/h) must not be exceeded.
- ▶ A towing distance of 30 miles (50 km) must not be exceeded.

- ▶ Observe the notes on permissible towing methods (→ page 183).
- ▶ Make sure that the battery is connected and charged.

If the 12 V on-board electrical system battery is discharged, please note the following points:

- The drive system cannot be started.
  - It is not possible to release or apply the electric parking brake.
  - It is not possible to shift the transmission to position **[N]** or **[P]**.
- ❗ Towing is not permitted in the following cases:
- If the drive system is not switched on.
  - If there is no driver in the vehicle being transported.
  - If the transmission cannot be shifted to position **[N]**.

**!** **WARNING** Risk of accident when towing a vehicle which is too heavy

If the vehicle to be tow-started or towed away is heavier than the permissible gross mass of your vehicle, the following situations can occur:

- The towing eye may become detached.
- The vehicle/trailer combination may swerve or rollover.

▶ Before tow-starting or towing away, check if the vehicle to be tow-started or towed away exceeds the permissible gross mass.

- ▶ Information on the gross vehicle weight rating can be found on the vehicle identification plate (→ page 218).
- ▶ Do not open the driver's door or the front passenger door. Otherwise, the transmission will automatically shift to position **[P]**.
- ▶ Install the towing eye (→ page 185).
- ▶ Secure the towing device.

**!** **NOTE** Damage due to incorrect connection of the tow bar

▶ Only connect the tow rope or tow bar to the towing eyes.

- ▶ Deactivate automatic locking (→ page 43).

- ▶ Do not activate the HOLD function.
- ▶ Deactivate the tow-away alarm (→ page 54).
- ▶ Deactivate Active Brake Assist (→ page 123).
- ▶ Shift the transmission to position **N** (→ page 105).
- ▶ (→ page 117)Release the parking brake.

**!** **NOTE** Damage due to excessive tractive power

If you pull away sharply, the tractive power may be too high and the vehicles could be damaged.

- ▶ Pull away slowly and smoothly.

### Towing the vehicle with the rear axle raised

**!** **WARNING** Risk of accident when towing with the vehicle switched on

When towing with the rear axle raised and the vehicle switched on, ESP® may apply the brakes on the front axle in an uncontrolled manner.

The vehicle may skid.

- ▶ Switch the vehicle off before towing with the rear axle raised.

**!** **NOTE** Damage if the vehicle is switched on

If you leave the vehicle switched on while towing it with the rear axle raised, intervention by ESP® may damage the brake system.

- ▶ Switch off the vehicle.

- ▶ Observe the notes on permissible towing methods (→ page 183).
- ▶ Switch on the hazard warning light system (→ page 73).
- ▶ Move the front wheels to the straight-ahead position.
- ▶ Release the parking brake (→ page 117).
- ▶ Switch off the vehicle.

### Loading the vehicle for transport

- ▶ Observe the notes on permissible towing methods (→ page 183).
- ▶ Connect the tow bar to the towing eye to load the vehicle.

- ▶ Load the vehicle onto the transporter.
- ▶ Use the parking brake to secure the vehicle against rolling away.
- ▶ Only secure the vehicle by the wheels.

### Towing eye storage location

The towing eye is located in the vehicle tool kit in the front passenger footwell (→ page 185).

### Installing/removing the towing eye

#### Installing the front towing eye

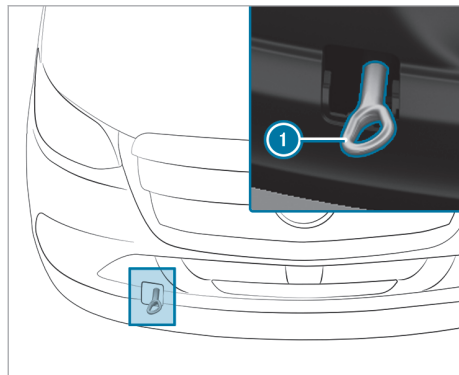

- ▶ Press the top of the cover and remove the cover.
- ▶ Screw in towing eye ① as far as it will go.

#### Removing the front towing eye

- ▶ Unscrew towing eye ① counter-clockwise.
- ▶ Insert the cover with the tabs at the top and push in at the bottom until the cover engages.

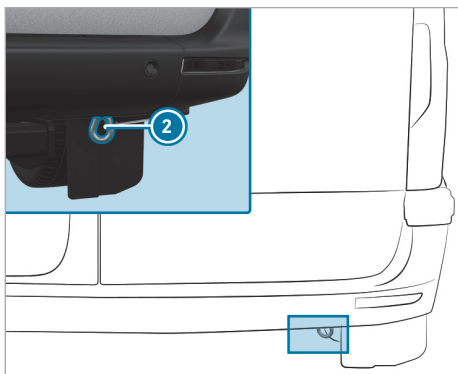

Rear towing eye

- ① Rear towing eye ② is permanently attached to the vehicle.

**!** **NOTE** Damage to the vehicle due to incorrect use of the towing eye or trailer hitch

When a towing eye or trailer hitch is used to recover a vehicle, the vehicle may be damaged in the process.

- ▶ Only use the towing eye or trailer hitch to tow away or tow start the vehicle.
- ▶ Do not use the towing eye or trailer hitch to tow the vehicle during recovery.

### Tow-starting the vehicle

- ▶ If the drive system does not start, have the vehicle transported to the nearest qualified specialist workshop, e.g. an authorized Mercedes-Benz Center.
- ▶ The drive system cannot be started by tow-starting. Do not attempt to tow-start the vehicle.

### Electrical fuses

#### Notes on electrical fuses

**⚠** **WARNING** Risk of accident and injury due to overloaded lines

If you manipulate or bridge a faulty fuse or if you replace it with a fuse with a higher amperage, the electric line could be overloaded.

This could result in a fire.

- ▶ Always replace faulty fuses with specified new fuses containing the correct amperage.

**!** **NOTE** Damage due to incorrect fuses

Electrical components or systems could be damaged by incorrect fuses.

- ▶ Only use fuses which have been approved by Mercedes-Benz and which have the correct fuse rating.

The electrical fuses in your vehicle isolate defective circuits. If a fuse blows, all the components on the circuit and their functions will cease to operate.

Blown fuses must be replaced with fuses of an equivalent specification, which you can determine by the color and fuse rating. The fuse allocation chart and further information on the electric fuses and relays can be found in the "Fuse allocation chart" supplement.

**!** **NOTE** Damage or malfunctions caused by moisture

Moisture may cause damage to the electrical system or cause it to malfunction.

- ▶ When the fuse box is open, make sure that no moisture can enter the fuse box.
- ▶ When closing the fuse box, make sure that the seal of the lid is positioned correctly on the fuse box.

If the new fuse which has been inserted also blows, have the cause traced and rectified at a qualified specialist workshop.

Make sure of the following before replacing a fuse:

- The vehicle is secured such that it does not roll away.
- All electrical consumers are switched off.
- The vehicle is switched off.

The fuses are located in various fuse boxes:

- Fuse box in the co-driver footwell (→ page 187)
- Fuse box in the seat base of the driver's seat (→ page 187)

### Opening the fuse box in the seat base of the driver's seat

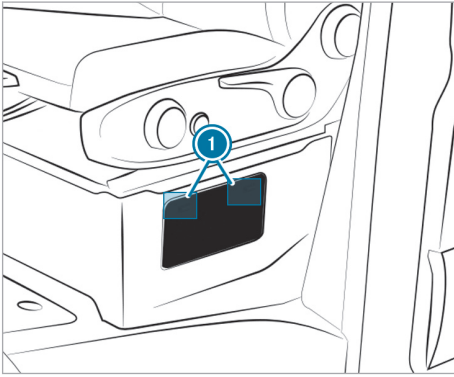

- ▶ **To open:** press down and unclip fasteners ❶ on the cover.
- ▶ Remove the cover.
- ▶ **To close:** press the cover firmly into the seat base until fasteners ❶ clip in.

### Opening and closing the fuse box in the co-driver's footwell

#### Opening the fuse box

- ▶ Unlocking and removing the stowage compartment cover in the co-driver's footwell (→ page 187).

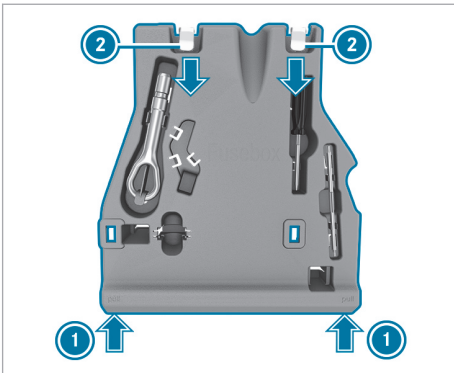

Example: vehicle tool kit insert

- ▶ Lift the insert at marked positions ❶.
- ▶ Pull the insert out of clips ❷.

#### Closing the fuse box

- ▶ Slide the insert into clips ❷.
- ▶ Close the insert by pressing on marked positions ❶.
- ▶ Put on the stowage compartment cover in the co-driver's footwell and lock it (→ page 187).

### Vehicle tool kit

#### Information on the vehicle tool kit

The vehicle tool kit is located in the stowage compartment in the footwell on the front passenger side (→ page 187).

The vehicle tool kit contains:

- a towing eye
- a screwdriver with Torx®, Phillips and slotted heads

The vehicle tool kit may also contain the following, for example:

- an open-end wrench
- a wheel wrench
- a release tool for the parking lock
- an insert bit
- a socket wrench

#### Unlocking and removing the stowage compartment cover

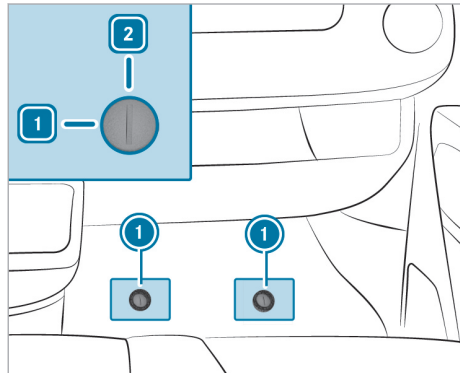

- ▶ Remove the rubber mat from the co-driver's footwell.
- ▶ **To unlock:** turn quick-release fastener ❶ counter-clockwise to position ❶.
- ▶ Slightly raise and pull out the cover.

### Inserting and locking the cover

- ▶ Slide in the cover and press it downwards.
- ▶ Press down quick-release fastener ① until it engages.
- ▶ **To lock:** turn quick-release fastener ① clockwise to position ②.

### Removing the vehicle tool kit

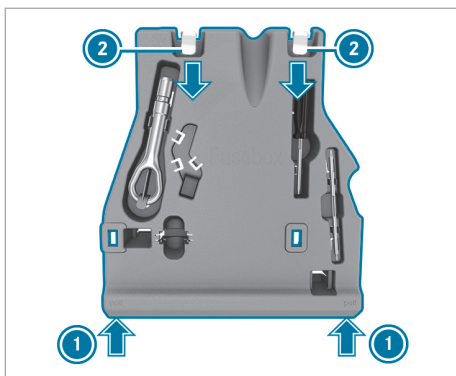

Example: vehicle tool kit insert

- ▶ Lift the insert at marked positions ①.
- ▶ Pull the insert out of clips ②.

### Storing the vehicle tool kit

- ▶ Slide the insert into clips ②.
- ▶ Close the insert by pressing on marked positions ①.

## Hydraulic jack

### Information on the hydraulic jack

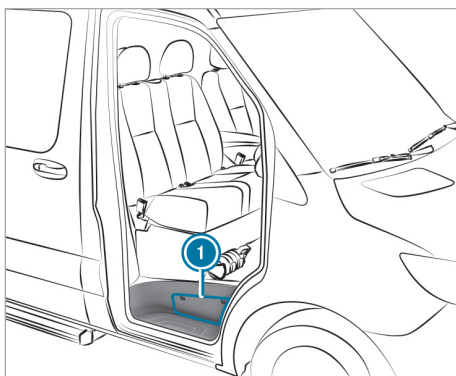

The hydraulic jack is located in side compartment ① above the co-driver door step.

The jack has a maximum weight of 16.5 lbs (7.5 kg) depending on the vehicle's equipment. You will find the maximum load capacity of the jack stated on the adhesive label attached to the jack. If there is a malfunction, please contact a qualified specialist workshop.

Jack maintenance:

- Clean and grease all moving parts after use.
- Extend and retract the pistons fully every six months.

### Removing the pump lever rod and the jack

Requirements:

- The co-driver door is open.

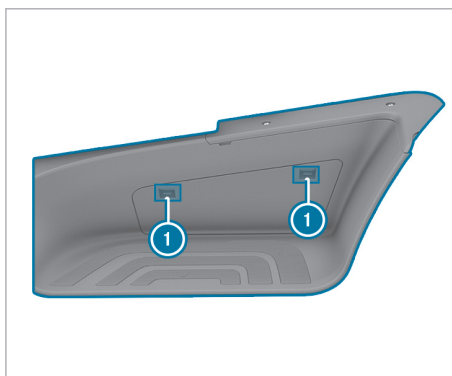

- ▶ **To open:** press down and unclip fasteners ① on the cover.
- ▶ Remove the cover.
- ▶ Pull out the holder completely and place it on the step.



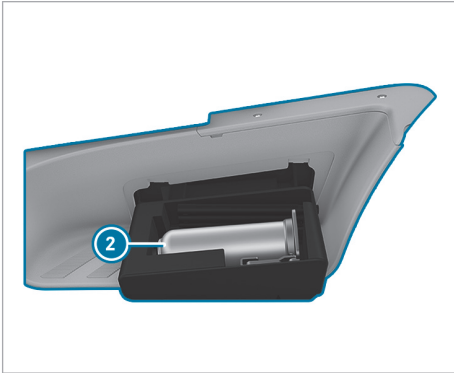

- ▶ Remove jack ② and the pump lever rod.
- ▶ **To close:** press the cover firmly so that fasteners ① engage.

### Information on noise or unusual driving characteristics

While driving, pay attention to vibrations, noises and unusual driving characteristics, e.g. pulling to one side. This may indicate damage to the wheels or tires. If you suspect that a tire is defective, reduce your speed. Stop the vehicle as soon as possible to check if wheels and tires have been damaged or are no longer functioning properly. Hidden tire damage could also be causing the unusual driving characteristics. If no signs of damage can be detected, have the tires and wheels checked at a qualified specialist workshop.

### Notes on regularly inspecting wheels and tires

#### **⚠ WARNING** Risk of injury through damaged tires

Damaged tires can cause tire pressure loss.

- ▶ Check the tires regularly for signs of damage and replace any damaged tires immediately.

Check the wheels and tires of your vehicle for damage regularly, i.e. at least every two weeks, as well as after driving off-road or on rough roads. Damaged wheels can cause a loss of tire pressure.

Look out for the following types of damage, for example:

- cuts in the tires
- punctures in the tires
- tears in the tires
- bulges on tires
- deformation or severe corrosion on wheels

#### **⚠ WARNING** Risk of hydroplaning due to insufficient tire tread

Insufficient tire tread will result in reduced tire grip.

- ▶ Thus, you should regularly check the tread depth and the condition of the tread across the entire width of all tires.

Minimum tread depth for:

- Summer tires:  $\frac{1}{8}$  in (3 mm)
- M+S tires:  $\frac{1}{4}$  in (4 mm)

- ▶ For safety reasons, replace the tires before the legally prescribed limit for the minimum tread depth is reached.

Conduct the following checks regularly on all wheels, at least once a month or as required, e.g. before a long journey or when driving off-road:

- check the tire pressure (→ page 192)

- check the valve caps

Valves must be protected from moisture and dirt with valve caps specifically approved by Mercedes-Benz for your vehicle.

- visually inspect the tread depth and the tire contact surface across the whole tire width

The minimum tread depth for summer use is  $\frac{1}{8}$  in (3 mm) and for winter use  $\frac{1}{4}$  in (4 mm).

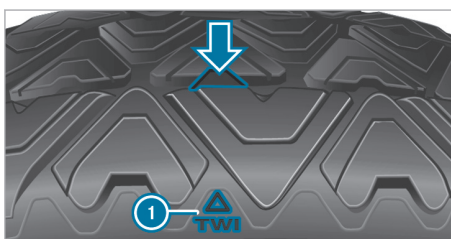

Markings ① show in which places the bar indicators (arrow) are integrated into the tire tread. They are visible as soon as the tread depth is approximately  $\frac{1}{16}$  in (1.6 mm).

### Information on driving with summer tires

At temperatures below 50 °F (10 °C) summer tires significantly lose elasticity and thus traction and stopping power. Change the tires on your vehicle to M+S tires. Using summer tires at very cold temperatures could cause cracks to form, thereby damaging the tires permanently. Mercedes-Benz cannot accept responsibility for this type of damage.

Always observe the maximum permissible speed specified for the mounted summer tires (→ page 202).

After you mount the summer tires:

- restart the tire pressure monitoring system (→ page 196)
- check the tire pressure (→ page 192)

### Information on M+S tires

**⚠ WARNING** Risk of accident caused by incorrect wheel and tire dimensions

The wheel or tire sizes and the tire type of the emergency spare wheel or spare wheel and the wheel to be replaced may differ. The emergency spare wheel or spare wheel can significantly impair driving characteristics of the vehicle.

To prevent hazardous situations:

- ▶ Drive carefully.
- ▶ Never install more than one emergency spare wheel or spare wheel that differs in size.
- ▶ Only use an emergency spare wheel or spare wheel briefly.
- ▶ Do not deactivate ESP®.
- ▶ Have the emergency spare wheel or spare wheel of a different size replaced at the nearest qualified specialist workshop. The new wheel must have the correct dimensions.

**⚠ WARNING** Risk of an accident due to insufficient tire tread

M+S tires with a tread depth of less than  $\frac{1}{8}$  in (4 mm) are not suitable for use in winter and do not provide sufficient grip.

- ▶ M+S tires with a tread depth of less than  $\frac{1}{8}$  in (4 mm) must be replaced immediately.

At temperatures below 50 °F (10 °C) use winter tires or all-season tires marked M+S.

Only winter tires bearing the  snowflake symbol in addition to the M+S marking provide the best possible grip in wintry road conditions.

Only these tires allow driving safety systems such as ABS and ESP® to also function optimally in winter. These tires have been developed specifically for driving in snow.

Use M+S tires of the same make and tread pattern on all wheels to maintain safe handling characteristics.

Observe the maximum permissible speed specified for the mounted M+S tires (→ page 202).

If you install M+S tires that have a lower maximum permissible speed than the maximum design speed of the vehicle, affix an appropriate informa-

tion label in the driver's field of vision. You can obtain this at a qualified specialist workshop.

After you mounted the M+S tires, do the following:

- restart the tire pressure monitoring system (→ page 196)
- check the tire pressure (→ page 196)

### Notes on snow chains

**⚠ WARNING** Risk of accident due to incorrectly installed snow chains

If you have installed snow chains on the front wheels, they may drag against the vehicle body or chassis components.

- ▶ Never install snow chains on the front wheels.
- ▶ Only install snow chains on the rear wheels in pairs.

**⚠ WARNING** Risk of accident due to unsuitable snow chains

Commercially available snow chains can come loose and damage chassis components or brake hoses.

- ▶ Only install snow chains that have been approved by Mercedes-Benz for these tires.

For safety reasons, Mercedes-Benz recommends that you only use snow chains that have been tested and approved. You can obtain information about snow chains from any qualified specialist workshop.

**⚠ WARNING** Risk of accident due to snow chains breaking

If you drive too fast with snow chains, they can break, injure other persons, and damage the vehicle.

- ▶ Observe the maximum permissible speed for operation with snow chains.

**! NOTE** Damage to the wheel trim from mounted snow chains

If snow chains are mounted to steel wheels, the wheel trims can be damaged.

- ▶ Remove the wheel trims of steel wheels before mounting snow chains.

Observe the following notes when using snow chains:

- Snow chains are only permissible for certain wheel/tire combinations. You can obtain information on this matter at a qualified specialist workshop.
  - For safety reasons, only use snow chains that have been specifically approved for your vehicle by Mercedes-Benz, or snow chains with the same quality standard.
  - The snow chains must be retightened after driving approximately 0.6 miles (1 km). This is the only way to ensure the snow chains are optimally installed with clearance to adjacent components.
  - Use snow chains only when the road surface is completely snow-covered. Remove the snow chains as soon as possible when you come to a road that is not snow-covered.
  - Local regulations may restrict the use of snow chains. Observe the applicable regulations before installing snow chains.
  - If snow chains are installed, the maximum permissible speed is 30 mph (50 km/h).
-  You can deactivate ESP® to start off (→ page 120). This allows the wheels to spin, achieving an increased propulsive force.

## Tire pressure

### Notes on tire pressure

#### **WARNING** Risk of accident due to insufficient or excessive tire pressure

Underinflated or overinflated tires pose in particular the following risks:

- The tires can burst.
  - The tires can wear excessively and/or unevenly.
  - The driving characteristics as well as the steering and braking characteristics may be greatly impaired.
-  Comply with the recommended tire pressures and check the tire pressure of all tires, including the spare wheel, regularly:
- Monthly
  - When the load changes

- Before embarking on a longer journey
  - If operating conditions change, e.g. off-road driving
-  Adjust the tire pressure, if necessary.

Driving with tire pressure that is too high or too low can:

- shorten the service life of the tires
- contribute to tire damage
- adversely affect driving characteristics and thus driving safety, e.g. due to hydroplaning.

#### **WARNING** Risk of accident due to too low a tire pressure

Tires with pressure that is too low can overheat and burst as a consequence.

In addition, they also suffer from irregular wear, which can significantly impair the braking properties and the handling characteristics.

-  Avoid excessively low tire pressure.

tire pressure which is too low can lead to:

- tire defects as a result of overheating
- impaired handling characteristics
- uneven wear
- increased fuel consumption

#### **WARNING** Risk of accident due to too high a tire pressure

Tires with excessively high pressure can burst.

In addition, they also suffer from irregular wear, which can significantly impair the braking properties and the handling characteristics.

-  Avoid excessively high tire pressures.

tire pressure which is too high can lead to:

- increased braking distance
- impaired handling characteristics
- uneven wear
- impaired driving comfort
- susceptibility to damage

#### **WARNING** Risk of accident due to repeated pressure drop in the tires

The wheels, valves or tires could be damaged.

Too low a tire pressure can lead to the tires bursting.

- ▶ Examine the tires for foreign objects.
- ▶ Check whether the tire has a puncture or the valve has a leak.
- ▶ If you are unable to rectify the damage, contact a qualified specialist workshop.

You can find information on recommended tire pressure for the vehicle's factory-installed tires on the following labels:

- tire and loading information and tire pressure table on the B-pillar of your vehicle (→ page 197).

Observe the maximum tire pressure (→ page 202).

Use a suitable pressure gauge to check the tire pressure. The outward appearance of a tire does not permit any reliable conclusion about the tire pressure.

 **ENVIRONMENTAL NOTE** Environmental damage due to insufficient or excessive tire pressure

Overinflating or underinflating your tires will shorten their service life.

- ▶ Check the tire pressure regularly, but at least every 14 days.

**Vehicles with a tire pressure monitoring system:** you can also check the tire pressure via the instrument cluster.

Only check tire pressure when the tires are cold. Conditions for cold tires:

- The vehicle has been parked with the tires out of direct sunlight for at least three hours.
- The vehicle has travelled less than 1 mile (1.6 km).

A rise in the tire temperature of 18°F (10°C) increases the tire pressure by approx. 10 kPa (0.1 bar/1.5 psi). Take this into account when checking the tire pressure of warm tires.

The tire pressure recommended for increased load/speed in the tire pressure table may affect the ride comfort.

 **WARNING** Risk of accident due to unsuitable accessories on tire valves

If you mount unsuitable accessories onto tire valves, the tire valves may be overloaded and

malfunction, which can cause tire pressure loss.

- ▶ Only screw standard valve caps or valve caps specifically approved by Mercedes-Benz for your vehicle onto the tire valve.

**Notes on trailer operation**

The applicable tire pressure for the tires of the rear axle is always the recommended tire pressure for a full load.

Overview of the tire pressure table

The tire pressure table can be found on the B-pillar on the driver's side.

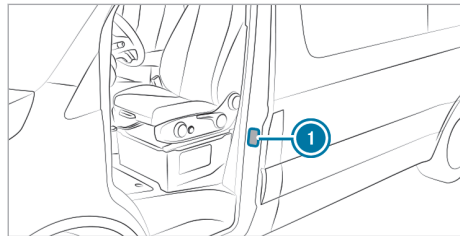

1 tire pressure table B-pillar

i The data shown in the images is example data.

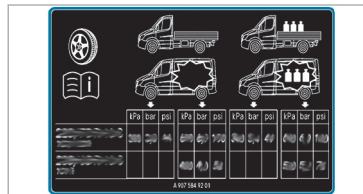

The tire pressure table shows the recommended tire pressure for the tires installed on this vehicle at the factory. The recommended tire pressures are valid for cold tires and different vehicle load conditions.

If one or more tire sizes precede a tire pressure, the tire pressure information following is only valid for those tire sizes.

If the preceding tire sizes are supplemented by the  symbol, the tire pressure information following shows alternative tire pressures.

The load conditions "partially laden" and "fully laden" are defined in the table by varying weights.

Some tire pressure tables only show the rim diameter instead of the complete tire size, e.g. R16. The

rim diameter is part of the tire size and can be found on the side wall of the tire (→ page 202).

#### Front axle tire pressures on vehicles with rear wheel drive and single tires

Max. front axle load 4101 lbs (1860 kg)

tires/disk wheel	Load condition	Max. front axle load 4101 lbs (1860 kg)
LT245/75 R16 120/116Q	Fully laden	320 kPa (3.2 bar/46 psi)

#### Front axle tire pressures on vehicles with rear wheel drive and single tires

Max. front axle load 4409 lbs (2000 kg)

tires/disk wheel	Load condition	Max. front axle load 4409 lbs (2000 kg)
LT245/75 R16 120/116Q	Fully laden	360 kPa (3.6 bar/52 psi) <sup>1)</sup>

<sup>1)</sup> Only valid for vehicles with a long wheelbase 171 in (4350 mm) and a permissible gross mass of over 7716 lbs (3.5 t).

#### rear axle tire pressures on vehicles with rear wheel drive and single tires

Max. rear axle load 5357 lbs (2430 kg)

tires/disk wheel	Load condition	Max. rear axle load 5357 lbs (2430 kg)
LT245/75 R16 120/116Q	Fully laden	480 kPa (4.8 bar/70 psi)
LT245/75 R16 120/116Q	Partially laden <sup>2)</sup>	440 kPa (4.4 bar/64 psi) <sup>2)</sup>

<sup>2)</sup> It is only permissible to use this reduced tire pressure if it can be guaranteed by weighing the vehicle that the rear axle load of 4960 lbs (2250 kg) will not be exceeded. In case of doubt, inflate to 480 kPa (4.8 bar/70 psi).

Be sure to also observe the following further related subjects:

- Notes on tire pressure (→ page 192)
- Tire and Loading Information placard (→ page 197)
- Maximum tire pressure (→ page 202)

### Tire pressure monitoring system

#### Function of the tire pressure monitoring system

**⚠ DANGER** Risk of accident due to incorrect tire pressure

Each tire, including the spare (if provided), should be checked monthly when cold and inflated to the inflation pressure recommended by the vehicle manufacturer on the vehicle placard or tire inflation pressure label. (If your vehicle has tires of a different size than the size indicated on the vehicle placard or tire inflation pressure label, you should determine the proper tire inflation pressure for those tires.)

As an added safety feature, your vehicle has been equipped with a tire pressure monitoring system (TPMS) that illuminates a low tire pres-

sure telltale when one or more of your tires is significantly under-inflated. Accordingly, when the low tire pressure telltale illuminates, you should stop and check your tires as soon as possible, and inflate them to the proper pressure. Driving on a significantly under-inflated tire causes the tire to overheat and can lead to tire failure. Under-inflation also reduces fuel efficiency and tire tread life, and may affect the vehicle's handling and stopping ability. Please note that the TPMS is not a substitute for proper tire maintenance, and it is the driver's responsibility to maintain correct tire pressure, even if under-inflation has not reached the level to trigger illumination of the TPMS low tire pressure telltale.

Your vehicle has also been equipped with a TPMS malfunction indicator to indicate when the system is not operating properly. The TPMS malfunction indicator is combined with the low tire pressure telltale. When the system detects a malfunction, the telltale will flash for approximately one minute and then remain continuously illuminated. This sequence will continue upon subsequent vehicle start-ups as long as the malfunction exists.

When the malfunction indicator is illuminated, the system may not be able to detect or signal low tire pressure as intended. TPMS malfunctions may occur for a variety of reasons, including the installation of replacement or alternate tires or wheels on the vehicle that prevent the TPMS from functioning properly.



The system checks the pressures and temperatures of the tires installed on the vehicle by means of a tire pressure sensor.

New tire pressure sensors, e.g. in winter tires, will automatically be calibrated during the first journey.

The tire pressure and the tire temperature will appear on the display of the instrument cluster (→ page 139).

If there is a substantial loss of tire pressure, a warning will be issued:

- via display messages (→ page 238)
- via the  warning lamp on the instrument cluster (→ page 253)

It is the driver's responsibility to set the tire pressure to the recommended cold tire pressure suitable for the operating situation. Set the tire pressure for cold tires using a tire pressure gauge.

Note that the tire pressure monitoring system must first learn the correct tire pressure for the current operating situation.

In most cases, the tire pressure monitoring system will automatically update the new reference values after you have changed the tire pressure. However, you can also update the reference values by restarting the tire pressure monitoring system manually (→ page 196).

### System limits

The system may be impaired or inoperative in the following situations:

- if the tire pressure has been set incorrectly
- if there is a sudden pressure loss caused, for example, by a foreign object penetrating the tire
- if there is a malfunction caused by another radio signal source
- if there is a change in tire size

Bear in mind the following related topic:

- Notes on tire pressure (→ page 192)

### ■ Checking the tire pressure with the tire pressure monitoring system

#### Requirements

- The vehicle is switched on.

Instrument cluster:

↳ Service ▶▶ Tires

One of the following indicators will appear:

- The current tire pressures and temperatures at the individual wheels.

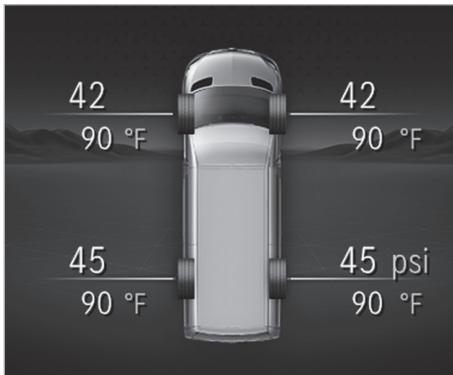

Instrument cluster display

- **Tire pressure will be displayed after driving a few minutes.:** The calibration process for the system is not yet complete. The tire pressures are already being monitored.

▶ Compare the tire pressure with the recommended tire pressure for the current operating status (→ page 193). Observe the notes on tire temperature (→ page 192).

ⓘ The values displayed on the instrument cluster may deviate from those of the tire pressure gauge, as they refer to sea level. At high altitudes, the tire pressure value indicated by a pressure gauge will be higher than those shown on the instrument cluster display. If this is the case, do not reduce the tire pressure.

Bear in mind the following related topic:

- Notes on tire pressure (→ page 192)

### ■ Restarting the tire pressure monitoring system

#### Requirements

- The recommended tire pressure is correctly set for the respective operating condition on each of the wheels (→ page 192).
- **Restart the tire pressure monitoring system in the following situations:**
  - The tire pressure has changed.
  - The wheels or tires have been changed or newly installed.

Instrument cluster:

↳ Service ▶▶ Tires

▶ Scroll down on the menu.

A message reading **Use current pressures as new reference values?** will appear on the instrument cluster.

▶ Confirm the message to initiate a restart.

A message reading **Tire Press. Monitor Restarted** will appear on the instrument cluster.

Current warning messages will be deleted and the yellow  warning lamp will go out.

Once you have been driving for a few minutes, the system will check whether the current tire pressure are within the specified range. The current tire pressures will then be accepted as reference values and monitored.



Bear in mind the following related topic:

- Notes on tire pressure (→ page 192)

**Radio equipment approval of the tire pressure monitoring system**

Country	Radio equipment approval number
Canada	IC: 4008C-TSSRE4A Operation is subject to the following two conditions: (1) this device may not cause harmful interference, and (2) this device must accept any interference received, including interference that may cause undesired operation.
Mexico	Model: TSSRE4A & TSSSG4G6, IFETEL: RLVHUTS17-0806
USA	FCC ID: YGOTSSRE4A This device complies with Part 15 of the FCC Rules. Operation is subject to the following two conditions: (1) this device may not cause harmful interference, and (2) this device must accept any interference received, including interference that may cause undesired operation. <b>WARNING:</b> Any changes or modification not expressly approved by the party responsible for compliance could void the user's authority to operate this equipment.

**Loading the vehicle**

**Tire and Loading Information placard**

**⚠ WARNING** Risk of an accident when driving with an overloaded tire

Overloaded tires may overheat and burst. Overloaded tires can impair the steering and handling characteristics and lead to brake failure.

- ▶ Observe the load rating of the tires.
- ▶ The load rating must be at least half the permissible axle load of the vehicle.
- ▶ Mercedes-Benz recommends you use the load-bearing index, which is given in the vehicle documents.
- ▶ Never overload the tires by exceeding the maximum load.

Only vehicles with a gross vehicle weight of less than 10,000 lbs (4,536 kg) have a Tire and Loading Information placard on the B-pillar on the driver's side.

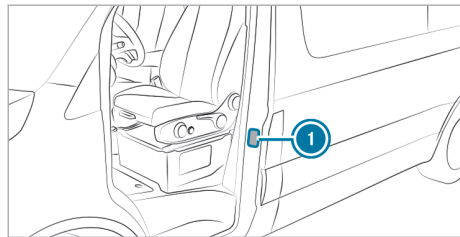

1 Tire and Loading Information placard

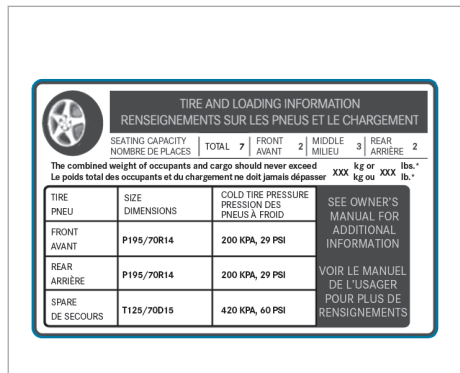

i The data shown in the illustration are sample data.

The Tire and Loading Information placard shows:

- The maximum number of seats indicates the maximum number of occupants permitted to travel in the vehicle.
- The maximum permissible load equals the gross weight of all vehicle occupants, the luggage and any payload.
- The recommended tire pressure for cold tires. The recommended tire pressures apply to the maximum permissible load and up to the maximum permissible vehicle speed.

Also observe the following information:

- The information about permissible weights on the vehicle identification plate (→ page 218)
- The information about tire pressures in the tire pressure table (→ page 193)

Additional related subjects:

- Determining the maximum payload (→ page 198)
- Notes on tire pressure (→ page 192)

### Steps to determine the correct load limit

The following steps have been developed as required of all manufacturers under Title 49, Code of U.S. Federal Regulations, Part 575 in accordance with the "National Traffic and Motor Vehicle Safety Act of 1966."

- ▶ **Step 1:** Locate the statement, "The combined weight of occupants and cargo should never exceed XXX kg or XXX lbs." on the Tire and Loading Information placard of your vehicle.
- ▶ **Step 2:** Determine the combined weight of the driver and passengers who will be traveling in your vehicle.
- ▶ **Step 3:** Subtract the combined weight of the driver and passengers from XXX kg or XXX lbs.
- ▶ **Step 4:** The resulting figure equals the permissible payload for cargo and luggage. For example, if the "XXX" amount equals 1,400 lbs and there will be five 150 lb passengers in your vehicle, the available cargo and luggage load capacity is 650 lbs (1,400 – 750 (5 x 150) = 650 lbs).
- ▶ **Step 5:** Determine the combined weight of any cargo and luggage to be loaded into the vehicle. For safety reasons, this weight must not

exceed the permissible payload calculated in step 4.

- ▶ **Step 6:** If your vehicle is towing a trailer, weight is transferred to your vehicle from the trailer. Consult these instructions in order to determine how this reduces the permissible load and luggage capacity of your vehicle.

**i** Note that not all vehicles are approved for trailer operation. Trailer operation is only permissible if a trailer hitch is installed and a trailer load is specified in your vehicle documents. If in doubt, ask an authorized Mercedes-Benz dealer.

Even if you have calculated the total payload carefully, you should still make sure that the maximum permissible gross weight and the maximum axle load of your vehicle are not exceeded. Information on this can be found on the vehicle identification plate.

- ▶ Weigh the laden vehicle – including driver, passengers and payload – on a suitable vehicle weighbridge. The measured values must not exceed the maximum permitted values listed on the vehicle identification plate.

Additional related subjects:

- Sample calculation for determining the maximum payload (→ page 198)
- Tire and Loading Information placard (→ page 197)
- Tire pressure table
- Vehicle identification plate

### Sample calculation for determining the maximum load

The following table has examples of how to calculate total and cargo load capacities with varying seating configurations and different numbers and sizes of occupants. The following examples use a maximum load of 1,500 lbs (680 kg). **This value is for illustrative purposes only.** Make sure you are using the actual load limit for your vehicle stated on your vehicle's Tire and Loading Information placard (→ page 197).

The higher the weight of all the occupants, the smaller the maximum load for luggage.

**Step 1**

	Example 1	Example 2
Combined maximum weight of occupants and load (data from the Tire and Loading Information placard)	1500 lbs (680 kg)	1500 lbs (680 kg)

**Step 2**

	Example 1	Example 2
Number of people in the vehicle (driver and occupants)	5	1
Distribution of the occupants	Front: 2 Rear: 3	Front: 1
Weight of occupants	Occupant 1: 150 lbs (68 kg) Occupant 2: 180 lbs (82 kg) Occupant 3: 160 lbs (73 kg) Occupant 4: 140 lbs (63 kg) Occupant 5: 120 lbs (54 kg)	Occupant 1: 200 lbs (91 kg)
Total weight of all occupants	750 lbs (340 kg)	200 lbs (91 kg)

**Step 3**

	Example 1	Example 2
Permissible load (maximum gross vehicle weight rating from the Tire and Loading Information placard minus the gross weight of all occupants)	1500 lbs (680 kg) - 750 lbs (340 kg) = 750 lbs (340 kg)	1500 lbs (680 kg) - 200 lbs (91 kg) = 1300 lbs (589 kg)

## Tire labeling

### Overview of tire labeling

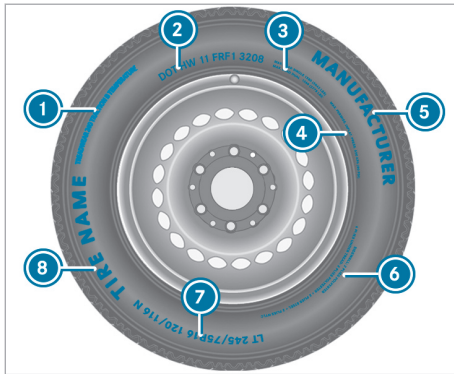

- ① Uniform Tire Quality Grading Standards (→ page 200)
- ② DOT (Department of Transportation), (TIN) Tire Identification Number (→ page 201)
- ③ Maximum tire load (→ page 201)
- ④ Maximum tire pressure (→ page 202)
- ⑤ Manufacturer
- ⑥ Characteristics of the tire (→ page 202)
- ⑦ Tire size designation, load-bearing capacity and speed rating (→ page 202)
- ⑧ Tire name
- ⓘ The data shown in the illustration is sample data.

### Information on tire quality grades

According to the requirements of the U.S. Department of Transportation's "Uniform Tire Quality Grading Standards" tire manufacturers must grade their tires using the following three performance factors:

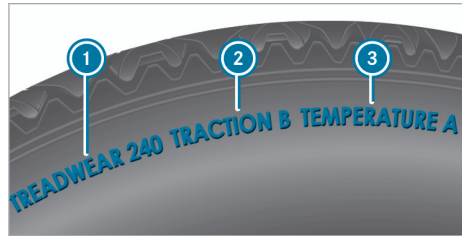

- ① Tread wear grade
- ② Traction grade
- ③ Temperature grade
- ⓘ The data shown in the illustration is sample data.
- ⓘ This grading is not legally prescribed for Canada, but specified in most cases anyway.

### Tread wear grade

The tread wear grade is a comparative grading based on tread wear grade tests conducted under controlled conditions on a specified U.S. Department of Transportation test track. For example, a tire graded 150 would wear one and one-half times as well on the government test track as a tire graded 100.

The relative performance of tires depends upon the actual conditions of their use, however, and may depart significantly from the norm due to variations in driving habits, service practices and differences in road characteristics and climate conditions.

### Traction grade

**⚠ DANGER** Risk of accident due to inadequate traction

The traction grade assigned to this tire is based on straight-ahead braking traction tests.

▶ Always adapt your driving style and drive at a speed to suit the prevailing traffic and weather conditions.

**! NOTE** Damage to the drivetrain from wheelspin

▶ Avoid wheelspin.

The traction grades – from highest to lowest – are AA, A, B and C. These grades relate to the tire's ability to come to a standstill on a wet pavement under controlled conditions on a specified U.S.

government test surface made from asphalt and concrete.

### Temperature grade

**⚠ WARNING** Risk of accident from tire overheating and tire failure

Excessive speed, underinflation, or excessive loading, either separately or in combination, can cause excessive heat build-up and possible tire failure.

- ▶ Observe the recommended tire pressure.
- ▶ Regularly check the pressure of all the tires.
- ▶ Adjust the tire pressure, if necessary.

The temperature grades are A (highest grade), B and C. These relate to a tire's resistance to heat and its ability to release heat on a specified test wheel in laboratory tests under controlled conditions. Sustained high temperatures can cause the material of the tire to degenerate and reduce tire life. In addition, excessively high temperatures can lead to sudden tire failure. Grade C refers to a performance which all passenger vehicle tires must exhibit, according to the U.S. Department of Transportation's requirements.

### Information on DOT and TIN (Tire Identification Number)

U.S. tire regulations indicate that every tire manufacturer or retreader must imprint a TIN in or on the sidewall of each tire produced.

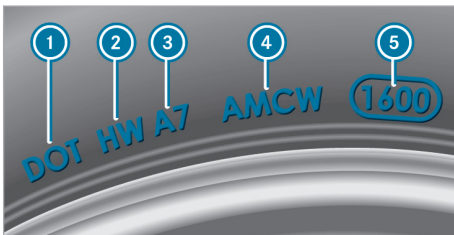

**i** The data shown in the illustration is sample data.

The TIN is a unique identification number for tires and consists of the following components:

- **DOT (Department of Transportation):** tire symbol **1** indicates that the tire complies with the

requirements of the U.S. Department of Transportation.

- **Manufacturer identification code:** manufacturer identification code **2** provides information about the tire manufacturer. New tires have a code with two symbols. Retreaded tires have a code with four symbols. For further information about retreaded tires, see (→ page 205).
- **Tire size:** identifier **3** describes the tire size.
- **Tire type code:** tire type code **4** can be used by the manufacturer as a code to describe specific characteristics of the tire.
- **Date of manufacture:** date of manufacture **5** provides information about the age of a tire. The 1st and 2nd numbers indicate the calendar week and the 3rd and 4th numbers indicate the year of manufacture (e.g. "3208" refers to the 32nd week of the year 2008).

### Information on maximum tire load



**i** The data shown in the illustration is sample data.

Maximum tire load **1** is the maximum permissible weight for which the tire is approved.

Do not overload the tires by exceeding the maximum permissible load. The maximum permissible load can be found on the vehicle's Tire and Loading Information placard on the B-pillar on the driver's side (→ page 197).

### Information on maximum tire pressure

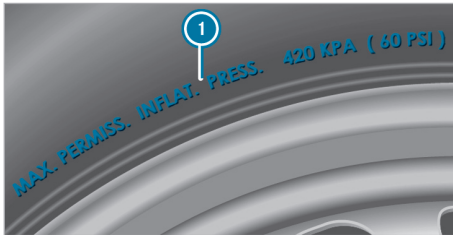

- i** The data shown in the illustration is sample data.

Maximum permitted tire pressure **1** for which the tire is approved must not be exceeded.

### Information on tire characteristics



- i** The data shown in the illustration is sample data.

This information describes the type of tire cord and the number of layers in sidewall **1** and under tire tread **2**.

### Tire size designation, load-bearing capacity and speed rating

**⚠ WARNING** Risk of injury through exceeding the specified tire load-bearing capacity or the permissible speed rating

Exceeding the specified tire load rating or the permissible speed rating may lead to tire damage and to the tires bursting.

- ▶ Therefore, only use tire types and sizes approved for your vehicle model.
- ▶ Observe the tire load rating and speed rating required for your vehicle.

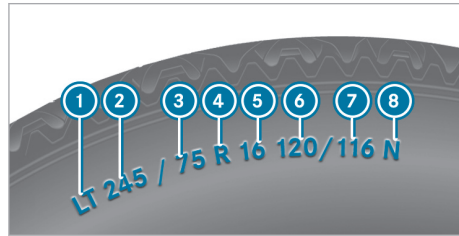

- 1** First letter(s)
- 2** Nominal tire width in millimeters
- 3** Aspect ratio in %
- 4** Tire code
- 5** Rim diameter
- 6** Load-bearing index, Single tires
- 7** Load-bearing index, twin tires
- 8** Speed rating

- i** The data shown in the illustration is sample data.

Further information about reading tire data can be obtained from any qualified specialist workshop.

#### First letter(s) **1**:

- "LT": light truck tires according to US manufacturing standards
- "C": tires for commercial usage in accordance with European manufacturer standards

#### Aspect ratio (in percent) **3**:

The size ratio between the tire height and tire width and is shown in percent (tire height divided by tire width).

#### Tire code **4** (tire type):

- "R": radial tire

#### Rim diameter **5**:

The diameter of the bead seat (not the diameter of the rim flange). The rim diameter is specified in inches (in).

#### Load-bearing index **6** and **7**:

Numerical code which specifies the maximum load-bearing capacity of a tire ("91" equals, e.g. 1,356 lb (615 kg)).

The tire load-bearing capacity must be at least half the permissible axle load of the vehicle. Do not overload the tires by exceeding the maximum permissible load of the tires.

See also:

- Maximum permissible load on the Tire and Loading Information placard (→ page 197)
- Maximum tire load (→ page 201)

### Speed rating

Specifies the approved maximum design speed of the tire.

-  An electronic speed limiter prevents your vehicle from exceeding a speed of 130 mph (210 km/h).

Ensure that your tires have the required speed rating. You can obtain information on the required speed rating at an authorized Mercedes-Benz Center.

### Summer tires

Index	Speed rating
L	Up to 75 mph (120 km/h)
M	Up to 81 mph (130 km/h)
N	Up to 87 mph (140 km/h)
P	Up to 93 mph (150 km/h)
Q	Up to 100 mph (160 km/h)
R	Up to 106 mph (170 km/h)

### Summer, all-season and winter tires

Index	Speed rating
L M+S <sup>1</sup>	Up to 75 mph (120 km/h)
M M+S <sup>1</sup>	Up to 81 mph (130 km/h)
N M+S <sup>1</sup>	Up to 87 mph (140 km/h)
P M+S <sup>1</sup>	Up to 93 mph (150 km/h)

Index	Speed rating
Q M+S <sup>1</sup>	Up to 100 mph (160 km/h)
R M+S <sup>1</sup>	Up to 118 mph (170 km/h)

<sup>1</sup>: Or "M+S  " for winter tires.

Winter tires are marked with the  snowflake symbol and fulfill the requirements of the Rubber Manufacturers Association (RMA) and the Rubber Association of Canada (RAC) regarding the tire traction on snow.

### Information on definitions (tires and loading)

**Tire structure and characteristics:** describes the number of layers or the number of rubber-coated layers in the tire tread and the tire wall. These are made of steel, nylon, polyester and other materials.

**Bar:** metric unit for tire pressure. 14.5038 pounds per square inch (psi) and 100 kilopascals (kPa) are the equivalent of 1 bar.

**DOT (Department of Transportation):** DOT marked tires fulfill the requirements of the U.S. Department of Transportation.

**Average weight of vehicle occupants:** the number of occupants for which the vehicle is designed multiplied by 150 lbs (68 kg).

**Uniform Tire Quality Grading Standards:** a uniform standard to grade the quality of tires with regards to tread quality, tire traction and temperature characteristics. The quality grading assessment is made by the manufacturer in accordance with test specifications of the U.S. government. The quality grade of a tire is imprinted on the sidewall of the tire.

**Recommended tire pressure:** the recommended tire pressure is the pressure specified for the tires installed on the vehicle at the factory.

The Tire and Loading Information placard contains the recommended tire pressures for cold tires, the maximum permissible load and the maximum permissible vehicle speed.

The tire pressure table contains the recommended tire pressures for cold tires under various operating conditions, i.e. load and/or speed of the vehicle.

**Increased vehicle weight due to optional equipment:** the combined weight of all standard and

optional equipment available for the vehicle, regardless of whether it is actually installed on the vehicle or not.

**Rim:** the part of the wheel on which the tire is installed.

**GAWR (Gross Axle Weight Rating):** GAWR is the gross axle weight rating. The actual load on an axle must never exceed the Gross Axle Weight Rating. You can find the Gross Axle Weight Rating on the B-pillar on the driver's side.

**Speed rating:** the speed rating is part of the tire identification. It specifies the speed range for which a tire is approved.

**GVW (Gross Vehicle Weight):** the Gross Vehicle Weight includes the weight of the vehicle including fuel, tools, the spare wheel, accessories installed, occupants, luggage and the trailer drawbar nose-weight if applicable. The Gross Vehicle Weight must never exceed the Gross Vehicle Weight Rating (GVWR) specified on the B-pillar on the driver's side.

**GVWR (Gross Vehicle Weight Rating):** the GVWR is the maximum permitted gross weight of the fully laden vehicle (weight of the vehicle including all accessories, occupants, fuel, luggage and the trailer drawbar noseweight if applicable). The Gross Vehicle Weight Rating is specified on the vehicle identification plate on the B-pillar on the driver's side.

**Maximum weight of the laden vehicle:** the maximum weight is the sum of the vehicle's curb weight, weight of the accessories, maximum load and the weight of the factory-installed optional equipment.

**Kilopascal (kPa):** metric unit for tire pressure. 6.9 kPa are the equivalent of 1 psi. Another unit for tire pressure is bar. 100 kilopascals (kPa) are the equivalent of 1 bar.

**Curb weight:** the weight of a vehicle with standard equipment including the maximum capacity of fuel, oil and coolant. It also includes the air-conditioning system and optional equipment if these are installed on the vehicle, but does not include passengers or luggage.

**Maximum tire load:** the maximum tire load is the maximum permissible weight in kilograms or lbs for which a tire is approved.

**Maximum permissible tire pressure:** maximum permissible tire pressure for one tire.

**Maximum load on one tire:** maximum load on one tire. This is calculated by dividing the maximum axle load for one axle by two.

**PSI (pounds per square inch):** standard unit of measurement for tire pressure.

**Aspect ratio:** relationship between tire height and tire width in percent.

**Tire pressure:** pressure inside the tire applying outward force to every square inch of the tire's surface. The tire pressure is specified in pounds per square inch (psi), in kilopascals (kPa) or in bar. The tire pressure should only be corrected when the tires are cold.

**Tire pressure of cold tires:** the tires are cold when the vehicle has been parked with the tires out of direct sunlight for at least three hours and the vehicle has been driven less than 1 mile (1.6 km).

**Tire contact surface:** the part of the tire that comes into contact with the road.

**Tire bead:** the purpose of the tire bead is to ensure that the tire sits securely on the wheel rim. There are several wire cores in the tire bead to prevent the tire from changing length on the wheel rim.

**Side wall:** the part of the tire between the tread and the tire bead.

**Special equipment weight:** the combined weight of those optional extras that weigh more than the replaced standard parts and more than 5 lbs (2.3 kg). Special equipment, such as high-performance brakes, level control system, a roof luggage rack or a high-performance battery, are not included in the curb weight and the weight of the accessories.

**TIN (Tire Identification Number):** a unique identification number which can be used by a tire manufacturer to identify tires, for example, in a product recall, and thus identify the purchasers. The TIN is made up of the manufacturer identification code, tire size, tire type code and the manufacturing date.

**Load-bearing index:** the load-bearing index (also load index) is a code that contains the maximum load-bearing capacity of a tire.

**Traction:** traction is the result of friction between the tires and the road surface.

**Wear indicator:** narrow bars (tread wear bars) that are distributed over the tire tread. If the tire tread is level with the bars, the wear limit of 1/16 in (1.6 mm) has been reached.

**Distribution of vehicle occupants:** distribution of vehicle occupants over designated seat positions in a vehicle.



**Maximum permissible payload weight:** nominal load and luggage load plus 150 lbs (68 kg) multiplied by the number of seats in the vehicle.

### Changing a wheel

#### Notes on selecting, installing and replacing tires

You can obtain information regarding permissible wheel/tire combinations at a qualified specialist workshop.

**⚠ WARNING** Risk of accident due to incorrect wheel and tire dimensions

If wheels and tires of the wrong size are used, the service brakes or wheel suspension components may be damaged.

- ▶ Always replace wheels and tires with ones that fulfill the specifications of the original part.

For wheels, pay attention to the following:

- Designation
- Type
- Permissible wheel load
- Wheel offset

For tires, pay attention to the following:

- Designation
- Manufacturer
- Type
- Load-bearing index
- Speed rating

**⚠ WARNING** Risk of injury through exceeding the specified tire load-bearing capacity or the permissible speed rating

Exceeding the specified tire load rating or the permissible speed rating may lead to tire damage and to the tires bursting.

- ▶ Therefore, only use tire types and sizes approved for your vehicle model.
- ▶ Observe the tire load rating and speed rating required for your vehicle.

**! NOTE** Vehicle and tire damage due to tire types and sizes that have not been approved

For safety reasons, only use tires, wheels and accessory parts which have been specially approved by Mercedes-Benz for your vehicle.

These tires have been specially adapted for use with driving systems and driving safety systems, such as ABS or ESP®.

Otherwise, certain properties, such as handling characteristics, vehicle noise emissions and consumption could be adversely affected. Other wheel sizes may cause the tires to come into contact with the vehicle body and axle components when under load. This may result in damage to the tire or the vehicle.

- ▶ Only use tires, wheels and accessory parts that have been checked and recommended by Mercedes-Benz.

**! NOTE** Driving safety put at risk by retreaded tires

Retreaded tires are not checked or recommended by Mercedes-Benz, as previous damage is not always detected during the retread process.

Driving safety cannot, therefore, be guaranteed.

- ▶ Do not use used tires when their previous usage is unknown.

Accessories that are not approved for your vehicle by Mercedes-Benz, or are not being used correctly, can impair operating safety.

Before purchasing and using non-approved accessories, visit a qualified specialist workshop and inquire about:

- suitability
- legal provisions
- factory recommendations

Observe the following points when selecting, installing and replacing tires:

- Use only tyres and wheels of the same type, design (winter tyres, all-season tyres) and make.
- Only install wheels of the same size and tread pattern on one axle (left and right).

It is only permissible to deviate from this in the event of a flat tire to drive to the specialist workshop.

- Only install tires of the correct size on the wheels.
- **Vehicles with a tire pressure monitoring system:** all installed wheels must be equipped with functioning sensors for the tire pressure monitoring system.
- At temperatures below 50 °F (10 °C), use winter tires or all-season tires marked M+S on all wheels.

Winter tires bearing the  snowflake symbol in addition to the M+S marking provide the best possible grip in wintry road conditions.

- Only use tires with the same tread pattern.
- Observe the maximum permissible speed for the mounted tires.

If this is below the vehicle's maximum permissible speed, this must be indicated on a label in the driver's field of vision.

- Break in new tires at moderate speeds for the first 60 miles (100 km).
- Replace the tires after six years at the latest, regardless of wear.

For more information on wheels and tires, contact a qualified specialist workshop.

#### **Vehicles with single tires:**

For vehicles with single tires and a GVWR of less than or equal to 9,480 lbs, only use tires of size LT 245/75 R16 that have been approved for this vehicle by the manufacturer. It is not permissible to use tires of different dimensions; doing so may lead to the general operating permit being rendered invalid.

Also observe the following further related subjects:

- Notes on tire pressure (→ page 192)
- Tire and Loading Information placard (→ page 197)
- Tire size designation, load capacity and speed rating (→ page 202)
- Tire pressure table (→ page 193)
- Notes on the emergency spare wheel (→ page 211)

### Notes on changing wheels

#### **WARNING** Risk of injury through different wheel sizes

Rotating the front and rear wheels can severely impair the driving characteristics.

The wheel brakes or suspension components may also be damaged.

- ▶ Rotate front and rear wheels only if the wheels and tires are of the same dimensions.

On vehicles that have the same size front and rear wheels, rotate the wheels according to the intervals in the tire manufacturer's warranty book in your vehicle documents. If this is not available, rotate the tires every 3,000 (5,000) to 6,000 miles (10,000 km), depending on the degree of wear. Ensure that the direction of rotation is maintained.

It is imperative to observe the instructions and safety notes on "Changing a wheel" when doing so.

### Wheel size groups

The determined vehicle speed is displayed in the instrument cluster and is important for controlling the driving safety systems and driving systems. The display accuracy of the speedometer and the odometer is legally prescribed. Determining the speed is dependent on the tire size or the rolling circumference of the tires. The rim diameter is always specified in inches.

For this reason, the vehicle control units can be coded for the following wheel size groups:

Wheel size group 3

- LT245/75 R16

-  Mercedes-Benz recommends that you stay within a wheel size group when changing a tire. In this way, you avoid the need to recode the control units.

If you change the wheel size of your vehicle, for instance when changing wheels for winter operation, check it is assigned to the correct wheel size group. If the wheel size group changes, you must have your vehicle's control units recoded at a qualified specialist workshop.

Otherwise, the display accuracy of the speedometer and the odometer will be outside the legally prescribed tolerance. It may also be lower, i.e. the current road speed is then higher than the speed shown on the speedometer. If a deviation is out-

side the range of tolerance, driving safety systems and driving systems may be operationally impaired or may detect a malfunction and switch themselves off.

### Information on the direction of the tires' rotation

Tires with a specified direction of rotation have additional benefits, e.g. if there is a risk of hydroplaning. You will only gain these benefits if the correct direction of rotation is observed.

An arrow on the sidewall of the tire indicates its correct direction of rotation.

You may also install a spare wheel against the direction of rotation. Observe the time restriction on use as well as the speed limitation specified on the spare wheel.

### Notes on storing wheels

Observe the following when storing wheels:

- Wheels that have been removed should be stored in a cool, dry and, if possible, dark place.
- Protect the tires from oil, grease and fuel.

### Overview of tire-change tool kit

Required tire-changing tools may include, for example:

- Jack
- Wheel wrench

**i** You will find the maximum load capacity of the jack stated on the adhesive label attached to the jack.

The jack is maintenance-free. If there is a malfunction, please contact a qualified specialist workshop.

### Vehicles with rear wheel drive

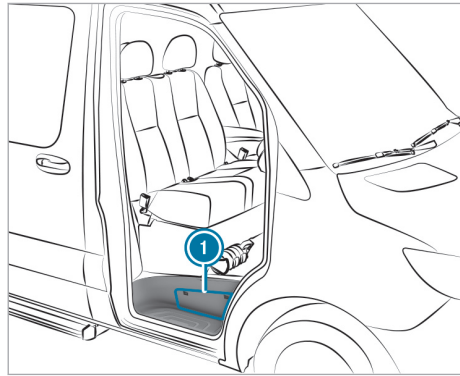

The tire-change tool kit is located in stowage compartment **1** above the step of the front passenger door and in the stowage compartment in the footwell on the front passenger side.

### Preparing the vehicle for a wheel change

#### Requirements

- The tire-change tool kit is available.
- The vehicle is not on a slope.
- The vehicle is on solid, non-slippery and level ground.

- ▶ Apply the parking brake.
- ▶ Move the front wheels to the straight-ahead position.
- ▶ Engage **P**.
- ▶ Switch off the vehicle.
- ▶ Make sure that the vehicle cannot be switched on.
- ▶ Take the vehicle tool kit from the footwell on the co-driver side (→ page 187).

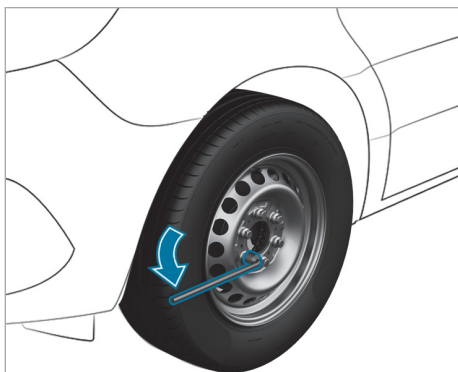

### Vehicles with rear-wheel drive

- ▶ Take the jack and the tire-change tool kit out of the storage compartment (→ page 207).
- ▶ If necessary, remove the wheel trim.
- ▶ Assemble the lug wrench extension using the middle rod and the rod with the largest diameter from the three-piece jack pump lever.
- ▶ Starting with the middle rod, slide the lug wrench extension as far as it will go onto the lug wrench.
- ▶ Using the lug wrench, loosen the wheel nuts or bolts on the wheel you wish to change by about one full turn. Do not unscrew the wheel nuts or bolts completely.
- ▶ Raise the vehicle (→ page 208).

### 3^~Raising the vehicle when changing a wheel

#### **⚠ WARNING** Risk of injury from incorrect positioning of the jack

If you do not position the jack correctly at the appropriate jacking point of the vehicle, the jack could tip with the vehicle raised.

- ▶ Only position the jack at the appropriate jacking point of the vehicle. The base of the jack must be positioned vertically under the jacking point of the vehicle.

#### **⚠ WARNING** Risk of injury from vehicle tipping

On slopes, the jack could tip with the vehicle raised.

- ▶ Never change a wheel on a slope.
- ▶ Consult a qualified specialist workshop.

#### **!** NOTE Damage to the vehicle due to the jack

If you do not position the jack at the jack support points provided for this purpose, you could damage your vehicle.

- ▶ Only position the jack at the jack support points provided for this purpose.

### Requirements

- There is nobody in the vehicle.
- The vehicle is prepared for changing a wheel (→ page 207).

Only position the jack on the jack support points intended for this purpose. Otherwise you could damage the vehicle.

Important notes on using the jack:

- Only use the vehicle-specific jack that has been tested and approved by Mercedes-Benz to raise the vehicle. If the jack is used incorrectly, it could tip over while the vehicle is raised.
- The jack is designed only to raise the vehicle for a short time while a wheel is being changed and is not suitable for carrying out maintenance work under the vehicle.
- Avoid changing a wheel on uphill or downhill slopes.
- The jack must be placed on a firm, flat and non-slip surface. If necessary, use a large, flat, load-bearing and non-slip support.
- The base of the jack must be positioned vertically under the jack support point.

Safety instructions while the vehicle is raised:

- Do not put your hands or feet under the vehicle.
- Do not lie underneath the vehicle.
- Do not start the vehicle and do not release the parking brake.
- Do not open or close any doors.

Vehicles with rear-wheel drive

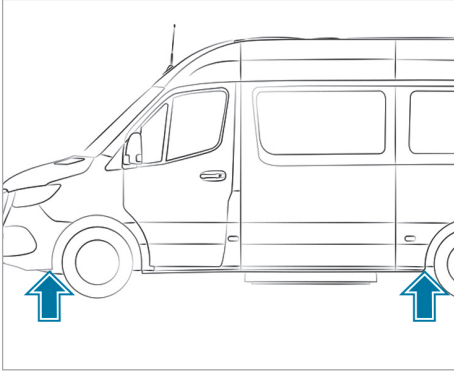

Jack support points

Only use the middle rod and the pump handle rod with the largest diameter for the jack as a wheel wrench extension. Only fit the middle rod on the wheel wrench, and always as far as it will go. Otherwise, the rods could bend and deform so much that they can no longer be used as pump handles for the jack.

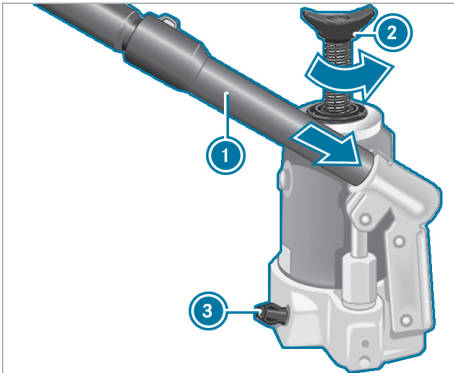

- ▶ **To prepare the hydraulic jack:** Insert the third rod of the jack's pump handle ① into the wheel wrench extension.
  - ▶ Close the pressure release screw ③.
  - ▶ To do this, use the flattened section on the pump handle ① to turn the pressure release screw ③ clockwise to the stop.
- ① Do not turn the pressure release screw ③ more than one or two full turns. Hydraulic fluid could otherwise escape.

- ▶ Insert the pump handle ① with the largest rod pointing forward into the recess on the jack and secure by turning it clockwise.
- ▶ Place the jack vertically beneath the jack support points described below.

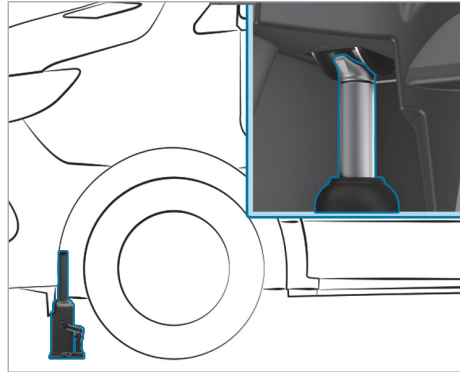

Jack support point, front axle

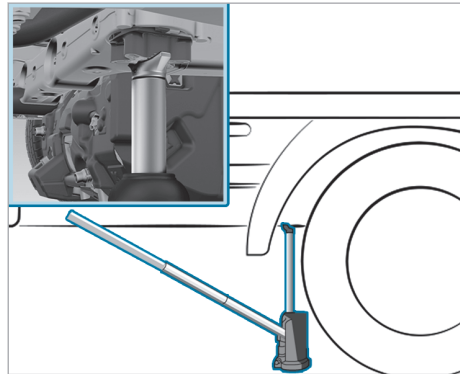

Jack support point, rear axle

- ▶ Place the jack beneath the jack support point.
- ▶ Raise the vehicle until the tire is a maximum of 1.2 in (3 cm) off the ground.
- ▶ Loosen and remove the wheel (→ page 209).

Removing a wheel

Requirements:

- The vehicle is raised (→ page 208).

When changing a wheel, avoid applying any force to the brake discs since this could impair the level of comfort when braking.

**I NOTE** Damage to threading from dirt on wheel bolts

- ▶ Do not place wheel bolts in sand or on a dirty surface.

- ▶ Unscrew the wheel bolts or nuts with the wheel nut wrench.
- ▶ On front wheels with wheel nuts, remove the wheel nut cover.
- ▶ Remove the wheel.

### installing a new wheel

#### Requirements

- The wheel is approved (→ page 209).

**⚠ WARNING** Risk of accident from losing a wheel

Oiled, greased or damaged wheel bolt/wheel nut threads or wheel hub/wheel mounting bolt threads can cause the wheel bolts/wheel nuts to come loose.

- ▶ Never oil or grease the threads.
- ▶ In the event of damage to the threads, contact a qualified specialist workshop immediately.
- ▶ Have the damaged wheel bolts or damaged hub threads replaced.
- ▶ Do not continue driving.

**⚠ WARNING** Risk of injury from tightening wheel bolts and nuts

If you tighten the wheel bolts or wheel nuts when the vehicle is raised, the jack could tip.

- ▶ Only tighten wheel bolts or wheel nuts when the vehicle is on the ground.

- ▶ Observe the information on the choice of tires (→ page 205).
- ▶ Observe the instructions and safety notes on changing a wheel (→ page 205).
- ▶ For safety reasons, only use wheel bolts or wheel nuts which have been approved by Mercedes-Benz and for the wheel in question.

When you install the steel spare wheel, it is essential to use the short wheel bolts for a steel wheel. Using other wheel bolts when installing the steel spare wheel may damage the brake system.

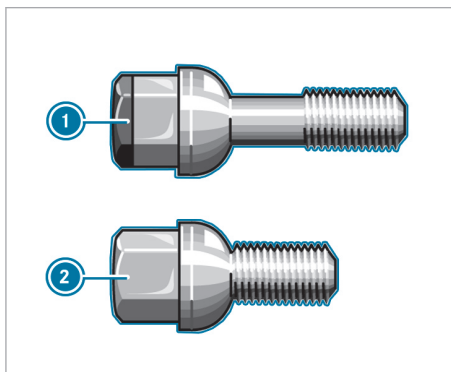

- ① Wheel bolt for light-alloy wheel
- ② Wheel bolt for steel wheel

- ▶ Clean the wheel and wheel hub contact surfaces.
- ▶ Slide the wheel which is to be installed onto the wheel hub and push it on.

#### Vehicles with steel wheels

- ▶ Use the short wheel bolts intended for the steel spare wheel, which are found in the vehicle tool kit.
- ▶ Screw in the wheel bolts until they are hand-tight.

#### Vehicles with light alloy wheels

- ▶ Use the long wheel bolts intended for the light-alloy spare wheel, which are found in the vehicle tool kit.
- ▶ Screw in the wheel bolts until they are hand-tight.

### Lowering the vehicle after a wheel change

**⚠ WARNING** Risk of accident due to incorrect tightening torque

The wheels could come loose if the wheel bolts or wheel nuts are not tightened to the prescribed torque.

- ▶ Ensure that the wheel bolts or wheel nuts are tightened to the prescribed tightening torque.
- ▶ If you are not sure, do not move the vehicle. Contact a qualified specialist workshop and have the tightening torque checked immediately.

**Requirements:**

- The new wheel has been installed (→ page 210).

Observe the notes on raising the vehicle (→ page 208).

**Vehicles with rear-wheel drive**

Only use the middle rod and the pump lever rod with the largest diameter for the jack as a lug wrench extension. Only insert the middle rod on the lug wrench, and always as far as it will go. Otherwise, the rods could bend and deform so much that they can no longer be used as pump levers for the jack.

- ▶ Using the pump lever, slowly turn the drain screw on the jack approximately one revolution and carefully lower the vehicle.
- ▶ Place the jack to one side.
- ▶ Pull the rod with the smallest diameter off the pump lever. The shortened pump lever serves as a lug wrench extension.
- ▶ Starting with the middle rod, slide the lug wrench extension as far as it will go onto the lug wrench.

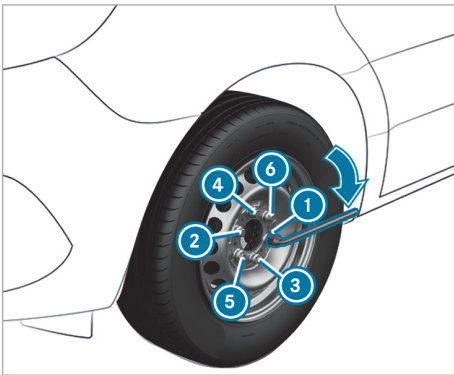

- ▶ Tighten the wheel bolts or nuts evenly in the sequence indicated (❶ to ❷).  
Specified tightening torque:
  - Steel wheel bolts: 177 lb-ft (240 Nm)
  - Light alloy wheel bolts: 133 lb-ft (180 Nm)
- ▶ Push the piston on the hydraulic jack in again and close the pressure release screw.
- ❶ You can now install the hub caps on steel wheels with wheel bolts. The installing procedure depends on whether the hub cap acts as

a trim that covers the whole wheel, or just covers the center.

- ▶ **Wheel with wheel trim:** position the opening in the wheel trim for the tire valve over the tire valve.
- ▶ Push the edge of the hub cap onto the wheel rim with both hands until it engages into place. Make sure the hub cap retaining catches engage on the steel wheel.
- ▶ **Wheel with central hub cap:** position the retaining lugs of the central hub cap over the wheel bolts.
- ▶ Hit the middle of the hub cap to engage it on the wheel.
- ▶ Secure the faulty wheel in the spare wheel holder.
- ▶ Check the tire pressure of the newly installed wheel and adjust it if necessary.
- ▶ Retighten the wheel bolts or wheel nuts to the specified tightening torque after the vehicle has been driven 31 miles (50 km).
- ▶ When using a wheel or spare wheel with a new or newly painted wheel rim, have the wheel bolts or wheel nuts retightened after approximately 620 miles (1,000 km) to 3,100 miles (5,000 km).

- ❶ **Vehicles with a tire pressure monitoring system:** all wheels installed must be equipped with functioning sensors.

Make sure to observe the following further related subject:

- Notes on tire pressure (→ page 192)

**Spare wheel****Notes on the emergency spare wheel and spare wheel**

**Emergency spare wheel:** wheel and/or tire dimensions as well as the type of tire are different from the wheel to be replaced.

- ❶ A label with the speed limitation can be found on the emergency spare wheel.

**Spare wheel:** wheel and tire dimensions as well as the type of tire correspond to the other installed wheels.

A installed emergency spare wheel or spare wheel changes the driving characteristics and bears risks.

**▲ WARNING** Risk of accident due to incorrect wheel and tire dimensions

Mounting an emergency spare wheel or spare wheel may severely impair the driving characteristics.

There is an increased risk of an accident.

To prevent hazardous situations:

- ▶ Check the tire pressure of the spare wheel or emergency spare wheel once installed and, if necessary, adjust.
- ▶ The emergency spare wheel may only be used temporarily and must be replaced with a standard wheel as soon as possible.
- ▶ Never install more than one emergency spare wheel.
- ▶ Adapt your driving style and drive carefully in emergency spare wheel mode.
- ▶ Do not switch off ESP®.
- ▶ Do not use snow chains on the emergency spare wheel.
- ▶ Replace the emergency spare wheel after six years at the latest, regardless of wear.

- When using an emergency spare wheel or spare wheel (different from the wheel to be replaced), you must not exceed a permissible top speed of 50 mph (80 km/h).
- Have the emergency spare wheel or spare wheel replaced by a qualified specialist workshop (→ page 205).
- The tire pressure of the emergency spare wheel or spare wheel must be checked before starting a journey and, if necessary, adjusted (→ page 193).

The following should be checked regularly, particularly prior to long journeys:

- that the emergency spare wheel or spare wheel is firmly secured
- the tire pressure of the emergency spare wheel or spare wheel (adjust the tire pressure if necessary) (→ page 193)
- the fastenings of the emergency spare wheel holder or spare wheel holder

The spare wheel is located either in the load compartment or in a spare wheel holder under the vehicle.

Replace the tires after six years at the latest, regardless of wear. This also applies to the spare wheel.

- ⓘ If you have installed an emergency spare wheel or a spare wheel, the tire pressure monitoring system will not function for this wheel. The emergency spare wheel or spare wheel is not equipped with a sensor for the tire pressure monitoring system.

### installing and removing the spare wheel

#### Vehicles with rear-wheel drive: removing the spare wheel (panel van or crewbus)

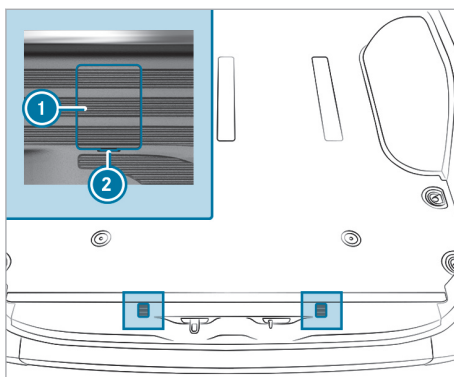

Bolt covers for the retaining hooks (example: panel van)

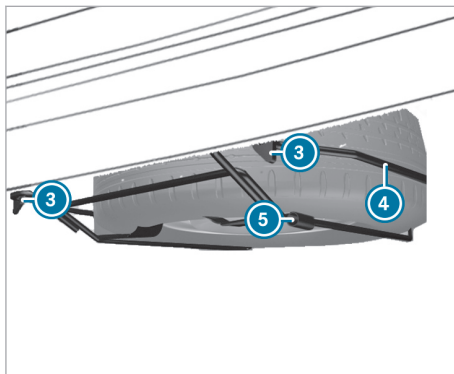

- ▶ Open the rear doors.
- ▶ Insert a screwdriver into the recesses ② and pry off the covers ①.



- ▶ Using the lug wrench from the vehicle tool kit, turn the now visible bolts counter-clockwise by approximately 20 turns.
- ▶ Slightly raise the spare wheel carrier ④ and unhook left-hand retaining hook ③.
- ▶ Assemble the pump lever for the jack and slide it into the sleeve ⑤ on the right-hand side of the spare wheel carrier ④.
- ▶ Raise the spare wheel carrier ④ with the pump lever and unhook the right-hand retaining hook ③.
- ▶ Slowly lower the spare wheel carrier ④ to the ground.
- ▶ Lift the spare wheel carrier ④ slightly and pull the pump lever out of the sleeve.
- ▶ Use the pump lever to lift the spare wheel beyond the rear edge of the spare wheel carrier ④.
- ▶ Carefully remove the spare wheel from the spare wheel carrier ④. The spare wheel is heavy. When the spare wheel is removed, the center of gravity changes owing to the heavy weight of the wheel. The spare wheel may slip down or tip over.

#### Vehicles with rear-wheel drive: installing the spare wheel (panel van or crewbus)

- ▶ Carefully place the spare wheel onto the spare wheel carrier ④. The spare wheel is heavy. When you place the spare wheel onto the spare wheel carrier ④, the center of gravity changes owing to the weight of the wheel. The spare wheel may slip down or tip over.
- ▶ Slide the pump lever for the jack into the sleeve ⑤ on the spare wheel carrier ④.
- ▶ Raise the spare wheel carrier ④ with the pump lever and attach the right-hand retaining hook ③.
- ▶ Slightly raise the spare wheel carrier ④ and attach the left-hand retaining hook ③.
- ▶ Pull the pump lever out of the sleeve ⑤.
- ▶ Using the lug wrench, tighten the bolts for the retaining hooks ③ by turning them clockwise.
- ▶ Attach and snap in the covers ①.
- ▶ Close the rear doors.

#### Vehicles with rear-wheel drive: removing the spare wheel (vehicle with lowered chassis)

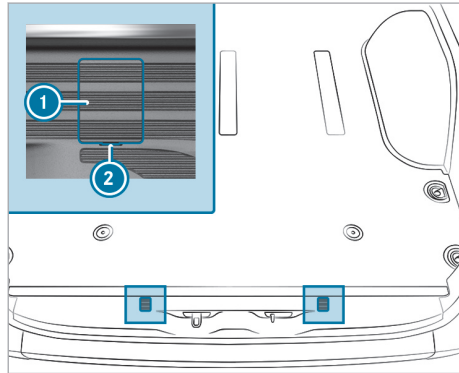

Bolt covers for the retaining hooks (example: panel van)

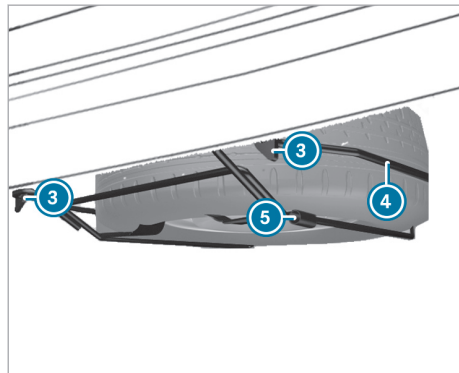

- ▶ Open the rear doors.
- ▶ Insert a screwdriver into the recesses ② and pry off the covers ①.
- ▶ Using the lug wrench from the vehicle tool kit, turn the now visible bolts counter-clockwise by approximately 20 turns.
- ▶ Slightly raise the spare wheel carrier ④ and unhook the left-hand retaining hook ③.
- ▶ Assemble the pump lever for the jack and slide it into the sleeve ⑤ on the right-hand side of the spare wheel carrier ④.
- ▶ Raise the spare wheel carrier with the pump lever and unhook the right-hand retaining hook ③.
- ▶ Prepare the jack.

- ▶ Place the jack beneath the corresponding jack support point.
- ▶ Move the pump lever up and down until the tire is raised a maximum of 1.18 in (3 cm) off the ground.
- ▶ Carefully remove the spare wheel from the spare wheel carrier ④. The spare wheel is heavy. When the spare wheel is removed, the center of gravity changes owing to the heavy weight of the wheel. The spare wheel may slip down or tip over.
- ▶ install the spare wheel on the vehicle.
- ▶ Lower the vehicle.

#### Vehicles with rear-wheel drive: installing the spare wheel (vehicle with lowered chassis)

- ① In the event of a flat tire, you may only place the defective wheel inside the vehicle. An intact wheel may be stored in the spare wheel carrier only when the vehicle is unladen. A laden vehicle must first be raised.
- ▶ Carefully place the spare wheel onto the spare wheel carrier ④. The spare wheel is heavy. When you place the spare wheel onto the spare wheel carrier ④, the center of gravity changes owing to the weight of the wheel. The spare wheel may slip down or tip over.
- ▶ Slide the pump lever for the jack into the sleeve ⑤ on the spare wheel carrier ④.
- ▶ Raise the spare wheel carrier ④ with the pump lever and attach the right-hand retaining hook ③.
- ▶ Slightly raise the spare wheel carrier ④ and attach the left-hand retaining hook ①.
- ▶ Pull the pump lever out of the sleeve ⑤.
- ▶ Using the lug wrench, tighten the bolts for the retaining hooks ③ by turning them clockwise.
- ▶ Attach and snap in the covers ①.
- ▶ Close the rear doors.

#### Vehicles with rear-wheel drive: removing the spare wheel (chassis)

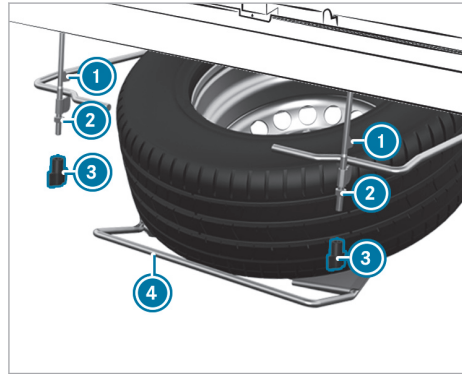

- ▶ Loosen the wing nuts ③ manually and remove them.
- ▶ Loosen the nuts ② to the thread end.
- ▶ Slightly raise the spare wheel carrier ④ and unhook the left-hand retaining hook ①.
- ▶ Assemble the pump lever for the jack and slide it into the sleeve on the right-hand side of the spare wheel carrier ④.
- ▶ Raise the spare wheel carrier ④ with the pump lever and unhook the right-hand retaining hook ③.
- ▶ Slowly lower the spare wheel carrier ④ to the ground.
- ▶ Lift the spare wheel carrier ④ slightly and pull the pump lever out of the sleeve.
- ▶ Use the pump lever to lift the spare wheel beyond the rear edge of the spare wheel carrier.
- ▶ Carefully remove the spare wheel from the spare wheel carrier. The spare wheel is heavy. When the spare wheel is removed, the center of gravity changes owing to the heavy weight of the wheel. The spare wheel may slip down or tip over.

#### Vehicles with rear-wheel drive: installing the spare wheel (chassis)

- ▶ Carefully place the spare wheel onto the spare wheel carrier ④. The spare wheel is heavy. When you place the spare wheel onto the spare wheel carrier, the center of gravity changes owing to the weight of the wheel. The spare wheel may slip down or tip over.

- ▶ Slide the pump lever for the jack into the sleeve on the spare wheel carrier ④.
- ▶ Raise the spare wheel carrier ④ with the pump lever and attach the right-hand retaining hook ①.
- ▶ Slightly raise the spare wheel carrier and attach the left-hand retaining hook ①.
- ▶ Pull the pump lever out of the sleeve.
- ▶ Tighten the nuts ②.
- ▶ Start the wing nuts ③ and tighten them.

**Information on the technical data**

The given data only applies to vehicles with standard equipment. You can obtain further information at a qualified specialist workshop.

**On-board electronics**

**Notes on work on the engine electronics**

**! NOTES** Premature wear through improper maintenance

Improper maintenance may cause vehicle components to wear more quickly and the vehicle's operating permit may be invalidated.

- ▶ Always have work on the engine electronics and related components carried out at a qualified specialist workshop.

**Two-way radios**

**Installation notes for two-way radios**

**⚠ WARNING** Risk of accident due to improper work on two-way radios

If two-way radios are manipulated or retrofitted incorrectly, the electromagnetic radiation from the two-way radios can interfere with the vehicle electronics and jeopardize the operating safety of the vehicle.

- ▶ You should have all work on electrical and electronic components carried out at a qualified specialist workshop.

**⚠ WARNING** Risk of accident due to improper operation of two-way radios

If you use two-way radios in the vehicle improperly, their electromagnetic radiation can disrupt the vehicle's electronics. This is the case in the following situations, in particular:

- The two-way radio is not connected to an exterior antenna.
- The exterior antenna is installed incorrectly or is not a low-reflection antenna.

This could jeopardize the operating safety of the vehicle.

- ▶ Have the low-reflection exterior antenna installed at a qualified specialist workshop.

- ▶ When operating two-way radios in the vehicle, always connect them to the low-reflection exterior antenna.

**! NOTE** Invalidation of the operating permit due to failure to comply with the instructions for installation and use

The operating permit may be invalidated if the instructions for installation and use of two-way radios are not observed.

- ▶ Only use approved frequency bands.
- ▶ Observe the maximum permissible output power in these frequency bands.
- ▶ Only use approved antenna positions.

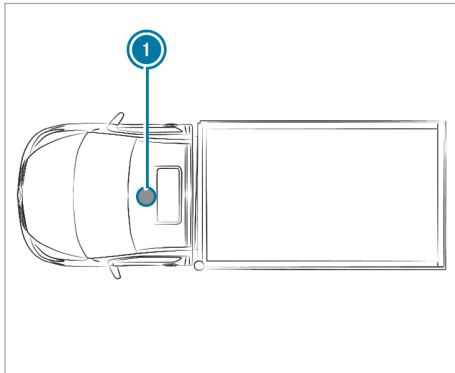

Cab Chassis (standard cab)

① Front roof area

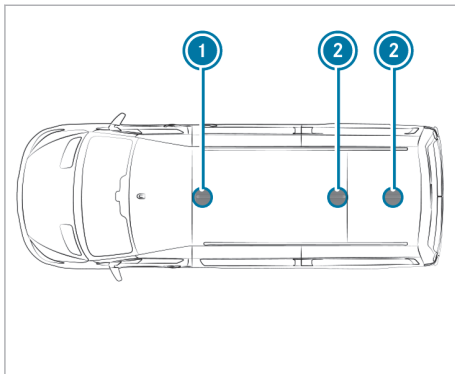

Cargo Van

① Front roof area

② Rear roof area

Use Technical Specification ISO/TS 21 609 (Road Vehicles - EMC guidelines for installation of after-market radio frequency transmitting equipment) when retrofitting two-way radios. Comply with the legal requirements for detachable parts.

If your vehicle has pre-installation for two-way radio equipment, use the power supply or antenna connections intended for use with the pre-installation. Observe the manufacturer's supplements during installation.

**Transmission output of two-way radios**

The maximum transmission outputs (PEAK) at the base of the antenna must not exceed the values in the following table:

**Frequency band and maximum transmission output**

Frequency band	Maximum transmission output
2 -m- frequency band 144 - 174 MHz	50 W
4-m-frequency band 74 - 88 MHz	30 W
Terrestrial Trunked Radio (TETRA) 380 - 460 MHz	10 W
Mobile telephony 2G	2 W
Mobile telephony 3G/4G/5G	0.5 W

There are no restrictions on use of the following devices in the vehicle:

- Two-way radios with a maximum transmission output of up to 100 mW
- Two-way radios with transmitter frequencies in the 380-410 MHz frequency band and a maximum transmission output of up to 2 W (trunked radio system/Tetra)
- Mobile phones (2G/3G/4G/5G)

There are no restrictions on positioning the antenna on the outside of the vehicle for the following frequency bands:

- Terrestrial Trunked Radio (TETRA)
- 2G/3G/4G/5G

**Radio regulations**

**Regulatory radio identifiers and specific notes**

Manufacturer information about radio-based vehicle components can be found using the key phrase "Regulatory radio information" in the Digital Operator's Manual in the vehicle, on the internet and in the app.

Further information and updates are available at the following web address:

<https://regulatoryradioinformation.corpinter.net/vans/us>



**Information about the specific absorption rate (SAR)**

Information about the specific absorption rate (SAR) can be found using the key phrase "Regulatory radio information" in the Digital Operator's Manual in the vehicle, on the internet and in the app.

Further information and updates are available at the following web address:

<https://regulatoryradioinformation.corpinter.net/vans/us>



**Vehicle identification plate, vehicle identification number (VIN) and engine number**

**Vehicle identification plate**

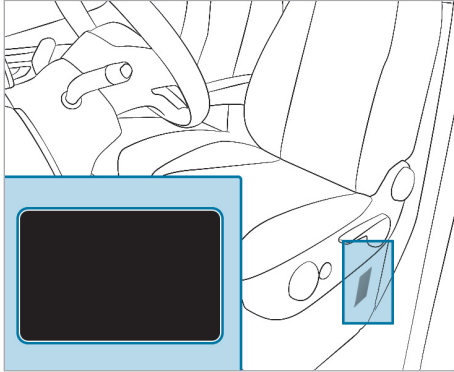

Depending on the vehicle model, the vehicle identification plate is located on the seat box of the driver's seat or on the B-pillar.

- i** The data is vehicle-specific and may differ from that shown. Always observe the specifications on your vehicle identification plate.

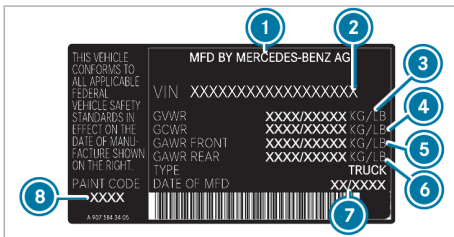

Vehicle identification plate (example: USA, complete vehicles)

- 1 Vehicle manufacturer
- 2 VIN (vehicle identification number)
- 3 Permissible gross mass
- 4 Permissible gross mass of vehicle combination
- 5 Maximum permissible front axle load
- 6 Maximum permissible rear axle load
- 7 Manufacturing date
- 8 Paint code

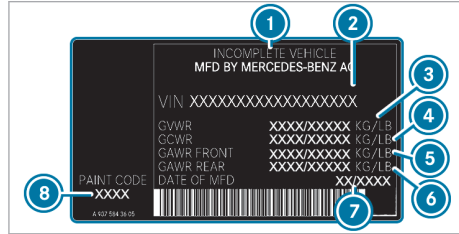

Vehicle identification plate (example: USA, incomplete vehicles)

- 1 Vehicle manufacturer
- 2 VIN (vehicle identification number)
- 3 Permissible gross mass
- 4 Permissible gross mass of vehicle combination
- 5 Maximum permissible front axle load
- 6 Maximum permissible rear axle load
- 7 Manufacturing date
- 8 Paint code

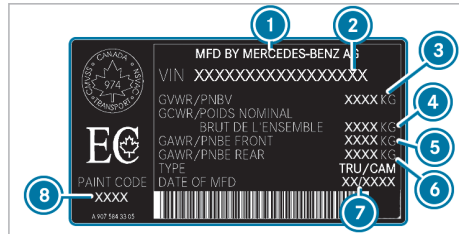

Vehicle identification plate (example: Canada, complete vehicles)

- 1 Vehicle manufacturer
- 2 VIN (vehicle identification number)
- 3 Permissible gross mass
- 4 Permissible gross mass of vehicle combination
- 5 Maximum permissible front axle load
- 6 Maximum permissible rear axle load
- 7 Manufacturing date
- 8 Paint code

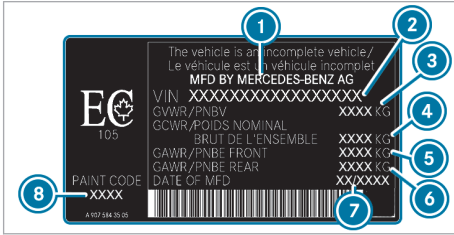

Vehicle identification plate (example: Canada, incomplete vehicles)

- ① Vehicle manufacturer
- ② VIN (vehicle identification number)
- ③ Permissible gross mass
- ④ Permissible gross mass of vehicle combination
- ⑤ Maximum permissible front axle load
- ⑥ Maximum permissible rear axle load
- ⑦ Manufacturing date
- ⑧ Paint code

The permissible gross mass comprises the vehicle weight, all vehicle occupants, the fuel and the load. The maximum gross axle weight rating is the maximum weight that can be carried by one axle (front or rear axle).

Do not exceed the permissible gross mass or the maximum gross axle weight rating of the front or rear axle.

The vehicle identification plate may also include the following data:

- Payload
- Curb weight
- Number of passenger seats

**VIN engraved underneath the hood**

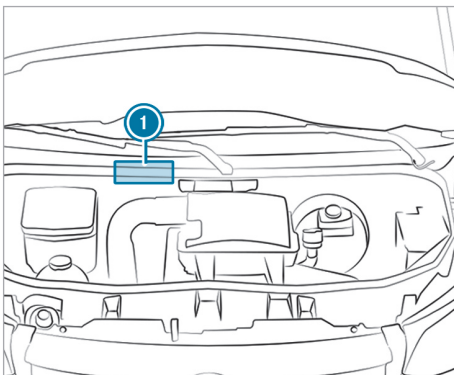

Engraved VIN ① is located underneath the hood.

**VIN below the windshield**

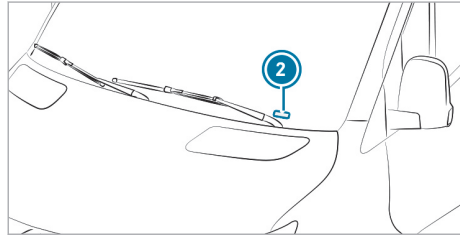

The VIN is also attached as a label on the lower section of the windshield ②.

**Emission Control Information label**

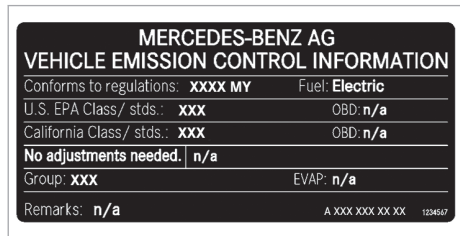

Example: Emission Control Information label

- ① The data is vehicle-specific and may differ from that shown.

**Electric motor number**

The engine number is attached to the bottom of the electric motor at the front. Further information can be obtained at a qualified specialist workshop.

**Operating fluids and capacities**

**Notes on operating fluids**

**⚠ WARNING** Risk of injury due to harmful operating fluids

Operating fluids can be toxic.

- ▶ When using, storing and disposing of operating fluids, observe the imprints on the respective original containers.
- ▶ Always keep operating fluids in the sealed original container.
- ▶ Always keep children away from operating fluids.



**ENVIRONMENTAL NOTE** Pollution of the environment due to irresponsible disposal of operating fluids

Incorrect disposal of operating fluids can cause considerable damage to the environment.

- ▶ Dispose of operating fluids in an environmentally responsible manner.

Operating fluids include the following:

- Lubricants
- Coolant
- Brake fluid
- Windshield washer fluid
- Climate control system refrigerant

Only use products which have been approved for your vehicle by Mercedes-Benz. Damage caused to the vehicle by using products that have not been approved is not covered by the Mercedes-Benz warranty or goodwill gestures.

You can identify operating fluids approved by Mercedes-Benz by the following labels on the container:

- MB-Freigabe (e.g. MB-Freigabe 325.5)
- MB-Approval (e.g. MB-Approval 325.5)

Further information on approved operating fluids is available from the following sources:

- In the MB Specifications for operating fluids at <https://operatingfluids.mercedes-benz.com> (with details of specification).
- At a qualified specialist workshop

Additives for approved operating fluids are neither required nor permitted. Additives can cause engine damage and must therefore not be added to the operating fluids.

### Notes on brake fluid

Observe the notes on operating fluids (→ page 219).



**WARNING** Risk of an accident due to vapor pockets forming in the brake system

The brake fluid constantly absorbs moisture from the air. This lowers the boiling point of the brake fluid. If the boiling point is too low, vapor pockets may form in the brake system when the brakes are applied hard.

This causes the braking effect to be impaired.

- ▶ Have the brake fluid renewed at the specified intervals.

Have the brake fluid replaced every two years at a qualified specialist workshop.



**NOTE** Damage to paint, plastic or rubber by brake fluid

There is a risk of damage to property if brake fluid comes into contact with paint, plastic or rubber.

- ▶ If paint, plastic or rubber comes into contact with brake fluid, rinse with water immediately.

Observe the notes on paintwork/matte paintwork care (→ page 175).

Only use brake fluid approved by Mercedes-Benz in accordance with MB-Freigabe or MB-Approval 331.0.

Information on brake fluid is available at the following locations:

- In the MB Specifications for operating fluids 331.0 at <https://operatingfluids.mercedes-benz.com>
- At a qualified specialist workshop

### Coolant

#### Notes on coolant

Observe the notes on operating fluids (→ page 219).



**WARNING** Risk of fire- and injury from antifreeze

If antifreeze comes into contact with hot component parts in the engine compartment, it may ignite.

- ▶ Allow the drive system to cool down before you add antifreeze.
- ▶ Make sure that no antifreeze spills out next to the filler opening.
- ▶ Thoroughly clean the antifreeze from component parts before starting the vehicle.



**!** **NOTE** Damage caused by incorrect coolant

- ▶ Only add coolant that has been premixed with the required antifreeze protection.

Information on coolant is available at the following locations:

- In the MB Specifications for operating fluids 320.1 at <https://operatingfluids.mercedes-benz.com>
- At a qualified specialist workshop

**!** **NOTE** Overheating at high outside temperatures

If an inappropriate coolant is used, the engine cooling system is not sufficiently protected against overheating and corrosion at high outside temperatures.

- ▶ Always use coolant approved for Mercedes-Benz.
- ▶ Observe the instructions in the MB Specifications for operating fluids 320.1.

**!** **NOTE** Paintwork damage due to coolant

- ▶ Do not spill coolant on painted surfaces.

Have the coolant regularly replaced at a qualified specialist workshop.

Note the proportion of anti-corrosion agent/anti-freeze in the engine cooling system within the following temperature ranges:

- A minimum of 50 % (antifreeze protection down to about -35°F (-37°C))
- A maximum of 55 % (antifreeze protection down to -49°F (-45°C))

### ■ Coolant filling capacity

Missing values were not available at the time of going to press.

#### Coolant

Model	Capacity
Vehicles with 56 kWh high-voltage battery	About 5.6 gal (21.1 liters)
Vehicles with 81 kWh high-voltage battery	About 5.2 gal (19.6 liters)
Vehicles with 113 kWh high-voltage battery	About 4.9 gal (18.5 liters)

## Windshield washer fluid

### ■ Notes on windshield washer fluid

Observe the notes on operating fluids (→ page 219).

**⚠** **WARNING** Risk of fire and injury from windshield washer concentrate

Windshield washer concentrate is highly flammable. If it comes into contact with hot components, it may ignite.

- ▶ Make sure that windshield washer concentrate is not spilled near to the filler opening.

**!** **NOTE** Damage to the exterior lighting due to unsuitable windshield washer fluid

Unsuitable windshield washer fluid may damage the plastic surface of the exterior lighting.

- ▶ Only use windshield washer fluid which is also suitable for use on plastic surfaces, e.g. MB SummerFit or MB WinterFit.

**!** **NOTE** Blocked spray nozzles caused by mixing windshield washer fluids

- ▶ Do not mix MB SummerFit and MB WinterFit with other windshield washer fluids.

Do not use distilled or de-ionized water. Otherwise, the fill level sensor may give a false reading.

### ■ Information on the windshield cleaning agent

Recommended windshield cleaning agent:

- above freezing point: e.g. MB SummerFit
- below freezing point: e.g. MB WinterFit

#### Mixing ratio

For the correct mixing ratio, refer to the information on the anti-freeze container.

Mix the washer fluid with windshield cleaning agent all year round.

#### Filling capacities

##### Windshield washer system

Washer fluid	5.8 qt (5.5 l)
--------------	----------------

## Refrigerant

### Notes on refrigerant

Observe the notes on operating fluids (→ page 219).

- ① Your vehicle's climate control system is filled with the refrigerant R134a. The refrigerant R134a contains fluorinated greenhouse gas.

**!** **NOTE** Damage due to incorrect refrigerant or refrigerant compressor oil

If the incorrect refrigerant or refrigerant compressor oil (PAG oil) is used, this can damage the climate control system.

- ▶ Use only R-134a refrigerant and the PAG oil approved for your vehicle by Mercedes-Benz.
- ▶ Do not mix the approved PAG oil with another PAG oil.

Maintenance work, such as refilling refrigerant or replacing components, may be carried out only by a qualified specialist workshop. All applicable regulations, as well as SAE standard J639, must be adhered to.

Have all work on the climate control system carried out at a qualified specialist workshop.

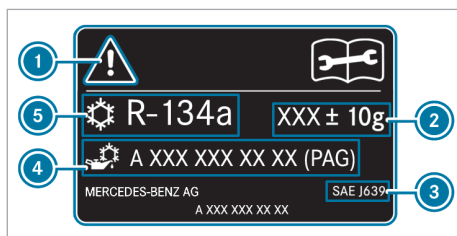

Example: refrigerant information label

- ① Symbols for hazard and service information
- ② Refrigerant capacity
- ③ Applicable standards
- ④ PAG oil part number
- ⑤ Refrigerant type

Symbols ① advise you of the following:

- Potential dangers
- Having maintenance work carried out at a qualified specialist workshop

## Vehicle data

### Vehicle dimensions

The following section contains important technical data for your vehicle. Your vehicle documents contain further vehicle-specific and equipment-dependent technical data such as vehicle dimensions and weights.

### High-voltage battery

#### Energy content and charging times

High-voltage battery 81 kWh	
Type	Lithium-ion
Usable energy content	81 kWh
Charging time – Mode 3 at up to 9.6 kW charging power	approx. 9 h 30 min
Charging time – Mode 4 at up to 50 kW charging power	approx. 1 h 7 min
Charging time – Mode 4 (optional) at up to 115 kW charging power	approx. 32 min

#### Energy content and charging times

High-voltage battery 113 kWh	
Type	Lithium-ion
Usable energy content	113 kWh
Charging time – Mode 3 at up to 9.6 kW charging power	approx. 12 h 30 min

High-voltage battery 113 kWh	
Charging time – Mode 4 at up to 50 kW charging power	approx. 1 h 33 min
Charging time – Mode 4 (optional) at up to 115 kW charging power	approx. 42 min

Charging time – Mode 3 applies to AC charging from 0% to 100% of the usable battery capacity.

Charging time – Mode 4 applies to DC charging from 10% to 80% of the usable battery capacity.

The charging time depends on battery condition, ambient temperature and charging power. The charging power depends on supply voltage, current and the type of power supply.

The charging time may be extended by the battery calibration function. Observe the notes on calibrating the high-voltage battery (→ page 168)

### Trailer hitch

#### Notes on the trailer hitch

**⚠ WARNING** Risk of accident due to impermissible attachment of a trailer tow hitch

If you install a trailer tow hitch or other components, the longitudinal frame member is weakened and can break. The trailer may become detached from the vehicle.

There is a risk of an accident.

Only retrofit a trailer tow hitch if permissible.

Observe the notes on trailer operation (→ page 131).

Retrofitting a trailer hitch is only permissible if a towing capacity is specified in your vehicle documents.

You can obtain further information on the trailer hitch at a qualified specialist workshop.

Mercedes-Benz recommends that you have a trailer hitch retrofitted at an authorized Mercedes-Benz Center.

Only use a trailer hitch which has been tested and specially approved by Mercedes-Benz for your vehicle.

Use only a ball neck that has been approved for your vehicle and for your Sprinter trailer hitch. Notes on the permissible dimensions of the ball neck can also be found on the identification plate of the trailer hitch.

The maximum permissible towing capacity for unbraked trailers is 1,653 lbs (750 kg).

#### Trailer loads

The permissible weights and loads can also be obtained from the following sources of information:

- Vehicle documents
- The identification plates of the trailer coupling, trailer and vehicle

The values approved by the manufacturer can be found in the following table. If the figures differ, the lowest figure will apply. Use a calibrated weighing device to check compliance with weight restrictions before you start your journey.

**Maximum permissible weights and loads****Vehicle type, gross vehicle weight and curb weight**

Vehicle model	Gross vehicle weight rating (GVWR)	Permissible curb weight <sup>7)</sup>
3500	9900 lbs (4.490 t) (Canada only)	7400 lbs (3.357 t)
	9989 lbs (4.531 t) (USA only)	

<sup>7)</sup> Maximum permissible curb weight of a vehicle in ready-to-drive condition without driver or vehicle occupants, including all fluids and their reservoirs when filled up to 100%.

**Front axle load, rear axle load, gross weight of vehicle combination (standard, optional)**

**Vehicle type 3500 with a maximum gross vehicle weight rating of 9900 lbs (4.490 t) (Canada only) and 9989 lbs (4.531 t) (USA only)**

Permissible front axle load GAWR (FA)	Permissible rear axle load GAWR (RA)
4080 lbs (1.851 t)	7060 lbs (3.202 t)
4410 lbs (2.000 t) <sup>1)</sup>	

<sup>1)</sup> Front axle with increased load capacity.

**Gross vehicle combination weight, trailer load, tongue weight**

**Vehicle type 3500 with a maximum gross vehicle weight rating of 9900 lbs (4.490 t) (Canada only)**

Permissible gross weight for vehicle/trailer combination (GCWR) <sup>6), 9)</sup>	Gross trailer weight (GTW), braked <sup>6)</sup>	Tongue weight rating (TWR)
15250 lbs (6.917 t) <sup>3)</sup>	7500 lbs (3.402 t) <sup>3)</sup>	750 lbs (0.340 t) <sup>3)</sup>

**Vehicle type 3500 with a maximum gross vehicle weight rating of 9990 lbs (4.531 t) (USA only)**

Permissible gross weight for vehicle/trailer combination (GCWR) <sup>6), 9)</sup>	Gross trailer weight (GTW), braked <sup>6)</sup>	Tongue weight rating (TWR)
15250 lbs (6.917 t) <sup>3)</sup>	7500 lbs (3.402 t) <sup>3)</sup>	750 lbs (0.340 t) <sup>3)</sup>

<sup>3)</sup> Only NAFTA trailer cross member, towing capacity 7500 lbs (3.400 t).

<sup>6)</sup> In trailer operation, do not exceed any individual maximum permissible gross weight of those specified in the table.

<sup>9)</sup> Any vehicle not equipped with a trailer coupling as standard cannot tow a trailer. In this case, the maximum gross vehicle weight rating corresponds to the maximum permissible gross weight for the vehicle combination.

**i** If the trailer coupling is retrofitted, adapt the type plates accordingly with the altered maximum permissible weights. Please consult an authorized Mercedes-Benz Center if you have any further questions.

MERCEDES-BENZ AG	
<p><b>IMPORTANT INFORMATION FOR BODY BUILDERS</b></p> <p>This vehicle and engine conform to all applicable US EPA, CARB and Canadian regulations at the time of manufacture for vehicles &lt;UO&gt; 10000 lbs GVWR and has a maximum unloaded vehicle weight (UVW) of &lt;UVW&gt; lbs.</p>	<p><b>INFORMATIONS IMPORTANTES POUR LES CARROSSIERS</b></p> <p>Le véhicule et le moteur sont conformes aux directives EPA CARB (E.-U.) et du Canada applicables à la date de production du véhicule ayant un PNBV &lt;UO&gt; à 10000 lb et un poids à vide max. de &lt;UVW&gt; lb.</p>
A 907 584 26 05	

The bodybuilder label is found on the front-end module above the radiator and contains the vehicle's maximum permissible curb weight.

### Cargo tie-down points and carrier systems

#### Loading capacity of the cargo tie-down point and tie-down eyes

**!** **NOTE** Risk of accident if the maximum loading capacity of the cargo tie-down points is exceeded

During maximum full-stop braking, for example, forces act that can multiply the weight force of the load.

- ▶ If various cargo tie-down points are combined to secure a load, always take the maximum loading capacity of the weakest cargo tie-down point into account.
- ▶ Always use several cargo tie-down points to distribute and spread the load. Distribute the load on the cargo tie-down points evenly.

Rated tensile force is the maximum permissible tensile force.

Further information on the cargo tie-down point and tie-down eyes can be obtained in the "Transporting" section (→ page 164).

#### Tie-down eyes

##### Rated tensile force of tie-down eyes

Tie-down eyes	Rated tensile force
Cargo Van	1 798.5 lbf (800 daN)

#### Loading rails

##### Rated tensile force of cargo tie-down point in the cargo compartment

Cargo tie-down point	Rated tensile force
Loading rails on cargo floor	11 24.0 lbf (500 daN)
Lower loading rail on side wall	449.6 lbf (200 daN)
Upper loading rail on side wall	281.0 lbf (125 daN)

The values specified apply only to loads resting on the cargo floor under the following conditions:

Conditions:

- the load is secured to two cargo tie-down point on the rail
- the distance to the nearest load-securing point on the same rail is approximately 3 ft (1 m).

#### Information about roof luggage racks

**!** **WARNING** Risk of injury if maximum roof load is exceeded

The vehicle center of gravity and the usual driving characteristics as well as the steering and braking characteristics will change.

If you exceed the maximum roof load, the handling as well as steering and braking characteristics are severely affected.

- ▶ Always comply with the maximum roof load and adjust your driving style.

**!** **WARNING** Danger of accident due to uneven loading

The driving characteristics, as well as steering and braking characteristics, may be greatly impaired.

- ▶ Load the vehicle evenly.
- ▶ Secure the load against sliding.

The driving, braking and steering characteristics of the vehicle will change with the type of load, the weight and the center of gravity of the load.

**I NOTE** Risk of accident if the maximum permissible roof load is exceeded

If the weight of the roof luggage, including the roof luggage rack, exceeds the maximum permissible roof load, there will be a risk of an accident.

- ▶ Ensure that the weight of the roof luggage and roof luggage rack does not exceed the maximum permissible roof load.
- ▶ The roof luggage rack supports must be arranged at an even distance from each other.

Further information about safety measures can be found in the "Transport" section (→ page 164).

#### Max. roof load/pairs of roof luggage rack supports

Vehicles with	Maximum roof load	Minimum number of pairs of supports
Roof	661 lbs (300 kg)	6
High roof	331 lbs (150 kg)	3

This information applies if the load is distributed evenly across the entire roof area.

If the roof luggage rack is shorter, reduce the load proportionately. The maximum load per pair of roof luggage rack supports is 110 lbs (50 kg).

The loading guidelines and other information about load distribution and load securing can be found in the "Transport" section (→ page 164).

## Display messages

### Introduction

#### Function of display messages

Display messages appear on the instrument cluster.



The display messages with graphic displays can be displayed in simplified format in the Operator's Manual and may deviate from the display on the instrument cluster. The instrument cluster shows high-priority display messages in red. In addition, a warning tone sounds for specific display messages.

Act in accordance with the display messages and comply with the additional instructions in this Operator's Manual.

In addition, symbols are shown for some display messages:

 Further information

 Hide display messages

You can use the left-hand Touch Control to select between the symbols by swiping to the left or right. Pressing  displays further information on the instrument cluster. Pressing  hides the display message.

You can hide low-priority display messages by pressing the  button or with the left-hand Touch Control. The display messages are saved in the message memory.

Rectify the cause of a display message as quickly as possible.



You cannot hide high-priority display messages. The instrument cluster will show these display messages until their causes have been rectified.

#### Calling up saved display messages







On-board computer:

 Service  1 Message



If there are no display messages, **No Messages** will appear on the instrument cluster display.

-  Browse through the display messages by swiping upwards or downwards on the left-hand Touch Control.
-  **To exit the message memory:** press the  button.



## Safety systems





Display messages	Possible causes/consequences and ► Solutions
 <p data-bbox="207 390 431 467">Left Side Curtain Airbag Malfunction Service Required (example)</p>	<p data-bbox="484 301 1054 324">* The respective window air bag is malfunctioning (→ page 34).</p> <div data-bbox="505 342 1129 401" style="background-color: #f0f0f0; padding: 5px;"> <p data-bbox="514 347 1106 401">▲ <b>WARNING</b> Risk of injury or fatal injury due to a malfunction in the window curtain airbag</p> </div> <p data-bbox="518 413 1084 462">The window curtain airbag might be triggered unintentionally or might not be triggered at all in the event of an accident.</p> <div data-bbox="518 467 1093 526" style="border: 1px solid #ccc; padding: 5px;"> <p data-bbox="518 473 1093 526">► Have the window curtain airbag checked and repaired immediately at a qualified specialist workshop.</p> </div> <p data-bbox="501 544 1001 569">► Consult a qualified specialist workshop immediately.</p>
 <p data-bbox="207 672 431 749">Front Left Malfunction Service Required (example)</p>	<p data-bbox="484 582 1102 605">* The corresponding restraint system is malfunctioning (→ page 29).</p> <div data-bbox="505 623 1129 682" style="background-color: #f0f0f0; padding: 5px;"> <p data-bbox="514 628 1093 682">▲ <b>WARNING</b> Risk of injury due to malfunctions in the restraint system</p> </div> <p data-bbox="518 695 1106 743">Components in the restraint system may be activated unintentionally or not deploy as planned in an accident.</p> <div data-bbox="518 749 1093 808" style="border: 1px solid #ccc; padding: 5px;"> <p data-bbox="518 754 1093 808">► Have the restraint system checked and repaired immediately at a qualified specialist workshop.</p> </div> <p data-bbox="501 826 913 851">Recognition of a restraint system malfunction:</p> <ul data-bbox="510 861 1119 974" style="list-style-type: none"> <li data-bbox="510 861 1119 915">• The  restraint system warning lamp does not light up when the vehicle is switched on.</li> <li data-bbox="510 921 1119 974">• The  restraint system warning lamp lights up continuously or repeatedly during a journey.</li> </ul> <p data-bbox="501 987 1001 1012">► Consult a qualified specialist workshop immediately.</p>
 <p data-bbox="207 1120 431 1166">SRS Malfunction Service Required</p>	<p data-bbox="484 1030 971 1053">* The restraint system is malfunctioning (→ page 29).</p> <div data-bbox="505 1071 1129 1130" style="background-color: #f0f0f0; padding: 5px;"> <p data-bbox="514 1076 1093 1130">▲ <b>WARNING</b> Risk of injury due to malfunctions in the restraint system</p> </div> <p data-bbox="518 1143 1106 1191">Components in the restraint system may be activated unintentionally or not deploy as planned in an accident.</p> <div data-bbox="518 1197 1093 1256" style="border: 1px solid #ccc; padding: 5px;"> <p data-bbox="518 1202 1093 1256">► Have the restraint system checked and repaired immediately at a qualified specialist workshop.</p> </div> <p data-bbox="501 1274 913 1299">Recognition of a restraint system malfunction:</p> <ul data-bbox="510 1309 1119 1422" style="list-style-type: none"> <li data-bbox="510 1309 1119 1363">• The restraint system warning lamp  does not light up when the vehicle is switched on.</li> <li data-bbox="510 1369 1119 1422">• The restraint system warning lamp  lights up continuously or repeatedly during a journey.</li> </ul> <p data-bbox="501 1435 1001 1460">► Consult a qualified specialist workshop immediately.</p>



Display messages	Possible causes/consequences and ► Solutions
 <p>Parking Brake Inoperative</p>	<p>* A malfunction has occurred in the system; the parking brake is inoperative.</p> <div style="border: 1px solid gray; padding: 5px; margin-bottom: 10px;"> <p><b>▲ WARNING</b> Risk of an accident due to a brake system malfunction</p> <p>If the brake system is malfunctioning, braking characteristics may be impaired.</p> <ul style="list-style-type: none"> <li>▶ Drive on carefully.</li> <li>▶ Have the brake system checked immediately at a qualified specialist workshop.</li> </ul> </div> <ul style="list-style-type: none"> <li>▶ Park the vehicle on a level surface only and secure it against rolling away.</li> <li>▶ Have the brake system checked at a qualified specialist workshop immediately.</li> </ul>
 <p>Incline Too Steep See Operator's Manual</p>	<p>* The on-board electrical system voltage is low or a malfunction has occurred in the system; the holding force may not be sufficient for the incline.</p> <div style="border: 1px solid gray; padding: 5px; margin-bottom: 10px;"> <p><b>▲ WARNING</b> Risk of accident if the electrical parking brake has insufficient holding force</p> <p>If the electrical parking brake does not have sufficient holding force on a steep incline, the vehicle may roll away.</p> <ul style="list-style-type: none"> <li>▶ Park the vehicle on a level surface only and secure it against rolling away.</li> <li>▶ Shift the automatic transmission to position <b>P</b>.</li> </ul> </div> <p>Observe the notes on parking the vehicle (→ page 115).</p>
 <p>Parking Brake See Operator's Manual</p>	<p>* The on-board electrical system voltage is low or a malfunction has occurred in the system; the closing force may not be sufficient for the incline.</p> <div style="border: 1px solid gray; padding: 5px; margin-bottom: 10px;"> <p><b>▲ WARNING</b> Risk of an accident due to a brake system malfunction</p> <p>If the brake system is malfunctioning, braking characteristics may be impaired.</p> <ul style="list-style-type: none"> <li>▶ Drive on carefully.</li> <li>▶ Have the brake system checked immediately at a qualified specialist workshop.</li> </ul> </div> <ul style="list-style-type: none"> <li>▶ Park the vehicle on a level surface only and secure it against rolling away.</li> <li>▶ Have the brake system checked at a qualified specialist workshop immediately.</li> </ul>
<p>Check Brake Pads See Operator's Manual</p>	<p>* The brakepads have reached their wear limit.</p>





Display messages	Possible causes/consequences and ► Solutions
	<p><b>▲ WARNING</b> Risk of accident due to restricted braking power</p> <p>When the brake pads have reached their wear limit, the braking power may be restricted.</p> <ul style="list-style-type: none"> <li>► Drive on carefully.</li> <li>► Have the brake system checked immediately at a qualified specialist workshop.</li> </ul> <p>► Consult a qualified specialist workshop.</p>
 <p>Check Brake Fluid Level</p>	<p>* There is insufficient brake fluid in the brake fluid reservoir.</p> <p><b>▲ WARNING</b> Risk of an accident due to low brake fluid level</p> <p>If the brake fluid level is too low, the braking effect and the braking characteristics may be impaired.</p> <ul style="list-style-type: none"> <li>► Pull over and stop the vehicle safely as soon as possible, paying attention to road and traffic conditions. Do not continue driving under any circumstances.</li> <li>► Consult a qualified specialist workshop.</li> <li>► Do not add brake fluid.</li> </ul> <p>► Stop the vehicle immediately in accordance with the traffic conditions. Do not continue driving!</p> <p>► Contact a qualified specialist workshop.</p> <p>► Do not add brake fluid.</p>
<p>Active Brake Assist Functions Limited See Operator's Manual</p>	<p>* Active Brake Assist is malfunctioning.</p> <p>► Consult a qualified specialist workshop.</p>
<p>Active Brake Assist Functions Currently Limited See Operator's Manual</p>	<p>* Active Brake Assist is temporarily unavailable. The ambient conditions are outside the system limits (→ page 121).</p> <p>► Drive on. When the ambient conditions are within the system limits, the system will be available again.</p> <p>► If the display message does not disappear, stop the vehicle in accordance with the traffic conditions and restart it.</p>
<p>Radar Sensors Dirty See Operator's Manual</p>	<p>* The radar sensor system is malfunctioning. Possible causes:</p> <ul style="list-style-type: none"> <li>• Dirt on the sensors</li> <li>• Heavy precipitation</li> <li>• Extended country driving without other traffic, e.g. in the desert</li> </ul> <p>Driving systems and driving safety systems may be malfunctioning or temporarily unavailable.</p> <p>When the causes have been eliminated, the driving systems and driving safety systems will be available again.</p> <p>If the display message does not disappear, proceed as follows:</p> <p>► Stop in accordance with the traffic conditions.</p>



Display messages	Possible causes/consequences and ► Solutions
	<ul style="list-style-type: none"> <li>► Clean all sensors (→ page 175).</li> <li>► Restart the vehicle.</li> </ul>
<p>SOS NOT READY</p>	<p>* The emergency call system is not available. Possible causes for this include:</p> <ul style="list-style-type: none"> <li>• The vehicle is switched off.</li> <li>• The emergency call system is malfunctioning.</li> </ul> <ul style="list-style-type: none"> <li>► Switch on the vehicle. If an emergency call is unavailable, a message to this effect will appear on the instrument cluster.</li> <li>► Consult a qualified specialist workshop.</li> </ul> <p>ⓘ You can find more information on the regional availability of the emergency call system at: <a href="http://www.mercedes-benz.com/connect_ecall">http://www.mercedes-benz.com/connect_ecall</a></p>
<div style="border: 1px solid black; padding: 5px; margin-bottom: 5px; text-align: center;"> <span style="font-size: 2em; font-weight: bold;">EBD</span> </div> <div style="border: 1px solid black; padding: 5px; margin-bottom: 5px; text-align: center;">  </div> <div style="border: 1px solid black; padding: 5px; margin-bottom: 5px; text-align: center;">  </div> <p>Inoperative See Operator's Manual</p>	<p>* EBD, ABS and ESP® are malfunctioning. Other driving systems and driving safety systems may also be malfunctioning.</p> <div style="border: 1px solid gray; padding: 5px; margin-bottom: 10px;"> <p><b>⚠ WARNING</b> Risk of skidding if EBD, ABS and ESP® are malfunctioning</p> <p>The wheels may block during braking and ESP® does not perform any vehicle stabilization. The steerability and braking characteristics are heavily impaired and the braking distance may increase. In addition, other driving safety systems are switched off.</p> <ul style="list-style-type: none"> <li>► Drive on carefully.</li> <li>► Have the brake system checked immediately at a qualified specialist workshop.</li> </ul> </div> <ul style="list-style-type: none"> <li>► Drive on carefully.</li> <li>► Consult a qualified specialist workshop immediately.</li> </ul>
<div style="border: 1px solid black; padding: 5px; margin-bottom: 5px; text-align: center;">  </div> <p>Inoperative See Operator's Manual</p>	<p>* ESP® is malfunctioning. Other driving systems and driving safety systems may also be malfunctioning. The brake system continues working with the normal effect. Braking distance may increase in an emergency braking situation.</p> <div style="border: 1px solid gray; padding: 5px; margin-bottom: 10px;"> <p><b>⚠ WARNING</b> Risk of skidding if ESP® is malfunctioning</p> <p>If ESP® is malfunctioning, ESP® cannot carry out vehicle stabilization. In addition, other driving safety systems are switched off.</p> <ul style="list-style-type: none"> <li>► Drive on carefully.</li> <li>► Have ESP® checked at a qualified specialist workshop.</li> </ul> </div> <ul style="list-style-type: none"> <li>► Drive on carefully.</li> <li>► Consult a qualified specialist workshop immediately.</li> </ul>

Display messages	Possible causes/consequences and ► Solutions
 <p data-bbox="207 351 422 396">Currently Unavailable See Operator's Manual</p>	<p data-bbox="484 261 786 284">* ESP® is temporarily unavailable.</p> <p data-bbox="501 293 1093 342">Other driving systems and driving safety systems may also be malfunctioning.</p> <div data-bbox="501 360 1126 539" style="border: 1px solid gray; padding: 5px;"> <p data-bbox="514 369 1023 396"><b>▲ WARNING</b> Risk of skidding if ESP® is malfunctioning</p> <p data-bbox="518 408 1106 456">If ESP® is malfunctioning, ESP® cannot carry out vehicle stabilization. In addition, other driving safety systems are switched off.</p> <ul data-bbox="518 467 1037 526" style="list-style-type: none"> <li data-bbox="518 467 711 491">► Drive on carefully.</li> <li data-bbox="518 499 1037 526">► Have ESP® checked at a qualified specialist workshop.</li> </ul> </div> <ul data-bbox="501 551 1126 659" style="list-style-type: none"> <li data-bbox="501 551 1058 600">► Carefully drive some gentle curves at a speed greater than 19 mph (30 km/h) on a suitable stretch of road.</li> <li data-bbox="501 611 1126 659">► If the display message does not disappear, visit a qualified specialist workshop immediately. Drive carefully when doing so.</li> </ul>
  <p data-bbox="207 852 422 897">Currently Unavailable See Operator's Manual</p>	<p data-bbox="484 679 883 702">* ABS and ESP® are temporarily unavailable.</p> <p data-bbox="501 711 1115 759">Other driving systems and driving safety systems may also be temporarily unavailable.</p> <div data-bbox="501 777 1126 1089" style="border: 1px solid gray; padding: 5px;"> <p data-bbox="514 786 1102 835"><b>▲ WARNING</b> Risk of skidding if ABS and ESP® are malfunctioning</p> <p data-bbox="518 847 1102 896">The wheels may block during braking and ESP® does not perform any vehicle stabilization.</p> <p data-bbox="518 906 1093 985">The steerability and braking characteristics are heavily impaired and the braking distance may increase. In addition, other driving safety systems are switched off.</p> <ul data-bbox="518 996 1089 1076" style="list-style-type: none"> <li data-bbox="518 996 711 1019">► Drive on carefully.</li> <li data-bbox="518 1028 1089 1076">► Have ABS and ESP® checked immediately at a qualified specialist workshop.</li> </ul> </div> <ul data-bbox="501 1102 1126 1209" style="list-style-type: none"> <li data-bbox="501 1102 1058 1150">► Carefully drive some gentle curves at a speed greater than 19 mph (30 km/h) on a suitable stretch of road.</li> <li data-bbox="501 1161 1126 1209">► If the display message does not disappear, visit a qualified specialist workshop immediately. Drive carefully when doing so.</li> </ul>
  <p data-bbox="207 1408 422 1453">Inoperative See Operator's Manual</p>	<p data-bbox="484 1234 808 1257">* ABS and ESP® are malfunctioning.</p> <p data-bbox="501 1266 1093 1315">Other driving systems and driving safety systems may also be malfunctioning.</p> <p data-bbox="501 1324 1106 1372">The brake system continues working with the normal effect. Braking distance may increase in an emergency braking situation.</p> <div data-bbox="501 1390 1126 1598" style="border: 1px solid gray; padding: 5px;"> <p data-bbox="514 1399 1102 1447"><b>▲ WARNING</b> Risk of skidding if ABS and ESP® are malfunctioning</p> <p data-bbox="518 1460 1102 1508">The wheels may block during braking and ESP® does not perform any vehicle stabilization.</p> <p data-bbox="518 1519 1093 1598">The steerability and braking characteristics are heavily impaired and the braking distance may increase. In addition, other driving safety systems are switched off.</p> </div>



Display messages	Possible causes/consequences and ► Solutions
	<ul style="list-style-type: none"> <li>▶ Drive on carefully.</li> <li>▶ Have ABS and ESP® checked immediately at a qualified specialist workshop.</li> </ul> <ul style="list-style-type: none"> <li>▶ Drive on carefully.</li> <li>▶ Consult a qualified specialist workshop immediately.</li> </ul>

**Driving systems**

Display messages	Possible causes/consequences and ► Solutions
<p>CRUISE CONTROL Inoperative</p>	<ul style="list-style-type: none"> <li>* Cruise control is malfunctioning.                             <ul style="list-style-type: none"> <li>▶ Consult a qualified specialist workshop.</li> </ul> </li> </ul>
 <p>Off</p>	<ul style="list-style-type: none"> <li>* Cruise control has been deactivated.                             <p>If a warning tone also sounds, this means cruise control has deactivated itself automatically (→ page 123).</p> </li> </ul>
 <p>--- mph</p>	<ul style="list-style-type: none"> <li>* Cruise control cannot be activated as not all activation conditions have been met.                             <ul style="list-style-type: none"> <li>▶ Observe the activation conditions for cruise control (→ page 124).</li> </ul> </li> </ul>
 <p>Currently Unavailable Camera View Restricted</p>	<ul style="list-style-type: none"> <li>* The camera view is restricted. Possible causes:                             <ul style="list-style-type: none"> <li>• Dirt on the windshield in the camera's field of vision</li> <li>• Heavy precipitation or fog</li> </ul> <p>Driving systems and driving safety systems may be malfunctioning or temporarily unavailable.</p> <p>When the causes have been eliminated, the driving systems and driving safety systems will be available again.</p> <p>If the display message does not disappear:</p> <ul style="list-style-type: none"> <li>▶ Stop in accordance with the traffic conditions.</li> <li>▶ Clean the windshield.</li> <li>▶ If necessary, consult a qualified specialist workshop.</li> </ul> </li> </ul>
 <p>OFF</p> <p>Currently Unavailable Radar Sensors Dirty</p>	<ul style="list-style-type: none"> <li>* The radar sensor system is malfunctioning. Possible causes:                             <ul style="list-style-type: none"> <li>• Dirt on the sensors</li> <li>• Heavy precipitation</li> <li>• Extended country driving without other traffic, e.g. in the desert</li> </ul> <p>The following systems may be affected:</p> <ul style="list-style-type: none"> <li>• Active Distance Assist DISTRONIC</li> <li>• Blind Spot Assist (→ page 129)</li> <li>• Active Brake Assist (→ page 121)</li> </ul> <p>Driving systems and driving safety systems may be malfunctioning or temporarily unavailable.</p> </li> </ul>



Display messages	Possible causes/consequences and ► Solutions
	<p>When the causes have been eliminated, the driving systems and driving safety systems will be available again.</p> <p>If the display message does not disappear:</p> <ul style="list-style-type: none"> <li>► Stop in accordance with the traffic conditions.</li> <li>► Clean all sensors (→ page 175).</li> <li>► Restart the vehicle.</li> <li>► If necessary, consult a qualified specialist workshop.</li> </ul>
 <p>Off</p>	<p>* The HOLD function has been deactivated because the vehicle is slipping or an activation condition has not been met.</p> <ul style="list-style-type: none"> <li>► Reactivate the HOLD function later on or check the HOLD function's activation conditions (→ page 125).</li> </ul>
<p>Blind Spot Assist Inoperative</p>	<p>* Blind Spot Assist is malfunctioning (→ page 129).</p> <ul style="list-style-type: none"> <li>► Consult a qualified specialist workshop.</li> </ul>
<p>Blind Spot Assist Trailer Not Monitored</p>	<p>* When you establish an electrical connection with the trailer, Blind Spot Assist will remain available but the area beside the trailer will not be monitored. The function of Blind Spot Assist may be restricted as a result (→ page 129).</p> <ul style="list-style-type: none"> <li>► Press the left-hand Touch Control and acknowledge the display message.</li> </ul>
<p>Blind Spot Assist Currently Unavailable See Operator's Manual</p>	<p>* Blind Spot Assist is temporarily unavailable (→ page 129). The system limits have been reached (→ page 129).</p> <ul style="list-style-type: none"> <li>► Drive on. When the causes have been eliminated, the system will be available again.</li> </ul> <p>or</p> <ul style="list-style-type: none"> <li>► If the display message does not disappear, stop the vehicle in accordance with the traffic conditions and restart it.</li> <li>► If necessary, clean the rear bumper. If the bumper is very dirty, the sensors in the bumper may malfunction.</li> </ul>
 <p>Attention Assist Inoperative</p>	<p>* ATTENTION ASSIST is malfunctioning.</p> <ul style="list-style-type: none"> <li>► Consult a qualified specialist workshop.</li> </ul>
 <p>Attention Assist: Take a Break!</p>	<p>* ATTENTION ASSIST has detected fatigue or increasing inattentiveness on the driver's part (→ page 128).</p> <ul style="list-style-type: none"> <li>► If necessary, take a break.</li> </ul>

Climate control







Display messages	Possible causes/consequences and ► Solutions
Pre-entry Climate Control Available Again via Week Profile after Vehicle Start	<ul style="list-style-type: none"> <li>* Pre-entry climate control was activated more than three times during a week profile without a journey taking place. The function has been deactivated in order to conserve energy.                             <ul style="list-style-type: none"> <li>► Start the vehicle for ten seconds. Pre-entry climate control is operational again.</li> </ul> </li> </ul>
Pre-entry Climate Control Available Again via SmartKey after Vehicle Start	<ul style="list-style-type: none"> <li>* You have attempted to switch on pre-entry climate control more than three times with the engine switched off.                             <ul style="list-style-type: none"> <li>► Let the vehicle run for ten seconds. Pre-entry climate control is operational again.</li> </ul> </li> </ul>
 <p>Currently unavailable High-voltage battery charging not completed</p>	<ul style="list-style-type: none"> <li>* The high-voltage battery is charging. Pre-entry climate control cannot be switched on.                             <ul style="list-style-type: none"> <li>► Wait until the charging process has achieved a minimum charge.</li> </ul> </li> </ul>
 <p>Currently unavailable Charge high-voltage battery</p>	<ul style="list-style-type: none"> <li>* The high-voltage battery's state of charge is too low. Pre-entry climate control cannot be switched on.                             <ul style="list-style-type: none"> <li>► Charge the high-voltage battery (→ page 106).</li> </ul> </li> </ul>
Pre-Entry Climate Ctrl. (Via SmartKey) Inoperative HV Battery Low	<ul style="list-style-type: none"> <li>* The high-voltage battery's state of charge is too low. Pre-entry climate control cannot be switched on.                             <ul style="list-style-type: none"> <li>► Charge the high-voltage battery (→ page 106). When the high-voltage battery is sufficiently charged, pre-entry climate control will be operational again.</li> </ul> </li> </ul>





Drive system

Display messages	Possible causes/consequences and ► Solutions
Wait in READY State Battery Is Warming Up See Operator's Manual	<ul style="list-style-type: none"> <li>* Operational readiness is established [READY] and the drive range [P] is engaged.                             <p>The high-voltage battery is being warmed up to the operating temperature. The heating process takes a few minutes; cabin climate control and the DEFROST function are restricted.</p> <p>The heating process ends when drive range [D] is engaged. When you are driving, however, the output will be significantly limited until the high-voltage battery has reached its operating temperature.</p> </li> </ul>
Battery calibration required AC charging at state of charge: max. XXX% Outside temperature: min. XX°C	<ul style="list-style-type: none"> <li>* The high-voltage battery is not calibrated.                             <ul style="list-style-type: none"> <li>► Calibrate the high-voltage battery (→ page 168).</li> </ul> </li> </ul>

Display messages	Possible causes/consequences and ► Solutions
To guarantee max. range, carry out battery calibration Begin charging process up to 100%	<ul style="list-style-type: none"> <li>* The high-voltage battery is not calibrated.               <ul style="list-style-type: none"> <li>► Calibrate the high-voltage battery (→ page 168).</li> </ul> </li> </ul>
To guarantee max. range, carry out battery calibration Charging time extension: X min Begin AC charging up to 100%	<ul style="list-style-type: none"> <li>* The high-voltage battery is not calibrated.               <ul style="list-style-type: none"> <li>► Calibrate the high-voltage battery (→ page 168).</li> </ul> </li> </ul>
 <p>High-volt. Bat. Overheat. Stop, everyone out! Outside if Poss.</p>	<ul style="list-style-type: none"> <li>* The high-voltage battery has overheated. There is a risk of fire.               <ul style="list-style-type: none"> <li>► Stop the vehicle immediately in accordance with the traffic conditions.</li> <li>► If possible, park the vehicle in the outdoors and make sure that all occupants exit the vehicle.</li> <li>► Do not drive on.</li> <li>► If smoke develops, leave the danger zone and call the fire service immediately.</li> <li>► Consult a qualified specialist workshop even if there are no external signs of a fire.</li> </ul> </li> </ul>
 <p>High-volt. Bat. Overheated Stop now, outside if poss.</p>	<ul style="list-style-type: none"> <li>* The high-voltage battery has overheated. There is a risk of fire.               <ul style="list-style-type: none"> <li>► Stop the vehicle immediately in accordance with the traffic conditions.</li> <li>► If possible, stop the vehicle in the open air and ensure that all vehicle occupants get out.</li> <li>► Do not drive on.</li> <li>► If smoke is present, leave the danger zone and call the fire service immediately.</li> <li>► Consult a qualified specialist workshop even if there are no external signs of a fire.</li> </ul> </li> </ul>
High-voltage battery maintenance urgently required. Do Not Restart And Consult Dealer	<ul style="list-style-type: none"> <li>* The high voltage battery has reached the end of its service life. (→ page 168). Do not switch off the drive system. If you do, a restart will generally not be possible.               <ul style="list-style-type: none"> <li>► Have the necessary maintenance work on the high-voltage battery carried out at a qualified specialist workshop.</li> </ul> </li> </ul>
Note the range. Visit a workshop.	<ul style="list-style-type: none"> <li>* A battery from the battery pack is malfunctioning.               <ul style="list-style-type: none"> <li>► Consult a qualified specialist workshop.</li> <li>► Note the changed range.</li> </ul> </li> </ul>
Note the range	<ul style="list-style-type: none"> <li>* The useful capacity of the high-voltage battery system has changed.               <ul style="list-style-type: none"> <li>► Note the changed range that is displayed.</li> </ul> </li> </ul>





Display messages	Possible causes/consequences and ► Solutions
 <p>Charger Cable Connected</p>	<ul style="list-style-type: none"> <li>* You cannot pull away while the charging cable is connected.                             <ul style="list-style-type: none"> <li>► Disconnect the charging cable from the vehicle.</li> </ul> </li> </ul>
 <p>Reserve Level Charge High-Voltage Battery</p>	<ul style="list-style-type: none"> <li>* The charge level of the high-voltage battery has reached the reserve level.                             <ul style="list-style-type: none"> <li>► Charge the high-voltage battery (→ page 106).</li> </ul> </li> </ul>
 <p>Towing Not Permitted See Operator's Manual</p>	<ul style="list-style-type: none"> <li>* The drive system is malfunctioning.                             <ul style="list-style-type: none"> <li>► Have the vehicle transported only using a transporter or trailer (→ page 183).</li> </ul> </li> </ul>
<p>Reduced Drive System Performance See Operator's Manual</p>	<ul style="list-style-type: none"> <li>* The drive system is outside the operating temperature range, e.g. due to extreme outside temperatures. Drive system power output is reduced.                             <ul style="list-style-type: none"> <li>► Drive on carefully. Once the operating conditions return to normal, the full output will be available again.</li> </ul> </li> <li>* The high-voltage battery is not charged sufficiently. Drive system power output is reduced.                             <ul style="list-style-type: none"> <li>► Drive on carefully.</li> <li>► Charge the high-voltage battery immediately (→ page 106).</li> </ul> </li> <li>* If the drive system power output is still reduced, there is a malfunction in the drive system.                             <ul style="list-style-type: none"> <li>► Drive on carefully.</li> <li>► Consult a qualified specialist workshop.</li> </ul> </li> </ul>
 <p>Malfunction</p>	<ul style="list-style-type: none"> <li>* The drive system is malfunctioning. A warning tone also sounds.                             <ul style="list-style-type: none"> <li>► Consult a qualified specialist workshop.</li> </ul> </li> <li>* There is a serious malfunction if the display message and warning tone are repeated at short intervals. You must stop the vehicle immediately in accordance with the traffic conditions because the drive system is automatically deactivated.                             <ul style="list-style-type: none"> <li>► Stop the vehicle immediately in accordance with the traffic conditions.</li> <li>► Switch off the vehicle and consult a qualified specialist workshop.</li> </ul> </li> </ul>
 <p>s. Operating Instructions</p>	<ul style="list-style-type: none"> <li>* In addition, the  indicator lamp on the instrument cluster lights up. The 12 V battery is no longer being charged.                             <ul style="list-style-type: none"> <li>► Stop immediately in accordance with the traffic conditions and switch off the drive system.</li> </ul> </li> </ul>





Display messages	Possible causes/consequences and ► Solutions
	<ul style="list-style-type: none"> <li>► Secure the vehicle against rolling away (→ page 115).</li> <li>► Do not drive on.</li> <li>► Consult a qualified specialist workshop.</li> </ul>
 <p>Stop Immediately Drive will be deactivated Charge high-voltage battery</p>	<ul style="list-style-type: none"> <li>* The charge level of the high-voltage battery is so low that driving is no longer possible. <ul style="list-style-type: none"> <li>► Park the vehicle and charge the high-voltage battery (→ page 106).</li> </ul> </li> </ul>
 <p>Malfunction Consult a workshop</p>	<ul style="list-style-type: none"> <li>* There are malfunctions in the drive and/or cooling system. <ul style="list-style-type: none"> <li>► Consult a qualified specialist workshop.</li> </ul> </li> </ul>
<p>Do Not Restart Vehicle Service Required</p>	<ul style="list-style-type: none"> <li>* A malfunction has occurred in the high-voltage on-board electrical system. A warning tone also sounds. <ul style="list-style-type: none"> <li>► Do not switch off the drive system.</li> <li>► Consult a qualified specialist workshop immediately.</li> </ul> </li> </ul>
 <p>Stop Switch Engine Off</p>	<ul style="list-style-type: none"> <li>* There is a serious malfunction in the drive system. A warning tone also sounds. <ul style="list-style-type: none"> <li>► Stop the vehicle immediately in accordance with the traffic conditions. Do not continue driving!</li> <li>► Consult a qualified specialist workshop immediately.</li> </ul> </li> </ul>
 <p>Acoustic Presence Indicator Inoperative</p>	<ul style="list-style-type: none"> <li>* The sound generator (acoustic vehicle alerting system) is malfunctioning. No driving noises are being produced. As a result, your vehicle may not be heard by other road users in certain situations. <ul style="list-style-type: none"> <li>► Drive with particular care.</li> <li>► Consult a qualified specialist workshop.</li> </ul> </li> </ul>

## Tires

Display messages	Possible causes/consequences and ► Solutions
<p>Tire Pressure Monitor Inoperative No Wheel Sensors</p>	<ul style="list-style-type: none"> <li>* The wheels installed do not have suitable tire pressure sensors. The tire pressure monitoring system is deactivated. <ul style="list-style-type: none"> <li>► Install wheels with suitable tire pressure sensors.</li> </ul> </li> </ul>
 <p>Wheel Sensor(s) Missing</p>	<ul style="list-style-type: none"> <li>* There is no signal from the tire pressure sensor of at least one tire. No pressure value is displayed for the tire in question. <ul style="list-style-type: none"> <li>► Have the faulty tire pressure sensor replaced at a qualified specialist workshop.</li> </ul> </li> </ul>
<p>Tire Press. Monitor Currently Unavailable</p>	<ul style="list-style-type: none"> <li>* There is interference from a powerful radio signal source. As a result, no signals from the tire pressure sensor are received. The tire pressure monitoring system is temporarily unavailable.</li> </ul>



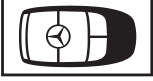

Display messages	Possible causes/consequences and ► Solutions
	<p>► Drive on. The tire pressure monitoring system will restart automatically as soon as the cause has been rectified.</p>
 <p>Warning Tire Malfunction</p>	<p>* The tire pressure in one or more tires has dropped suddenly. The wheel position is shown.</p> <div style="border: 1px solid gray; padding: 5px;"> <p><b>▲ WARNING</b> Risk of an accident from driving with a flat tire</p> <ul style="list-style-type: none"> <li>• The tires can overheat and cause a fire.</li> <li>• The driving characteristics as well as the steering and braking may be greatly impaired.</li> </ul> <p>You could then lose control of the vehicle.</p> <ul style="list-style-type: none"> <li>► Do not drive on with a flat tire.</li> <li>► Observe the notes on flat tires.</li> </ul> </div> <p>Information about flat tire (→ page 181).</p> <ul style="list-style-type: none"> <li>► Stop the vehicle in accordance with the traffic conditions.</li> <li>► Check the tires.</li> </ul>
 <p>Check Tires</p>	<p>* The tire pressure in one or more tires has dropped significantly. The wheel position is shown.</p> <div style="border: 1px solid gray; padding: 5px;"> <p><b>▲ WARNING</b> Risk of an accident due to insufficient tire pressure</p> <ul style="list-style-type: none"> <li>• The tires can burst.</li> <li>• The tires can wear excessively and/or unevenly.</li> <li>• The driving characteristics as well as the steering and braking may be greatly impaired.</li> </ul> <p>You could then lose control of the vehicle.</p> <ul style="list-style-type: none"> <li>► Observe the recommended tire pressures.</li> <li>► Adjust the tire pressure if necessary.</li> </ul> </div> <ul style="list-style-type: none"> <li>► Stop in accordance with the traffic conditions.</li> <li>► Check the tire pressure (→ page 192) and the tires.</li> </ul>
 <p>Please Correct Tire Pressure</p>	<p>* The tire pressure is too low in at least one tire, or the difference in tire pressure between the individual wheels is too great.</p> <ul style="list-style-type: none"> <li>► Check the tire pressure, and add air if necessary.</li> <li>► When the tire pressure has been set correctly, re-start the tire pressure monitoring system (→ page 196).</li> </ul>
<p>Tire Pressure Monitor Inoperative</p>	<p>* The tire pressure monitoring system is malfunctioning.</p> <ul style="list-style-type: none"> <li>► Consult a qualified specialist workshop.</li> </ul>

## Key



Display messages	Possible causes/consequences and ► Solutions
 <p>Don't Forget Your Key</p>	<p>* This message reminds you not to leave your key in the vehicle.</p> <ul style="list-style-type: none"> <li>► Take the key with you when you get out of the vehicle.</li> </ul>
<p>Place Key in Marked Space See Operator's Manual</p>	<p>* Key detection is malfunctioning.</p> <ul style="list-style-type: none"> <li>► Change the key's position in the vehicle.</li> <li>► Start the vehicle with the key in the marked space (→ page 97).</li> </ul>
 <p>Key Not Detected (red display message)</p>	<p>* The key is not detected and may no longer be in the vehicle. The key is no longer in the vehicle and you switch off the vehicle:</p> <ul style="list-style-type: none"> <li>• You can no longer start the vehicle.</li> <li>• You cannot lock the vehicle centrally.</li> </ul> <p>► Ensure that the key is in the vehicle.</p> <p>If the key detection function is malfunctioning due to a strong radio signal source, proceed as follows:</p> <ul style="list-style-type: none"> <li>► Stop the vehicle immediately in accordance with the traffic conditions.</li> <li>► Place the key in the slot for starting with the key (→ page 97).</li> </ul>
 <p>Key Not Detected (white display message)</p>	<p>* The key is currently not detected.</p> <ul style="list-style-type: none"> <li>► Change the key's position in the vehicle.</li> <li>► If the key is still not detected, start the vehicle with the key in the slot (→ page 97).</li> </ul>
 <p>Replace Key Battery</p>	<p>* The key battery is flat.</p> <ul style="list-style-type: none"> <li>► Replace the battery (→ page 40).</li> </ul>
 <p>Obtain a New Key</p>	<p>* The key needs to be replaced.</p> <ul style="list-style-type: none"> <li>► Consult a qualified specialist workshop.</li> </ul>

## Vehicle

Display messages	Possible causes/consequences and ► Solutions
<p>Air Con. Energy Saving Mode Activ.</p>	<p>* The air-conditioning energy-saving mode is active (→ page 87)</p>
<p>Socket flap open</p>	<p>* The socket flap is open.</p> <ul style="list-style-type: none"> <li>► Close the socket flap.</li> </ul>



Display messages	Possible causes/consequences and ► Solutions
 <p>Refill Washer Fluid</p>	<p>* The washer fluid level in the washer fluid reservoir has dropped below the minimum.</p> <ul style="list-style-type: none"> <li>► Add washer fluid (→ page 173).</li> </ul> <p>If the display message still appears:</p> <ul style="list-style-type: none"> <li>► Consult a qualified specialist workshop.</li> </ul>
	<p>* At least one door is open.</p> <ul style="list-style-type: none"> <li>► Close all the doors.</li> </ul>
	<p>* The hood is open.</p> <div style="border: 1px solid black; padding: 5px; margin: 10px 0;"> <p><b>▲ WARNING</b> Risk of accident due to driving with the hood unlocked</p> <p>The hood may open and block your view.</p> <ul style="list-style-type: none"> <li>► Never release the hood when driving.</li> <li>► Before every trip, ensure that the hood is locked.</li> </ul> </div> <ul style="list-style-type: none"> <li>► Stop the vehicle immediately in accordance with the traffic conditions.</li> <li>► Close the hood.</li> </ul>
 <p>Steering Malfunction Increased Physical Effort See Operator's Manual</p>	<p>* The steering power assistance is malfunctioning.</p> <div style="border: 1px solid black; padding: 5px; margin: 10px 0;"> <p><b>▲ WARNING</b> Risk of an accident due to altered steering characteristics</p> <p>If the power assistance of the steering fails partially or completely, you will need to use more force to steer.</p> <ul style="list-style-type: none"> <li>► If safe steering is possible, drive on carefully.</li> <li>► Visit or consult a qualified specialist workshop immediately.</li> </ul> </div> <ul style="list-style-type: none"> <li>► If safe steering is possible, drive on carefully.</li> <li>► Visit or consult a qualified specialist workshop immediately.</li> </ul>
 <p>Steering Malfunction Stop Immediately See Operator's Manual</p>	<p>* The steering is malfunctioning. Steerability is heavily impaired.</p> <div style="border: 1px solid black; padding: 5px; margin: 10px 0;"> <p><b>▲ WARNING</b> Risk of accident if steering capability is impaired</p> <p>If the steering does not function as intended, the vehicle's operating safety is jeopardized.</p> <ul style="list-style-type: none"> <li>► Pull over and stop the vehicle safely as soon as possible, paying attention to road and traffic conditions. Do not continue driving under any circumstances.</li> <li>► Consult a qualified specialist workshop.</li> </ul> </div> <ul style="list-style-type: none"> <li>► Stop the vehicle immediately in accordance with the traffic conditions. Do not continue driving!</li> <li>► Contact a qualified specialist workshop.</li> </ul>
<p>Shift to 'P' or 'N' to Start Engine</p>	<p>* You have attempted to start the vehicle in drive range <b>D</b> or <b>R</b>.</p> <ul style="list-style-type: none"> <li>► Select drive range <b>P</b> or <b>N</b>.</li> </ul>

Display messages	Possible causes/consequences and ► Solutions
To Engage Transmiss. Position R First Depress the Brake	<ul style="list-style-type: none"> <li>* You have attempted to shift from position <b>[D]</b> or <b>[N]</b> to position <b>[R]</b>.               <ul style="list-style-type: none"> <li>► Depress the brake pedal.</li> <li>► Shift the transmission to position <b>[R]</b>.</li> </ul> </li> </ul>
Auxiliary Battery Mal- function	<ul style="list-style-type: none"> <li>* The auxiliary battery for the transmission is no longer being charged.               <ul style="list-style-type: none"> <li>► Consult a qualified specialist workshop.</li> <li>► Until then, always shift the transmission to position <b>[P]</b> manually before you switch off the engine.</li> <li>► Before leaving the vehicle, apply the parking brake.</li> </ul> </li> </ul>
Reversing Not Possible: Service Required	<ul style="list-style-type: none"> <li>* The transmission is malfunctioning. It is no longer possible to select reverse gear.               <ul style="list-style-type: none"> <li>► Consult a qualified specialist workshop.</li> </ul> </li> </ul>
 Vehicle Operational Switch the Ignition Off Before Exiting	<ul style="list-style-type: none"> <li>* You are about to exit the vehicle when it is in a ready-to-drive state.               <ul style="list-style-type: none"> <li>► When you exit the vehicle, switch off the vehicle and take the key with you.</li> </ul> </li> </ul>
Do Not Change Trans- mission Position Service Required	<ul style="list-style-type: none"> <li>* The transmission is malfunctioning or there is a malfunction in the high-voltage on-board electrical system.               <ul style="list-style-type: none"> <li>► If transmission position <b>[D]</b> is selected, consult a qualified specialist workshop and do not change the transmission position.</li> <li>► For all other transmission positions, park the vehicle in a safe location.</li> <li>► Inform a qualified specialist workshop or breakdown service.</li> </ul> </li> </ul>
Only Shift to 'P' when Vehicle is Stationary	<ul style="list-style-type: none"> <li>* The transmission can be shifted to position <b>[P]</b> only when the vehicle is at a standstill.</li> </ul>
To Deselect P or N, Depress Brake and Start Engine	<ul style="list-style-type: none"> <li>* You have attempted to shift out of drive range <b>[P]</b> or <b>[N]</b> into another drive range.               <ul style="list-style-type: none"> <li>► Depress the brake pedal.</li> <li>► Start the drive system.</li> </ul> </li> </ul>
Apply Brake to Shift from 'P'	<ul style="list-style-type: none"> <li>* You have attempted to shift out of drive range <b>[P]</b> and into another drive range.               <ul style="list-style-type: none"> <li>► Depress the brake pedal.</li> </ul> </li> </ul>
N Permanently Active Risk of Rolling Away	<ul style="list-style-type: none"> <li>* Drive range <b>[N]</b> has been selected while the vehicle is rolling or being driven.               <ul style="list-style-type: none"> <li>► To stop, depress the brake pedal and engage drive range <b>[P]</b> while the vehicle is stationary.</li> <li>► To continue your journey, select drive range <b>[D]</b> or <b>[R]</b>.</li> </ul> </li> </ul>
Risk of Rolling Driver's Door Open and Transmis- sion Not in P	<ul style="list-style-type: none"> <li>* The driver's door is not fully closed and drive range <b>[R]</b>, <b>[N]</b> or <b>[D]</b> is selected.               <ul style="list-style-type: none"> <li>► When you park the vehicle, select drive range <b>[P]</b> and additionally secure the vehicle using the parking brake.</li> </ul> </li> </ul>



Display messages	Possible causes/consequences and ► Solutions
<p>Risk of rolling, driver's seat not occupied and transmission not in P</p>	<p>* Driver's seat detection does not detect a person on the driver's seat and drive range <b>R</b>, <b>N</b> or <b>D</b> is selected.</p> <p>► When you park the vehicle and leave the driver's seat, select drive range <b>P</b> and additionally secure the vehicle using the parking brake.</p>
 <p>Veh. Tracking Activated See Op. Manual or mobile app</p>	<p>* The vehicle has activated services from Mercedes me at its disposal. Locating the vehicle may be possible using Mercedes me connect.</p> <p>► Check the status of the activated services at <a href="http://mercedes.me">http://mercedes.me</a>.</p> <p>► Ask the vehicle owner for the details.</p> <p>► <b>Vehicles with MBUX and navigation:</b> deactivate Vehicle Tracker via the system settings.</p>
<p>Transmission Malfunction: Stop Vehicle</p>	<p>* The transmission is malfunctioning. The transmission automatically shifts to position <b>N</b>.</p> <p>► Stop the vehicle immediately in accordance with the traffic conditions.</p> <p>► Shift the transmission to position <b>P</b>.</p> <p>► Consult a qualified specialist workshop.</p>
 <p>Please charge the high-voltage battery; ability to start otherwise not guaranteed</p>	<p>* Due to a possible drop in the temperature of the high-voltage battery, the starting ability or the range may drop significantly until the vehicle is restarted.</p> <p>► Charge the high-voltage battery (→ page 106).</p>
 <p>Coolant malfunction, stop vehicle immediately</p>	<p>* The coolant is too hot.</p> <p>► Stop the vehicle immediately in accordance with the traffic conditions and switch off the drive system.</p> <div style="border: 1px solid gray; padding: 5px; margin-top: 10px;"> <p><b>▲ WARNING</b> Risk of injury due to overheated vehicle</p> <p>If you open the hood in the event of an overheated vehicle or fire in the engine compartment, the following situations may occur:</p> <ul style="list-style-type: none"> <li>• You may come into contact with hot gases.</li> <li>• You may come into contact with other escaping hot operating fluids.</li> </ul> <p>► In the event of overheating or fire in the engine compartment, keep the hood closed and call the fire service.</p> <p>► Allow the overheated vehicle to cool down first if you need to open the hood.</p> </div> <p>► Wait until the drive system has cooled down.</p> <p>► Make sure that the air supply to the vehicle radiator is not obstructed.</p>

Display messages	Possible causes/consequences and ► Solutions
 <p>Refill Coolant See Operator's Manual</p>	<ul style="list-style-type: none"> <li>► Avoiding high loads on the drive system, drive to the nearest qualified specialist workshop.</li> </ul> <p>* The coolant level is too low.</p> <div style="border: 1px solid black; padding: 5px;"> <p><b>!</b> <b>NOTE</b> Damage to the drive system due to insufficient coolant</p> <ul style="list-style-type: none"> <li>► Avoid long journeys with insufficient coolant.</li> </ul> </div> <ul style="list-style-type: none"> <li>► Have the cooling system of the drive system checked at a qualified specialist workshop.</li> </ul>

## Lights

Display messages	Possible causes/consequences and ► Solutions
<p>Adaptive Highbeam Assist Camera View Restricted See Operator's Manual</p>	<p>* The camera view is restricted. Possible causes:</p> <ul style="list-style-type: none"> <li>• dirt on the windshield in the camera's field of vision</li> <li>• heavy precipitation or fog</li> </ul> <p>Driving systems and driving safety systems may be malfunctioning or temporarily unavailable.</p> <p>When the causes have been eliminated, the driving systems and driving safety systems will be available again.</p> <p>If the display message does not disappear:</p> <ul style="list-style-type: none"> <li>► Stop in accordance with the traffic conditions.</li> <li>► Clean the windshield.</li> </ul>
<p>Adaptive Highbeam Assist Currently Unavailable See Operator's Manual</p>	<p>* Adaptive Highbeam Assist is temporarily unavailable. The system limits have been reached (→ page 74).</p> <ul style="list-style-type: none"> <li>► Drive on. When the causes have been eliminated, the system will be available again. The display message <b>Adaptive Highbeam Assist Now Available</b> appears.</li> </ul>
<p>Adaptive Highbeam Assist Inoperative</p>	<p>* Adaptive Highbeam Assist is malfunctioning.</p> <ul style="list-style-type: none"> <li>► Consult a qualified specialist workshop.</li> </ul>
 <p>Switch On Headlamps</p>	<p>* You are driving without low beam.</p> <ul style="list-style-type: none"> <li>► Turn the light switch to the  position.</li> </ul> <p>or</p> <ul style="list-style-type: none"> <li>► Turn the light switch to the <b>AUTO</b> position.</li> </ul>
 <p>Switch Off Lights</p>	<p>* You are leaving the vehicle and the light is still switched on.</p> <ul style="list-style-type: none"> <li>► Turn the light switch to the <b>AUTO</b> position.</li> </ul>

















Display messages	Possible causes/consequences and ► Solutions
 AUTO Lamp Function Inoperative	* The light sensor is malfunctioning. ► Consult a qualified specialist workshop.
 Malfunction See Operator's Manual	* The exterior lighting is malfunctioning. ► Consult a qualified specialist workshop. * <b>Vehicles with trailer hitch:</b> a fuse may have blown. ► Stop in accordance with the traffic conditions. ► Check the fuses, and replace them if necessary(→ page 186).
 Low Beam Left (example)	* The corresponding light source is defective. ► Consult a qualified specialist workshop. or ► Check whether changing the bulb is permitted.











### Indicator and warning lamps

#### Overview of indicator and warning lamps









Some systems will perform a self-test when the vehicle is switched on. Some indicator and warning lamps may briefly light up or flash. This behavior is non-critical. These indicator and warning lamps indicate a malfunction only if they light up or flash after the vehicle has been started or during a journey.









#### Indicator and warning lamps:







-  Low beam (→ page 71)
-  Standing lights (→ page 71)
-  High beam (→ page 72)
-  Turn signal lights (→ page 72)
-  Rear fog light (→ page 71)
-  Seat belt not fastened (→ page 251)
-  USA: Brakes (red) (→ page 246)
-  Canada: Brakes (red) (→ page 246)
-  Brakes (yellow) (→ page 246)
-  ABS malfunction (→ page 246)
-  ESP® (→ page 246)
-  ESP® OFF (→ page 246)
-  Active Brake Assist switched off (→ page 121)
-  USA: Electric parking brake applied (red) (→ page 246)



-  Canada: Electric parking brake applied (red) (→ page 246)
-  Electric parking brake (yellow) (→ page 246)
-  Electric power steering malfunction (→ page 252)
-  Electrical malfunction
-  Restraint system (→ page 246)
-  Engine diagnosis
-  Coolant too hot/cold
-  Distance warning (→ page 252)
-  Preglow
-  Tire pressure monitoring system (→ page 194)





## Safety systems

Warning/indicator lamp	Possible causes/consequences and ► Solutions
 <p>and</p>  <p>Electric parking brake applied red indicator lamp (USA) does not light up</p>  <p>Electric parking brake applied red indicator lamp (Canada) does not light up</p>  <p>Electric parking brake malfunctioning yellow indicator lamp lights up</p>	<p><b>*Vehicles with electric parking brake:</b> the red electric parking brake indicator lamp does not light up. The yellow electric parking brake indicator lamp lights up.</p> <p>Meaning of the indicator lamps:</p> <ul style="list-style-type: none"> <li>• The red indicator lamp does not light up: the electric parking brake has been released.</li> <li>• The yellow indicator lamp lights up: the electric parking brake is malfunctioning.</li> </ul> <ul style="list-style-type: none"> <li>► Note the messages on the instrument cluster.</li> <li>► Switch the vehicle off and on.</li> <li>► If the fault message persists, consult a qualified specialist workshop.</li> <li>► Park the vehicle only on level ground and secure it against rolling away (→ page 116).</li> </ul>
 <p>and</p>  <p>Red electric parking brake applied indicator lamp (USA) lights up</p>  <p>Red electric parking brake applied indicator lamp (Canada) lights up</p>  <p>Electric parking brake malfunctioning yellow indicator lamp lights up</p>	<p><b>*Vehicles with electric parking brake:</b> the red and yellow electric parking brake indicator lamps light up.</p> <p>Meaning of the indicator lamps:</p> <ul style="list-style-type: none"> <li>• The red electric parking brake indicator lamp lights up: the electric parking brake has been applied.</li> <li>• The yellow electric parking brake indicator lamp lights up: the electric parking brake is malfunctioning.</li> </ul> <ul style="list-style-type: none"> <li>► Note the messages on the instrument cluster.</li> <li>► Switch the vehicle off and on.</li> <li>► If the fault message persists, consult a qualified specialist workshop.</li> <li>► If it is not possible to release the electric parking brake, do not drive the vehicle.</li> </ul>

Warning/indicator lamp	Possible causes/consequences and ► Solutions
 <p>and</p>  <p>Red electric parking brake applied indicator lamp (USA) flashes</p>  <p>Red electric parking brake applied indicator lamp (Canada) flashes</p>  <p>Electric parking brake malfunctioning yellow indicator lamp lights up</p>	<p><b>*Vehicles with electric parking brake:</b> the red electric parking brake indicator lamp flashes. The yellow electric parking brake indicator lamp lights up.</p> <p>Meaning of the indicator lamps:</p> <ul style="list-style-type: none"> <li>• The red electric parking brake indicator lamp flashes: the activation status of the electric parking brake is unknown.</li> <li>• The yellow electric parking brake indicator lamp lights up: the electric parking brake is malfunctioning.</li> </ul> <ul style="list-style-type: none"> <li>► Note the messages on the instrument cluster.</li> <li>► Switch the vehicle off and on.</li> <li>► Engage and release the electric parking brake using the switch while depressing the brake pedal.</li> <li>► If the fault message persists, park the vehicle on level ground and secure it against rolling away (→ page 116).</li> <li>► Consult a qualified specialist workshop.</li> <li>► Do not drive the vehicle when the red indicator lamp is flashing, as the brake system may overheat.</li> </ul>
 <p>and</p>  <p>Red electric parking brake applied indicator lamp (USA) lights up</p>  <p>Red electric parking brake applied indicator lamp (Canada) lights up</p>  <p>The electric parking brake malfunctioning yellow indicator lamp does not light up</p>	<p><b>*Vehicles with electric parking brake:</b> the electric parking brake red indicator lamp lights up. The electric parking brake yellow indicator lamp does not light up.</p> <p>Meaning of the indicator lamps:</p> <ul style="list-style-type: none"> <li>• The electric parking brake red indicator lamp lights up: the electric parking brake has been applied.</li> <li>• The electric parking brake yellow indicator lamp does not light up: there are no faults with the electric parking brake.</li> </ul> <ul style="list-style-type: none"> <li>► Do not drive the vehicle if the electric parking brake has been applied.</li> </ul>



Warning/indicator lamp	Possible causes/consequences and ► Solutions
 <p>and</p>  <p>Red parking brake applied indicator lamp (USA) lights up</p>  <p>Red parking brake applied indicator lamp (Canada) lights up</p>	<p>*<b>Vehicles with manual parking brake:</b> the parking brake red indicator lamp lights up.</p> <p>Meaning of the indicator lamp:</p> <ul style="list-style-type: none"> <li>• The parking brake red indicator lamp lights up: the parking brake has been applied.</li> </ul> <p>► Do not drive the vehicle if the parking brake has been applied.</p>
 <p>Brake system warning lamp (yellow)</p>	<p>*The yellow brakes warning lamp lights up while the vehicle is switched on.</p> <div style="border: 1px solid gray; padding: 5px; margin: 5px 0;"> <p><b>▲ WARNING</b> Risk of an accident due to a brake system malfunction</p> <p>If the brake system is malfunctioning, braking characteristics may be impaired.</p> <ul style="list-style-type: none"> <li>► Drive on carefully.</li> <li>► Have the brake system checked immediately at a qualified specialist workshop.</li> </ul> </div> <p>► Drive on carefully at an adjusted speed and at a sufficient distance from the vehicle in front.</p> <p>► If the instrument cluster shows a display message, comply with it.</p> <p>► Consult a qualified specialist workshop.</p>
 <p>and</p>  <p>Brake warning lamp (red) (USA)</p>  <p>Brake warning lamp (red) (Canada)</p>	<p>*The red brakes warning lamp lights up while the vehicle is on.</p> <p>Possible causes:</p> <ul style="list-style-type: none"> <li>• The brake force boosting is malfunctioning.</li> <li>• The EBD (electronic brake force distribution) is malfunctioning.</li> <li>• There is insufficient brake fluid in the brake fluid reservoir.</li> </ul> <div style="border: 1px solid gray; padding: 5px; margin: 5px 0;"> <p><b>▲ WARNING</b> Risk of accident and injury if brake force boosting is malfunctioning</p> <p>If brake force boosting is malfunctioning, increased brake pedal force may be necessary for braking. The braking characteristics may be impaired. The braking distance can increase in emergency braking situations.</p> <ul style="list-style-type: none"> <li>► Stop in a safe location immediately. Do not continue driving.</li> <li>► Consult a qualified specialist workshop.</li> </ul> </div>

Warning/indicator lamp	Possible causes/consequences and ► Solutions
	<p><b>▲ WARNING</b> Risk of an accident if the EBD (electronic brake force distribution) malfunctions</p> <p>If the EBD malfunctions, the wheels may lock during braking. The braking characteristics may be impaired. The braking distance can increase in emergency situations.</p> <ul style="list-style-type: none"> <li>► Stop in a safe location immediately. Do not continue driving.</li> <li>► Consult a qualified specialist workshop.</li> </ul> <p><b>▲ WARNING</b> Risk of an accident due to low brake fluid level</p> <p>If the brake fluid level is too low, the braking effect and the braking characteristics may be impaired.</p> <ul style="list-style-type: none"> <li>► Pull over and stop the vehicle safely as soon as possible, paying attention to road and traffic conditions. Do not continue driving under any circumstances.</li> <li>► Consult a qualified specialist workshop.</li> <li>► Do not add brake fluid.</li> </ul> <p>► Stop the vehicle immediately in accordance with the traffic conditions. Do not continue driving!</p> <p>► Consult a qualified specialist workshop.</p>
 <p>and</p>  <p>Brake warning lamp (red) (USA)</p>	<p>*Only in the USA: The brake system red warning lamp lights up while the engine is on.</p> <p>Possible cause:</p> <ul style="list-style-type: none"> <li>• The brakepads have reached their wear limit.</li> </ul> <p><b>▲ WARNING</b> Risk of accident due to restricted braking power</p> <p>When the brake pads have reached their wear limit, the braking power may be restricted.</p> <ul style="list-style-type: none"> <li>► Drive on carefully.</li> <li>► Have the brake system checked immediately at a qualified specialist workshop.</li> </ul> <p>► Drive on carefully.</p> <p>► Consult a qualified specialist workshop immediately.</p>
 <p>Restraint system warning lamp</p>	<p>*The red restraint system warning lamp is on while the vehicle is switched on. The restraint system is malfunctioning.</p> <p><b>▲ WARNING</b> Risk of injury due to malfunctions in the restraint system</p> <p>Components in the restraint system may be activated unintentionally or not deploy as planned in an accident.</p> <ul style="list-style-type: none"> <li>► Have the restraint system checked and repaired immediately at a qualified specialist workshop.</li> </ul>

Warning/indicator lamp	Possible causes/consequences and ► Solutions
	<p>Detection of a restraint system malfunction:</p> <ul style="list-style-type: none"> <li>• The restraint system warning lamp  does not light up when the vehicle is switched on.</li> <li>• The restraint system warning lamp  lights up continuously or repeatedly during a journey.</li> </ul> <ul style="list-style-type: none"> <li>► Drive on carefully.</li> <li>► Note the messages on the instrument cluster.</li> <li>► Consult a qualified specialist workshop immediately.</li> </ul>
 <p>ESP® warning lamp lights up</p>	<p>*The yellow ESP® warning lamp lights up while the vehicle is switched on. ESP® is malfunctioning and/or has been deactivated automatically. Other driving systems and driving safety systems may also be malfunctioning.</p> <div style="border: 1px solid black; padding: 5px; margin: 10px 0;"> <p><b>▲ WARNING</b> Risk of skidding if ESP® is malfunctioning</p> <p>If ESP® is malfunctioning, ESP® cannot carry out vehicle stabilization. In addition, other driving safety systems are switched off.</p> <ul style="list-style-type: none"> <li>► Drive on carefully.</li> <li>► Have ESP® checked at a qualified specialist workshop.</li> </ul> </div> <ul style="list-style-type: none"> <li>► Drive on carefully.</li> <li>► Note the messages on the instrument cluster.</li> <li>► Consult a qualified specialist workshop.</li> </ul>
 <p>ESP® warning lamp flashes</p>	<p>*The ESP® yellow warning lamp flashes during a journey. ESP® intervenes (→ page 119).</p> <ul style="list-style-type: none"> <li>► Adapt your driving style to the weather and road conditions.</li> </ul>
 <p>ESP® OFF warning lamp</p>	<p>*The yellow ESP® OFF warning lamp lights up while the vehicle is on. ESP® has been switched off by the driver.</p> <div style="border: 1px solid black; padding: 5px; margin: 10px 0;"> <p><b>▲ WARNING</b> Risk of skidding when driving with ESP® deactivated</p> <p>ESP® does not act to stabilize the vehicle. The availability of further driving safety systems is also limited.</p> <ul style="list-style-type: none"> <li>► Drive on carefully.</li> <li>► Deactivate ESP® only for as long as the situation requires.</li> </ul> <p>If ESP® cannot be activated, ESP® is malfunctioning.</p> <ul style="list-style-type: none"> <li>► Have ESP® checked immediately at a qualified specialist workshop.</li> </ul> </div> <ul style="list-style-type: none"> <li>► Comply with instructions to switch ESP® off (→ page 119).</li> </ul>

Warning/indicator lamp	Possible causes/consequences and ► Solutions
 <p data-bbox="185 351 350 374">ABS warning lamp</p>	<p data-bbox="454 261 1097 310">*The yellow ABS warning lamp lights up while the vehicle is switched on. ABS is malfunctioning.</p> <p data-bbox="454 318 1073 367">If an additional warning tone sounds, this means the EBD is malfunctioning.</p> <p data-bbox="454 376 1093 424">Other driving systems and driving safety systems may also be malfunctioning.</p> <div data-bbox="465 444 1102 507" style="border: 1px solid black; padding: 5px;"> <p data-bbox="475 453 1073 501"><b>▲ WARNING</b> There is a risk of skidding if EBD or ABS is malfunctioning</p> </div> <div data-bbox="475 512 1102 722" style="border: 1px solid black; padding: 5px;"> <p data-bbox="481 516 804 539">The wheels may lock during braking.</p> <p data-bbox="481 548 1087 621">The steerability and braking characteristics are heavily impaired and the braking distance may increase. In addition, other driving safety systems are switched off.</p> <ul style="list-style-type: none"> <li data-bbox="481 630 676 654">► Drive on carefully.</li> <li data-bbox="481 663 1030 711">► Have the brake system checked immediately at a qualified specialist workshop.</li> </ul> </div> <ul style="list-style-type: none"> <li data-bbox="465 740 659 763">► Drive on carefully.</li> <li data-bbox="465 772 902 795">► Note the messages on the instrument cluster.</li> <li data-bbox="465 804 850 827">► Consult a qualified specialist workshop.</li> </ul>

**Seat belt**

Warning/indicator lamp	Possible causes/consequences and ► Solutions
 <p data-bbox="185 1057 392 1105">Seat belt warning lamp flashes</p>	<p data-bbox="454 967 1104 1016">*The red seat belt warning lamp flashes and an intermittent warning tone sounds.</p> <p data-bbox="454 1025 1097 1073">The driver or front passenger does not have their belt on while the vehicle is in motion (speeds above 15 mph (25 km/h)).</p> <ul style="list-style-type: none"> <li data-bbox="465 1082 804 1105">► Put on the seat belt (→ page 28).</li> </ul> <p data-bbox="454 1114 876 1137">There are objects on the front passenger seat.</p> <ul style="list-style-type: none"> <li data-bbox="465 1146 951 1170">► Remove the objects from the front passenger seat.</li> </ul>
 <p data-bbox="185 1265 392 1313">Seat belt warning lamp lights up</p>	<p data-bbox="454 1175 1080 1198">*The red seat belt warning lamp lights up after the vehicle has started.</p> <p data-bbox="454 1207 748 1231">A warning tone may also sound.</p> <p data-bbox="454 1240 1100 1288">When the vehicle is stationary: the seat belt warning lamp reminds drivers and front passengers to put on their seat belt.</p> <ul style="list-style-type: none"> <li data-bbox="465 1297 804 1320">► Put on the seat belt (→ page 28).</li> </ul> <p data-bbox="454 1329 1093 1379">Objects on the front passenger seat may prevent the seat belt warning lamp from going out.</p>





### Driving systems

Warning/indicator lamp	Possible causes/consequences and ► Solutions
 <p>Warning lamp for distance warning function</p>	<p>*The red distance warning lamp lights up while you are driving and a warning tone sounds. You are approaching an obstacle at too high a speed.</p> <ul style="list-style-type: none"> <li>► Be ready to apply the brakes immediately.</li> <li>► Increase the distance.</li> </ul>

### Vehicle

Warning/indicator lamp	Possible causes/consequences and ► Solutions
 <p>Electric power steering warning lamp (red)</p>	<p>*The red power steering warning lamp lights up while the vehicle is switched on. The power steering assistance or the steering itself is malfunctioning.</p> <div style="border: 1px solid gray; padding: 5px; margin: 5px 0;"> <p><b>▲ WARNING</b> Risk of accident due to impaired steering ability</p> <p>If the steering no longer functions as intended, the operational safety of the vehicle is at risk.</p> <p>► Consult a qualified specialist workshop.</p> </div> <ul style="list-style-type: none"> <li>► Note the messages on the instrument cluster display.</li> </ul>

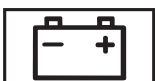

### Drive system

Warning/indicator lamp	Possible causes/consequences and ► Solutions
 <p>System malfunction warning lamp</p>	<p>*The red system error warning lamp is lit while the vehicle is in a state of operational readiness <u>READY</u>. There is a malfunction in the drive system.</p> <ul style="list-style-type: none"> <li>► Note the messages on the driver display and the instrument cluster display.</li> </ul>
 <p>Reduced warning lamp power</p>	<p>*The yellow reduced power warning lamp is lit. Drive system power output is reduced.</p> <ul style="list-style-type: none"> <li>► Note the messages on the instrument cluster display.</li> </ul>
 <p>Electrical malfunction warning lamp</p>	<p>*The red electrical malfunction warning lamp lights up. A malfunction has occurred in the electrical system.</p> <ul style="list-style-type: none"> <li>► Note the messages on the instrument cluster display.</li> </ul>
 <p>High-voltage battery reserve</p>	<p>*The yellow warning lamp for the charge level of the high-voltage battery is lit. The state of charge of the high-voltage battery has reached the reserve level.</p> <ul style="list-style-type: none"> <li>► Charge the high-voltage battery (→ page 106).</li> </ul>



Warning/indicator lamp	Possible causes/consequences and ► Solutions
 <p data-bbox="185 351 367 401">High-voltage battery warning</p>	<p data-bbox="455 261 994 310">*The red warning lamp lights up while the drive system is on. There is a malfunction in the drive system.</p> <p data-bbox="464 320 484 342">or</p> <p data-bbox="464 353 965 376">The high-voltage battery's condition of charge is too low.</p> <p data-bbox="464 387 971 410">► Note the messages on the instrument cluster display.</p>

























Tires

Warning/indicator lamp	Possible causes/consequences and ► Solutions
 <p data-bbox="185 636 406 709">Tire pressure monitoring system warning lamp flashes</p>	<p data-bbox="455 546 1060 620">*The yellow tire pressure monitoring system warning lamp (pressure loss/malfunction) flashes for approximately one minute and then remains lit. The tire pressure monitoring system is malfunctioning.</p> <div data-bbox="464 659 1102 910" style="border: 1px solid gray; padding: 5px;"> <p data-bbox="475 672 1044 720"><b>▲ WARNING</b> There is a risk of an accident if the tire pressure monitoring system is malfunctioning</p> <p data-bbox="481 734 1080 783">The tire pressure monitoring system cannot issue a warning if there is pressure loss in one or more of the tires.</p> <p data-bbox="481 793 1087 842">Tires with insufficient tire pressure may impair the driving characteristics as well as steering and braking.</p> <p data-bbox="481 852 1056 901">► Have the tire pressure monitoring system checked at a qualified specialist workshop.</p> </div> <p data-bbox="464 924 850 947">► Consult a qualified specialist workshop.</p>
 <p data-bbox="185 1055 406 1128">Tire pressure monitoring system warning lamp lights up</p>	<p data-bbox="455 965 1090 1064">*The yellow tire pressure monitoring system warning lamp (pressure loss/malfunction) lights up. The tire pressure monitoring system has detected a loss of pressure in at least one tire.</p> <div data-bbox="464 1085 1102 1358" style="border: 1px solid gray; padding: 5px;"> <p data-bbox="475 1098 1071 1121"><b>▲ WARNING</b> Risk of an accident due to insufficient tire pressure</p> <ul data-bbox="488 1132 1064 1245" style="list-style-type: none"> <li data-bbox="488 1132 689 1155">• The tires can burst.</li> <li data-bbox="488 1161 942 1184">• The tires can wear excessively and/or unevenly.</li> <li data-bbox="488 1189 1064 1245">• The driving characteristics as well as the steering and braking may be greatly impaired.</li> </ul> <p data-bbox="481 1261 854 1284">You could then lose control of the vehicle.</p> <p data-bbox="481 1295 892 1318">► Observe the recommended tire pressures.</p> <p data-bbox="481 1329 843 1352">► Adjust the tire pressure if necessary.</p> </div> <p data-bbox="464 1376 1012 1399">► Stop the vehicle in accordance with the traffic conditions.</p> <p data-bbox="464 1410 833 1433">► Check the tire pressure and the tires.</p>

- 1, 2, 3 ...
- 3-zone automatic climate control (control panel)..... 88
- A**
- A/C function..... 89
- ABS..... 118
- Accident and Breakdown Management  
Mercedes me connect..... 146
- Acoustic presence indicator..... 94
- Activating/deactivating the acoustic locking verification signal..... 40
- Active Brake Assist  
Function..... 121  
Setting..... 123
- Adaptive Highbeam Assist  
Function..... 74  
Switching on/off..... 74
- Adding fluid to the windshield washer system..... 173
- Adjusting the lights (driving abroad)..... 71
- Air bag  
Inflating..... 30  
Overview..... 34  
Warning lamp..... 29
- Air vents  
Adjusting (front)..... 91
- Air-recirculation mode..... 90
- Alarm system..... 53
- Alternative route..... 159
- Ambient lighting..... 76
- Animals..... 32
- Anti-lock braking system..... 118
- Anti-skid chain..... 191
- Anti-theft alarm system  
Activating/deactivating..... 54  
Activating/deactivating interior protection..... 55  
Function..... 53  
Interior motion sensor..... 55  
Stopping the alarm..... 54  
Switching the tow-away alarm on/off... 54  
Tow-away alarm..... 54
- Anti-theft protection  
Immobilizer..... 53
- Apps, Mercedes me  
Mercedes me connect..... 146
- Ashtray..... 66
- ASR (acceleration skid control)..... 119
- Assistance system..... 118
- Assistant display (on-board computer)..... 141
- ASSYST PLUS, After-sales service center, Service, Service interval display, Vehicle maintenance  
Battery disconnection periods..... 168  
Displaying the service due date..... 168  
Function/notes..... 168  
Regular maintenance work..... 168  
Special service requirements..... 168
- Attachments..... 15
- ATTENTION ASSIST  
Function..... 128  
Setting..... 129
- Attention assistant..... 128
- Authorised workshop..... 20
- Automatic climate control..... 90
- Automatic driving lights..... 71
- Automatic locking  
after closing the last door..... 43
- Automatic measures after an accident..... 30
- Available power display..... 140
- Axle load..... 218
- B**
- Back support, Lumbar support..... 61
- Backing up lamp  
Replacing light sources..... 79
- BAS..... 119
- Basic information..... 27
- Battery, 12 V battery, Vehicle battery  
Charging..... 183  
Charging the 12 V battery of the on-board electrical system..... 183  
Disconnecting the auxiliary battery (front passenger seat)..... 183  
High-voltage battery..... 182  
Jump-starting (vehicle)..... 183  
Key..... 40  
Notes (vehicle battery)..... 181  
Replacing the 12 V on-board electrical system battery..... 183
- Battery calibration  
Menu (on-board computer)..... 142
- Belt  
Adjusting the height..... 28  
Fastening..... 28  
Notes on wearing correctly..... 28

- Unfastening..... 34
  - Blind Spot Assist**
    - Activating/deactivating..... 130
    - Function..... 129
  - Bodies (body/equipment mounting directives)**..... 15
  - Bottle holder**..... 66
  - Brake**
    - ABS (anti-lock braking system)..... 118
    - Activating/deactivating the HOLD function..... 125
    - Active Brake Assist..... 121
    - BAS (Brake Assist System)..... 119
    - Braking with parking brake..... 100
    - Breaking-in notes..... 98
    - Downhill gradient..... 100
    - Driving instructions..... 98, 100
    - EBD (Electronic Brakeforce Distribution)..... 121
    - Heavy/light loads..... 100
    - HOLD function..... 125
    - Limited braking effect (salt-treated roads)..... 100
    - New brake disks/brake linings..... 100
    - new brake linings/brake disks..... 98
    - Post-collision brake..... 30
    - Recuperation..... 95
    - Wet road surfaces..... 100
  - Brake Assist System**..... 119
  - Brake fluid**..... 220
  - Brakeforce Distribution**..... 121
  - Braking assistance**..... 119
  - Breakdown**
    - Changing a wheel..... 207
    - Overview of assistance..... 12
    - Roadside Assistance..... 17
    - Tow-starting..... 186
    - Towing (raised rear axle)..... 185
    - Towing methods..... 184
    - Transporting the vehicle..... 185
  - Breaking-in notes**..... 98
  - Bulbs**..... 77
  - Buttons (steering wheel)**..... 138
- C**
- Calibration**
    - Automatically calibrating the high-voltage battery..... 169
    - High-voltage battery (on-board computer menu)..... 142
    - Manually calibrating the high-voltage battery..... 170
    - Notes on calibrating the high-voltage battery..... 168
  - Calling the customer center for Mercedes-Benz**..... 144
  - Calls**
    - Using overhead control panel..... 144
  - Cameras**
    - Rear-view camera..... 126
  - Car key**..... 39
  - Car wash (care)**..... 174
  - Car-to-X-Communication**
    - Display on map..... 161
  - Care**
    - Car wash..... 174
    - Exterior lighting..... 175
    - Power washer..... 174
    - Reversing camera..... 175
    - Sensors..... 175
    - Trailer hitch..... 175
    - Washing by hand..... 174
    - Wheels/rims..... 175
    - Windows..... 175
    - Wiper blades..... 175
  - Cargo compartment lamp (motion detector)**..... 76
  - Cargo compartment ventilation**..... 91
  - Cargo tie-down point**..... 225
  - Cargo tie-down points**
    - Overview..... 166
  - Cargo tie-down rings**
    - Loads..... 225
  - Carpet**
    - Cleaning..... 176
  - Central display**
    - Operating..... 150
  - Central locking system**
    - Button..... 42
  - Change of address**..... 17
  - Change of ownership**..... 17
  - Changing a wheel**
    - Installing a new wheel..... 210
    - Lowering the vehicle..... 210
    - Preparing..... 207
    - Raising the vehicle..... 208
    - Removing a wheel..... 209
  - Changing bulbs**
    - High beam..... 78

- Indicator (front)..... 78
- Low beam..... 78
- Characteristics of the tire**..... 202
- Charge level display**..... 108, 140
- Charge level/charge display**..... 108
- Charging**
  - At time of departure..... 108
  - Battery..... 183
  - Charge level display..... 108
  - Charge port, emergency release..... 114
  - Charging station, mode 3..... 111
  - Charging wirelessly (mobile phone)..... 68
  - Charging wirelessly (mobile telephone in front)..... 69
  - Configuring weekly profile..... 108
  - Ending the charging process..... 114
  - Fast charging station, mode 3/4..... 111
  - Indicator lamps on vehicle socket..... 109
  - Mains socket, mode 2..... 110
  - Notes on charging the high-voltage battery..... 106
  - Notes on the high-voltage battery..... 182
  - Starting the charging process..... 112
  - Wallbox, mode 3..... 111
- Charging settings**..... 108
- Child seat**
  - Adjusting the vehicle seat..... 37
  - Basic instructions..... 35
  - Front passenger seat..... 37
  - Risks/dangers..... 35
  - Securing to the front passenger seat with the seat belt..... 38
  - The most important information in brief..... 35
- Children**
  - Avoiding dangers in the vehicle..... 35
  - Basic instructions..... 35
  - Special seat belt retractor..... 37
- Cigarette lighter**..... 66
- Clean varnish**..... 175
- Cleaning**
  - Paint..... 175
  - Vehicle interior..... 176
  - Washing by hand..... 174
- Climate control**
  - A/C function..... 89
  - Activating/deactivating..... 89
  - Air distribution settings..... 90
  - Air vents (front)..... 91
  - Air-recirculation mode..... 90
  - Automatically regulating..... 90
- Cargo compartment ventilation (roof ventilator)..... 91
- Clearing fogged up windows..... 90
- Control panel for 3-zone automatic climate control..... 88
- Control panel for dual-zone automatic climate control..... 87
- Energy-saving use..... 88
- Notes..... 88
- Pre-entry climate control..... 92
- Refrigerant..... 222
- Setting the air distribution..... 90
- Switching the rear window heater on/off..... 91
- Switching the windshield heater on/off..... 91
- Co-driver bench seat**
  - Folding the seat surface forwards/backwards..... 62
- COC papers, CERTIFICATE OF CONFORMITY**..... 216
- Cockpit**
  - Instrument panel..... 6
- Coffee cup symbol**..... 128
- Combination switch**
  - Lights..... 72
  - Rear window wiper..... 81
  - Windshield wipers..... 81
- Commuter route**..... 159
- Components relevant to radio regulation**
  - Declaration of conformity..... 19
- Conversions**..... 15
- Coolant**
  - Capacity..... 221
  - Checking level..... 172
- Copyright**
  - License..... 25
- Copyrights**
  - Trademarks..... 26
- Cornering light**..... 73
- Correct use**..... 20
- Crosswind Assist**..... 120
- Cruise control**
  - Activating/deactivating..... 124
  - Buttons..... 124
  - Calling up a speed..... 124
  - Function..... 123
  - Increasing/decreasing the speed..... 124
  - Requirements..... 124
  - Selecting..... 124

- Setting a speed..... 124  
Storing a speed..... 124
- Cup holders**  
Center console..... 66
- Customer Assistance Center (CAC)..... 21**
- D**
- Damage**  
Limited protection..... 33
- Data processing in the vehicle..... 22**
- Data protection rights..... 25**
- Data storage**  
Data protection rights..... 25  
Electronic control units..... 22  
Event Data Recorder..... 25  
Onboard Logic Unit..... 24  
Online services..... 24
- Dealership..... 20**
- Declaration of conformity**  
Components relevant to radio regulation..... 19
- Definitions (tires and loading)..... 203**
- Departure time**  
Pre-entry climate control..... 92
- Deployed components**  
Limited protection..... 33
- Deployment situations..... 30**
- Destination entry..... 158**
- Diagnostics connection..... 19**
- Digital inside rear view mirror..... 84**
- Digital Operator's Manual..... 13**
- Digital speedometer..... 141**
- DIRECT SELECT lever**  
Drive ranges..... 104  
Engaging drive position..... 106  
Engaging neutral..... 105  
Engaging park position automatically... 105  
Engaging reverse gear..... 105  
Function..... 104  
Selecting park position..... 105  
Transmission position display..... 104
- Disconnect device (high-voltage on-board electrical system)..... 94**
- Display**  
Cleaning..... 176
- Display (on-board computer)..... 139**
- Display message, Message (instrument cluster)**  
Calling up in the on-board computer... 227  
Notes..... 227
- Display messages**
-  Coolant malfunction, stop vehicle immediately ..... 243
  -  --- mph..... 233
  -  Attention Assist Inoperative..... 234
  -  Attention Assist: Take a Break!.. 234
  -  AUTO Lamp Function Inoperative..... 245
  -  Charger Cable Connected..... 237
  -  Check Brake Fluid Level..... 230
  -  Check Tires..... 239
  -  Currently Unavailable Camera View Restricted..... 233
  -  Currently Unavailable See Operator's Manual..... 232
  -  Currently Unavailable See Operator's Manual..... 232
  -  Don't Forget Your Key..... 240
  -  Front Left Malfunction Service Required (example)..... 228
  -  Incline Too Steep See Operator's Manual..... 229
  -  Inoperative See Operator's Manual..... 232
  -  Inoperative See Operator's Manual..... 231
  -  Inoperative See Operator's Manual..... 231
  -  Key Not Detected (red display message)..... 240
  -  Key Not Detected (white display message)..... 240
  -  Left Side Curtain Airbag Malfunction Service Required (example)... 228
  -  Low Beam Left (example)..... 245
  -  Malfunction Consult a workshop..... 238
  -  Malfunction See Operator's Manual..... 245
  -  Malfunction..... 237

 Obtain a New Key.....	240	Adaptive Highbeam Assist Currently	
 Off.....	233	Unavailable See Operator's Manual.....	244
<b>HOLD</b> Off.....	234	Adaptive Highbeam Assist Inopera-	
 Parking Brake Inoperative.....	229	tive.....	244
 Parking Brake See Operator's		Air Con. Energy Saving Mode Activ.....	240
Manual.....	229	Apply Brake to Shift from 'P'.....	242
 Please Correct Tire Pressure....	239	Auxiliary Battery Malfunction.....	242
 Refill Coolant See Operator's		Blind Spot Assist Inoperative.....	234
Manual.....	244	Blind Spot Assist Trailer Not Moni-	
 Refill Washer Fluid.....	241	tored.....	234
 Replace Key Battery.....	240	Check Brake Pads See Operator's	
 Reserve Level Charge High-		Manual.....	229
Voltage Battery.....	237	CRUISE CONTROL Inoperative.....	233
 s. Operating Instructions.....	237	Currently Unavailable Radar Sen-	
 SRS Malfunction Service		sors Dirty.....	233
Required.....	228	Do Not Change Transmission Posi-	
 Steering Malfunction		tion Service Required.....	242
Increased Physical Effort See Oper-		Do Not Restart Vehicle Service	
ator's Manual.....	241	Required.....	238
 Steering Malfunction Stop		N Permanently Active Risk of Roll-	
Immediately See Operator's Manual....	241	ing Away.....	242
 Stop Immediately Drive will		Note the range.....	236
be deactivated Charge high-voltage		Note the range. Visit a workshop.....	236
battery.....	238	Only Shift to 'P' when Vehicle is	
 Stop Switch Engine Off.....	238	Stationary.....	242
 Switch Off Lights.....	244	Place Key in Marked Space See	
 Switch On Headlamps.....	244	Operator's Manual.....	240
 Towing Not Permitted See		Radar Sensors Dirty See Operator's	
Operator's Manual.....	237	Manual.....	230
 Veh. Tracking Activated See		Reduced Drive System Performance	
Op. Manual or mobile app.....	243	See Operator's Manual.....	237
 Vehicle Operational Switch		Reversing Not Possible: Service	
the Ignition Off Before Exiting.....	242	Required.....	242
 Warning Tire Malfunction.....	239	Risk of Rolling Driver's Door Open	
 Wheel Sensor(s) Missing.....	238	and Transmission Not in P.....	242
Active Brake Assist Functions Cur-		Risk of rolling, driver's seat not	
rently Limited See Operator's Man-		occupied and transmission not in P....	243
ual.....	230	Socket flap open.....	240
Active Brake Assist Functions Limi-		SOS NOT READY.....	231
ted See Operator's Manual.....	230	Tire Press. Monitor Currently	
Adaptive Highbeam Assist Camera		Unavailable.....	238
View Restricted See Operator's		Tire Pressure Monitor Inoperative.....	239
Manual.....	244		

- Tire Pressure Monitor Inoperative
  - No Wheel Sensors..... 238
  - To Deselect P or N, Depress Brake and Start Engine..... 242
  - To Engage Transmiss. Position R First Depress the Brake..... 242
  - Transmission Malfunction: Stop Vehicle..... 243
  - Wait in READY State Battery Is Warming Up See Operator's Manual.... 235
  - Displaying range (trip menu)..... 141
  - Displaying total distance (trip menu), Odometer..... 141
  - Distance warning..... 121
  - Door**
    - Activating/deactivating the automatic locking mechanism..... 43
    - Locking/unlocking mechanical key..... 44
    - Opening (from the inside)..... 41
    - Unlocking (from the inside)..... 41
  - Door control panel..... 10
  - DOT, Tire Identification Number (TIN)..... 201
  - Double co-driver's seat..... 62
  - Drinking and driving..... 98
  - Drive position display..... 104
  - Drive program display..... 104
  - Drive system, Engine
    - Manually disconnecting..... 94
    - Starting (in emergency operation mode)..... 97
    - Starting (start/stop button)..... 97
    - Switching off (start/stop button)..... 115
  - Driving in winter..... 101
  - Driving instructions
    - Acoustic presence indicator (sound generator)..... 94
    - Brakes..... 100
    - Breaking-in notes..... 98
    - Downhill gradient..... 100
    - Drinking and driving..... 98
    - Driving in winter..... 101
    - Electric mode..... 94
    - General driving tips..... 98
    - Light adjustment when driving abroad... 71
    - Limit speed..... 99
    - Limited braking effect (salt-treated roads)..... 100
    - New brake disks/brake linings..... 100
    - Parking brake..... 100
    - Recuperation..... 95
    - Slippery road surfaces..... 101
    - Subjecting brakes to a load..... 100
    - Wet road surfaces (brake)..... 100
  - Driving notes**
    - Transport by rail..... 99
  - Driving safety system**
    - ABS (anti-lock braking system)..... 118
    - Active Brake Assist..... 121
    - ASR (acceleration skid control)..... 119
    - ATTENTION ASSIST..... 128
    - BAS (Brake Assist System)..... 119
    - Blind Spot Assist..... 129
    - Cruise control..... 123
    - EBD (Electronic Brakeforce Distribution)..... 121
    - ESP® (Electronic Stability Program).... 119
    - ESP® Crosswind Assist..... 120
    - ESP® trailer stabilization..... 120
    - Hill Start Assist..... 124
    - HOLD function..... 125
    - Lane Keeping Assist/Active Lane Keeping Assist..... 131
    - Overview..... 118
    - Your responsibility..... 118
  - Driving system..... 118
  - Driving tips**
    - Driving off-road..... 101
    - Driving on flooded roads..... 100
    - Driving on wet roads..... 100
    - Hydroplaning..... 100
  - Drowsiness detection..... 128
  - Drunk driving..... 98
  - Dual-zone automatic climate control (control panel)..... 87
  - Dynamic handling control system..... 119
- E
- EBD, Electronic Brakeforce Distribution.... 121
  - EC general operating permit number..... 218
  - ECO display
    - Function..... 103
    - Resetting..... 142
  - Electric closing aid (sliding door)..... 46
  - Electric mode
    - Notes..... 94
  - Electric parking brake
    - Automatically applying..... 116
    - Emergency braking..... 117

- Manually applying/releasing..... 117
  - Notes..... 115
  - Releasing automatically..... 116
  - Electric sliding door**
    - Function..... 46
    - Open/close with button..... 46
    - open/close with key button..... 47
    - Opening with the door handle..... 48
    - Opening/closing (from the inside)..... 46
    - Resetting..... 48
    - Unlocking manually..... 48
  - Electrical fuses**
    - Notes..... 186
  - Electronic operation**
    - Functions of the energy flow display... 103
  - Electronic Stability Program**
    - Activating/deactivating..... 120
  - Electronics**
    - Engine electronics..... 216
    - Installing two-way radios..... 216
  - Emergency**
    - First-aid kit (soft sided)..... 179
    - Overview of assistance..... 12
    - Safety vest..... 179
    - Warning lamp..... 179
  - Emergency braking**
    - Electric parking brake..... 117
  - Emergency call system**
    - Automatic emergency call..... 180
    - Information..... 179
    - Manual emergency call..... 180
    - Overview..... 179
    - Transferred data..... 180
  - Emergency key**
    - Removing/inserting..... 40
  - Emergency operation mode**
    - Starting the vehicle..... 97
  - Emergency release (vehicle socket)..... 114**
  - Emergency shutoff (high-voltage on-board electrical system)..... 94**
  - Emergency start (drive system)..... 186**
  - Emergency Tensioning Devices**
    - Inflating..... 30
  - Energy consumption**
    - SmartKey..... 40
  - Energy consumption (on-board computer)..... 141**
  - Energy flow display**
    - Function/notes..... 103
  - Engaging drive position (transmission)..... 106**
  - Engaging reverse gear..... 105**
  - Engine electronics..... 216**
  - Engine number..... 218**
  - Environmental protection**
    - Driving style..... 14
  - Environmentally friendly driving style..... 14**
  - ESC, Electronic Stability Control..... 119**
  - ESP®**
    - Activating/deactivating..... 120
    - Crosswind Assist..... 120
    - Function..... 119
    - Trailer stabilization..... 120
  - Event Data Recorder..... 25**
  - Exterior lighting**
    - Care..... 175
    - Replacing illuminants (front)..... 78
- F
- Factory settings**
    - MBUX reset function..... 157
  - Fastening..... 28**
  - Favorites..... 153**
  - First aid**
    - First-aid kit (soft sided)..... 179
  - First-aid kit (soft sided)..... 179**
  - Flat tire**
    - Changing a wheel..... 207
    - Tire-change tool kit..... 207
  - Floor mats..... 69**
  - Free software..... 25**
  - Frequencies**
    - Mobile phone..... 217
    - Two-way radios..... 217
  - Front air bag**
    - Inflating..... 30
  - Front seat**
    - 8-way adjustment options..... 59
    - Adjusting (electrically)..... 59
    - Adjusting manually..... 58
    - Manually adjusting..... 56
    - Memory function..... 59
    - Rotating..... 61
  - Function the event of an accident..... 31**
  - Fuses**
    - Fuse box (co-driver footwell)..... 187
    - Fuse box (seat base of driver's seat).... 187
    - Notes..... 186



- G**
- General operating permit number (EC)..... 218
  - Genuine parts..... 14
  - Getting in/getting out..... 44
  - Grab handles
    - Using..... 44
  - Gross axle weight rating..... 218
- H**
- Handling characteristics
    - Unusual..... 190
  - Hazard warning light system..... 73
  - Hazard warnings
    - Car-to-X-Communication..... 161
  - Head restraint
    - Manually adjusting..... 63
  - Headlamp flashing..... 72
  - Heating system..... 86
  - High beam
    - Activating/deactivating..... 72
    - Adaptive Highbeam Assist..... 74
    - Changing bulbs..... 78
  - High-voltage battery, Battery (high-voltage on-board electrical system)
    - Calibrating (on-board computer menu)..... 142
    - Calibration..... 169
    - Charge level display..... 108
    - Charge port, emergency release..... 114
    - Charging at time of departure..... 108
    - Charging duration..... 222
    - Charging station, mode 3..... 111
    - Configuring weekly profile..... 108
    - Disconnect device..... 94
    - Ending the charging process..... 114
    - Energy content..... 222
    - Energy flow display..... 103
    - Fast charging station, mode 3/4..... 111
    - General notes on charging..... 106
    - Mains socket, mode 2..... 110
    - Manually calibrating..... 170
    - Notes..... 182
    - Notes on calibrating..... 168
    - Starting the charging process..... 112
    - Type..... 222
    - Wallbox, mode 3..... 111
  - High-voltage on-board electrical system
    - Indicator lamps on vehicle socket..... 109
  - Hill Start Assist..... 124
  - HOLD function
    - Notes..... 125
    - Switching on/off..... 125
  - Home screen
    - Central display..... 150
  - Hydroplaning..... 100
- I**
- Identification plate..... 218
  - Immobilizer..... 53
  - Inattention detection..... 128
  - Incorrect behavior by vehicle occupants
    - Limited protection..... 31
  - Indicator
    - Changing bulbs (front)..... 78
  - Indicator lamps
    - Overview..... 7
  - Inside rear view mirror
    - Digital inside rear view mirror..... 84
  - Inside rear view mirror display
    - Rear view camera..... 127
  - Inside rearview mirror
    - Adjusting/setting anti-glare mode..... 85
  - Installation of accessories
    - Limited protection..... 32
  - Installations..... 15
  - Instrument cluster, Instrument display
    - Adjusting the lighting..... 141
    - Available power display..... 140
    - Charge level display..... 140
    - Function/notes..... 137
    - Overview..... 7, 137
    - Power display..... 137
  - Instrument cluster display (on-board computer)..... 139
  - Instrument lighting, Dashboard lighting..... 141
  - Instrument panel
    - Cockpit..... 6
  - Intelligent light system
    - Adaptive Highbeam Assist..... 74
    - Cornering light..... 73
  - Interior lamp
    - Replacing illuminants (rear passenger compartment)..... 80
  - Interior lighting
    - Ambient lighting..... 76
    - Box bodies..... 75
    - Cargo compartment..... 76

- Motion detector (rear passenger compartment)..... 76
- Rear compartment..... 76
- Setting..... 75
- Switch-off delay time..... 77
- Interior motion sensor**
  - Activating/deactivating..... 55
  - Function..... 55
- Internet**
  - Mercedes me connect..... 146
  - Setting up a Wi-Fi hotspot..... 155
  - Web browser..... 163
- J**
- Jack**
  - Hydraulic..... 188
  - Removing from stowage compartment (hydraulic jack)..... 188
  - Storage location..... 207
  - Storage location (hydraulic jack)..... 188
- Journeys abroad**
  - Light adjustment low beam..... 71
- Jump-start connection, Starting assistance**..... 183
- K**
- Key**
  - Battery..... 40
  - Central locking system..... 40
  - electric sliding door open/close..... 47
  - Emergency key..... 40
  - Fastening to keyring..... 40
  - Functions..... 39
  - Pre-entry climate control..... 92
  - Problem..... 41
  - Radio connection..... 39
  - Unlocking setting..... 40
- L**
- Lamp**..... 77
- Lane Keeping Assist**
  - Function..... 131
  - System limits..... 131
  - Trailer operation..... 131
- Language**
  - Notes..... 156
  - Setting..... 157
- License plate lamp**
  - Replacing light bulbs..... 80
- Light switch (overview)**..... 71
- Lights, Lighting**
  - Activating/deactivating the surround lighting..... 74
  - Adaptive Highbeam Assist..... 74
  - Adjusting the instrument lighting..... 141
  - Automatic driving lights..... 71
  - Combination switch..... 72
  - Cornering light..... 73
  - Hazard warning lights..... 73
  - Headlamp flashing..... 72
  - Headlamp range..... 72
  - High beam..... 72
  - Light adjustment when driving abroad... 71
  - Light switch..... 71
  - Low beam..... 71
  - Parking light..... 71
  - Rear fog light..... 71
  - Responsibility with lighting systems..... 71
  - Switch-off delay time..... 74
  - Turn signal light..... 72
- Limit speed**
  - Notes..... 99
- Limited Warranty**..... 22
- Load**
  - Determining the maximum..... 198
  - Sample calculation..... 198
- Load distribution**..... 164
- Load securing**
  - Cargo tie-down points..... 166
  - Notes..... 165
- Load-bearing capacity (tires)**..... 202
- Loading**
  - Definitions..... 203
- Loading guidelines**..... 164
- Loading information table**..... 197
- Locking/unlocking**
  - Activating/deactivating the automatic locking mechanism..... 43
  - Automatic locking (MMS)..... 43
  - Doors (interior)..... 41
  - Mechanical key..... 44
- Low beam**
  - Activating/deactivating..... 71
  - Changing bulbs..... 78
  - Light adjustment when driving abroad... 71
- Lubricants**
  - Notes on operating fluids..... 219
- Lumbar support (4-way)**..... 61
- M**
- M+S tires**..... 191

- Maintenance**
    - Carpet..... 176
    - Display..... 176
    - Paint..... 175
    - Plastic trim..... 176
    - Real wood/trim elements..... 176
    - Roof lining..... 176
    - Seat belt..... 176
    - Seat cover..... 176
    - Vehicle..... 17
  - Malfunction**
    - Restraint system..... 29
  - Malfunction message**
    - Notes on display messages..... 227
  - Map**
    - Displaying online map contents..... 161
    - Displaying weather information..... 161
    - Moving..... 160
    - Selecting the map orientation..... 160
    - Setting the map scale..... 160
  - Map functions**..... 160
  - Maximum gross vehicle weight**..... 218
  - Maximum load**
    - Determining..... 198
    - Sample calculation..... 198
  - Maximum tire load**..... 201
  - Maximum tire pressure**..... 202
  - MBUX multimedia system**
    - Factory setting..... 157
    - Home screen..... 150
    - Language settings..... 151
    - Mercedes me & Apps..... 147
    - Notes..... 149
    - Overview..... 149
    - Touchscreen..... 150
  - MBUX Voice Assistant**
    - Function..... 151
    - Voice prompting..... 152
  - Mechanical key**
    - Locking/unlocking the door..... 44
  - Medical aids**..... 21
  - Memory function**
    - Outside mirrors..... 61
    - Seat..... 61
  - Menu (on-board computer)**
    - Assistance graphic..... 141
    - Battery calibration..... 142
    - Service..... 141
    - Settings..... 143
    - Trip..... 141
  - Mercedes me app**
    - Calling up services..... 148
    - Calling up your user account..... 147
    - Unlinking the user account..... 148
  - Mercedes me Apps**..... 147
  - Mercedes me calls**
    - Arranging a service appointment..... 144
    - Consenting to the transfer of data..... 145
    - Information on call using overhead control panel..... 144
    - Making a call via the overhead control panel..... 144
    - Mercedes-Benz customer center..... 144
    - Transferred data..... 145
  - Mercedes me connect**
    - Accident and Breakdown Management..... 146
    - Information..... 146
    - Making a call via the overhead control panel..... 144
    - Transferred data..... 147
  - Message memory**..... 227
  - Mirror**
    - Adjusting/setting anti-glare mode (inside rearview mirror)..... 85
    - Adjusting/setting anti-glare mode (outside mirrors)..... 83
  - Mirrors**
    - Digital inside rear view mirror..... 84
  - Mobile phone**
    - Frequencies..... 217
    - Maximum transmission output..... 217
    - Wireless charging (front)..... 69
  - Modification**
    - Limited protection..... 33
  - Motion detector (cargo compartment)**..... 76
  - Mounting a load**..... 164
  - Multi Purpose Vehicle (MPV)**..... 20
  - Multifunction steering wheel**
    - Overview of buttons..... 138
  - Multimedia system**..... 149
- N
- Navigation**
    - Activating..... 157
    - Destination entry..... 158
    - Overview..... 157
  - Nominal tensile load of cargo tie-down rings**..... 225

<b>O</b>	
<b>Objects in the vehicle interior</b>	
Limited protection.....	32
<b>Occupant safety</b>	
Air bag.....	34
Automatic measures after an accident..	30
Basic information.....	27
Child seat.....	35
Information on the child restraint system.....	30
Information on the correct seat position.....	27
Pets in the vehicle.....	32
<b>On-board computer</b>	
Assistant display menu.....	141
Battery calibration menu.....	142
Displaying the service due date.....	168
Instrument cluster display.....	139
Operation.....	138
Overview.....	138
Service menu.....	141
Settings menu.....	143
Trip menu.....	141
<b>On-board diagnostic interface.....</b>	19
<b>On-board electronics</b>	
Engine electronics.....	216
Installing two-way radios.....	216
<b>Onboard Logic Unit</b>	
Data storage.....	24
Online services.....	24
<b>Online services.....</b>	24
<b>Open-source software.....</b>	25
<b>Opening/closing the hood.....</b>	171
<b>Operating fluids</b>	
Brake fluid.....	220
Notes.....	219
Notes on coolant (drive system).....	220
Refrigerant (air conditioning system)...	222
Windshield cleaning agent.....	221
<b>Operating safety.....</b>	17
<b>Operator's Manual.....</b>	16
<b>Operator's Manual digital.....</b>	13
<b>Outside mirrors</b>	
Adjusting/setting anti-glare mode.....	83
Blind Spot Assist.....	129
Folding in/out.....	83
Memory function.....	61
Setting options.....	10
<b>Overhead control panel</b>	
Adjusting the interior lighting.....	75
Overview.....	8
<b>P</b>	
<b>Paint code.....</b>	218
<b>Park position</b>	
Engaging.....	105
Selecting automatically.....	105
<b>Parking for an extended period.....</b>	117
<b>Parking light.....</b>	71
<b>Partition sliding door</b>	
Opening/closing.....	51
<b>Permissible gross mass.....</b>	218
<b>Permitted towing methods</b>	
Overview.....	183
<b>Personalization.....</b>	152
<b>Pets in the vehicle.....</b>	32
<b>Placing a load on the wheel arch.....</b>	167
<b>Plastic trim (care).....</b>	176
<b>Post-collision brake.....</b>	30
<b>Power display</b>	
Function/notes.....	137
<b>Power supply</b>	
Switching on (start/stop button).....	96
<b>Power washer (care).....</b>	174
<b>Pre-entry climate control</b>	
Activating.....	92
Notes.....	92
Switching on/off via the button.....	93
Via the key.....	92
<b>Profile.....</b>	152
<b>Program selector button, Drive programs</b>	
Drive program display.....	104
Drive programs.....	104
Function.....	104
Selecting the drive program.....	104
<b>Protection</b>	
Limited.....	31
<b>Pulling away.....</b>	124
<b>Q</b>	
<b>QR code rescue card.....</b>	22
<b>Qualified specialist workshop.....</b>	20
<b>R</b>	
<b>Radar sensors</b>	
Care.....	175





























- Radio connection**
    - Key..... 39
  - Radio regulations**
    - Regulatory radio identification..... 217
  - Real wood (care)**..... 176
  - Rear compartment lighting (motion detector)**..... 76
  - Rear fog light**..... 71
  - Rear view camera**
    - Inside rear view mirror display..... 127
  - Rear window wiper**
    - Switching on/off..... 81
  - Rear-end doors**
    - open over 90°..... 50
    - Opening/closing (from the inside)..... 50
    - Opening/closing (from the outside)..... 49
  - Rear-view camera**
    - Display/hide the inside rear-view mirror display..... 128
    - Function..... 126
  - Recuperation**
    - Function..... 95
    - Setting..... 96
  - Refrigerant (air conditioning system)**..... 222
  - Registration**..... 20
  - Regulating headlamp range**..... 72
  - Regulatory radio information**
    - Specific absorption rate..... 217
  - Replacement key, Spare key**..... 41
  - Replacing**
    - Fuses..... 186
  - Replacing light bulbs**
    - Interior lamp (rear passenger compartment)..... 80
    - License plate lamp..... 80
    - Light sources (front)..... 78
    - Notes..... 77
  - Replacing light sources**
    - Backing up lamp..... 79
    - Tail lamp types..... 79
    - Turn signal lights (rear)..... 79
  - Reporting safety defects**..... 22
  - Rescue card, QR code**..... 22
  - Rescue separation point (high-voltage on-board electrical system)**..... 94
  - Resetting**
    - MBUX reset function..... 157
  - Responsibility**
    - Driving safety systems..... 118
  - Restraint system**
    - Basic information..... 27
    - Basic instructions for children..... 35
    - Deployment situations..... 30
    - Functionality..... 29
    - Information on function..... 31
    - Information on the correct seat position..... 27
    - Limited protection..... 33
    - Malfunction..... 29
    - Protection..... 27
    - Self-test..... 29
    - Warning lamp..... 29
  - Reversing camera**
    - Care..... 175
  - Roadside Assistance (breakdown)**..... 17
  - Roll-away prevention**..... 125
  - Roof lining (care)**..... 176
  - Roof load**..... 225
  - Roof luggage rack, Carrier system**
    - Loads..... 225
    - Securing..... 166
  - Roof ventilator**
    - Activating/deactivating cargo compartment ventilation..... 91
  - Route**
    - Alternative route..... 159
    - Calculating..... 159
    - Commuter route..... 159
    - Navigation..... 157
    - Selecting a type..... 159
- S
- Safety system**..... 118
  - Safety vest**..... 179
  - Seat, Driver's seat**
    - 4-way lumbar support..... 61
    - 8-way adjustment options..... 59
    - Adjusting electrically (front)..... 59
    - Adjusting manually (front)..... 56, 58
    - Adjusting the head restraint manually.... 63
    - Adjusting the seat surface (co-driver bench seat)..... 62
    - Correct driver's seat position..... 56
    - Door control panel..... 10
    - Folding the folding seat up/down..... 63
    - Memory function..... 59, 61
    - Rotating (front seat)..... 61
    - Side impact air bag..... 34

- Switching seat heating on/off..... 64
- Seat belt**
  - Adjusting the height..... 28
  - Cleaning..... 176
  - Fastening..... 28
  - Notes on wearing correctly..... 28
  - Unfastening..... 34
  - Warning lamp..... 29
- Seat belt warning**..... 29
- Seat cover (care)**..... 176
- Securing loads**
  - Cargo tie-down rings..... 166
- Securing luggage**..... 164
- Selector lever**..... 104
- Self-test**
  - Restraint system..... 29
- Sensors (care)**..... 175
- Service (on-board computer)**..... 141
- Service center**..... 20
- Setting the air distribution**..... 90
- Settings (on-board computer)**..... 143
- Shifting to neutral (transmission)**..... 105
- Side windows**
  - Opening/closing..... 52
  - Problem..... 53
  - Resetting..... 53
- Size designation (tires)**..... 202
- Sliding door**
  - electric sliding door..... 46
  - electrical closing aid..... 46
  - Function..... 46
  - Open/close with button..... 46
  - Opening/closing (from the inside)..... 45
  - opening/closing (from the outside)..... 45
- Slippery road surfaces**..... 101
- SmartKey**
  - Acoustic locking verification signal..... 40
  - Deactivating the function..... 40
  - Energy consumption..... 40
- Smartphone Integration, iPhone®**
  - Android Auto..... 162
  - Apple CarPlay®..... 162
- Snow chains**..... 191
- Socket**
  - Trailer hitch..... 133
- Socket (12 V)**
  - Center console (front)..... 67
- Socket (115 V)**
  - Front center console..... 67
  - Notes..... 67
- Socket flap**..... 112
- Software update**..... 154
- SOS button**..... 144
- Sound**
  - Menu..... 163
- Sound generator**..... 94
- Sound settings**..... 163
- Spare parts**..... 14
- Spare wheel**
  - Installing/removing..... 212
  - Notes..... 211
- Special seat belt retractor**..... 37
- Specialist workshop**..... 20
- Specific absorption rate (SAR)**..... 217
- Speed control**
  - Cruise control..... 123
- Speed limit**
  - Winter tires..... 124
- Speed rating (tires)**..... 202
- Speedometer (digital)**..... 141
- Start-off assist**..... 124
- Start/stop button**
  - Parking the vehicle..... 115
  - Starting the vehicle..... 97
  - Switching on the power supply or the vehicle..... 96
- Starting-off aid**..... 124
- Steering wheel**
  - Adjusting..... 64
  - Buttons..... 138
  - Driver's air bag..... 34
  - Steering wheel heater..... 65
- Steering wheel heater**..... 65
- Stopping the alarm**..... 54
- Stowage areas**..... 65
- Stowage compartment (vehicle tool kit)..... 187**
- Stowage space**
  - Armrest..... 65
  - Bottle holder..... 66
  - Center console..... 65
  - Door..... 65
  - Glove box..... 65
- Substances hazardous to health**..... 17
- Summer tires**..... 190

- Surround lighting..... 74
  - Switch-off delay time
    - Exterior..... 74
    - Interior..... 77
  - Switching on the vehicle (start/stop button)..... 96
  - Switching seat heating on/off..... 64
  - Switching the rear window heater on/off..... 91
  - Switching the windshield heater on/off..... 91
  - System settings
    - MBUX reset function..... 157
    - Overview..... 154
- T**
- Technical data
    - Coolant filling capacity..... 221
    - Information..... 216
    - Notes on trailer hitch..... 223
    - Radio regulations..... 217
    - Specific absorption rate (SAR)..... 217
    - Tire pressure monitoring system..... 197
    - Vehicle dimensions..... 222
    - Vehicle identification plate..... 218
  - Telephone
    - Charging wirelessly (mobile telephone in front)..... 69
  - Tire and Loading Information placard..... 197
  - Tire Identification Number (TIN)..... 201
  - Tire information table..... 197
  - Tire labeling, Labeling (tires)
    - Characteristics..... 202
    - DOT, Tire Identification Number (TIN).. 201
    - Load-bearing capacity..... 202
    - Maximum tire load..... 201
    - Maximum tire pressure..... 202
    - Overview..... 200
    - Size designation..... 202
    - Speed rating..... 202
    - Temperature grade..... 200
    - Tire quality grades..... 200
    - Tread wear grade..... 200
  - Tire load (maximum)..... 201
  - Tire pressure
    - Checking manually..... 196
    - Maximum..... 202
    - Notes..... 192
    - Restarting the tire pressure monitoring system..... 196
    - Tire pressure monitoring system..... 194, 196
    - Tire pressure table..... 193
  - Tire pressure monitoring system
    - Checking the air pressure..... 196
    - Checking the temperature..... 196
    - Function..... 194
    - Restarting..... 196
    - Technical data..... 197
  - Tire pressure table..... 193
  - Tire temperature
    - Checking..... 196
    - Tire pressure monitoring system..... 194
  - Tire tread..... 190
  - Tire-change tool kit..... 207
  - Tires
    - Characteristics..... 202
    - Checking..... 190
    - Checking the temperature..... 196
    - Definitions..... 203
    - Direction of rotation..... 207
    - DOT, Tire Identification Number (TIN).. 201
    - Installing..... 210
    - Load-bearing capacity..... 202
    - M+S tires..... 191
    - Maximum tire load..... 201
    - Maximum tire pressure..... 202
    - Mounting..... 205
    - Noise..... 190
    - Overview of tire labeling..... 200
    - Removing..... 209
    - Replacing..... 205, 207
    - Restarting the tire pressure monitoring system..... 196
    - Selection..... 205
    - Size designation..... 202
    - Snow chains..... 191
    - Speed rating..... 202
    - Storing..... 207
    - Summer tires..... 190
    - Tire and Loading Information placard.. 197
    - Tire pressure monitoring system..... 194
    - Tire pressure table..... 193
    - Tire quality grades..... 200
    - Unusual handling characteristics..... 190
    - Wheel size categories..... 206
  - Touch Control
    - MBUX..... 150
  - Touchscreen..... 150
  - Tow-away alarm
    - Activating/deactivating..... 54
    - Function..... 54
  - Tow-starting..... 186
  - Towing
    - Raised rear axle..... 185

- Towing methods..... 183
  - Towing eye**
    - Installing/removing..... 185
    - Storage location..... 185
  - Towing methods**
    - Both axles on the ground..... 184
    - Overview..... 183
  - Trailer hitch**
    - Care..... 175
    - Coupling/uncoupling a trailer..... 133
    - Information..... 134
    - Information about trailer operation..... 131
    - Notes..... 223
    - Permissible trailer loads and trailer drawbar noseweights..... 135
    - Power supply..... 136
    - Socket..... 133
  - Trailer loads**..... 223
  - Trailer operation**
    - Coupling/uncoupling a trailer..... 133
    - Information..... 134
    - Lane Keeping Assist..... 131
    - Notes..... 131
    - Permissible trailer loads and trailer drawbar noseweights..... 135
    - Power supply..... 136
    - Setting..... 134
    - Socket..... 133
    - Trailer loads..... 223
  - Trailer stabilization**..... 120
  - Transmission**
    - DIRECT SELECT lever..... 104
    - Drive program display..... 104
    - Drive programs..... 104
    - Drive ranges..... 104
    - Engaging drive position..... 106
    - Engaging neutral..... 105
    - Engaging reverse gear..... 105
    - Program selector button..... 104
    - Selecting park position..... 105
    - Transmission position display..... 104
  - Transport (vehicle)**..... 185
  - Transport by rail**..... 99
  - Trim element (care)**..... 176
  - Trip**
    - Displaying total distance..... 141
    - Menu (on-board computer)..... 141
  - Trip computer**
    - Displaying..... 141
    - Resetting..... 142
  - Trip distance**, Distance recorder, Trip odometer
    - Displaying..... 141
    - Resetting..... 142
  - Turn signal light**
    - Changing bulbs (rear)..... 79
  - Two-way radios**
    - Frequencies..... 217
    - Installation..... 216
    - Maximum transmission output..... 217
- U**
- Unfastening**..... 34
  - Unlocking setting**..... 40
  - Updates**..... 154
  - User profiles**
    - Adding a user..... 153
    - Note..... 152
    - Selecting options..... 153
  - Using the chock**..... 118
- V**
- Vehicle**, Starting the vehicle
    - Activating/deactivating the automatic locking mechanism..... 43
    - Correct use..... 20
    - Data storage..... 22
    - Diagnostics connection..... 19
    - Equipment..... 16
    - Identification plate..... 218
    - Limited Warranty..... 22
    - loading..... 185
    - lock automatically..... 43
    - lock automatically (MMS)..... 43
    - Locking/unlocking (from the inside)..... 42
    - Locking/unlocking mechanical key..... 44
    - Lowering..... 210
    - Maintenance..... 17
    - Medical aids..... 21
    - Parking for an extended period..... 117
    - Problem notification..... 21
    - QR code rescue card..... 22
    - Raising..... 208
    - Registration..... 20
    - Starting (in emergency operation mode)..... 97
    - Starting (start/stop button)..... 97
    - Switching off (start/stop button)..... 115
    - Switching on the power supply (start/stop button)..... 96
    - Towing away..... 183



- Vehicle data**
- Vehicle height..... 222
  - Vehicle length..... 222
  - Vehicle width..... 222
  - Wheelbase..... 222
- Vehicle equipment**..... 16
- Vehicle identification number**..... 218
- Vehicle identification plate**..... 218
- Vehicle key**..... 39
- Vehicle operation outside the USA or Canada**..... 16
- Vehicle socket**
- Emergency release..... 114
  - Indicator lamps..... 109
- Vehicle tool kit, Tool**
- Removing..... 188
  - Stowage compartment..... 187
  - Towing eye..... 185
- Vehicle's high-voltage on-board electrical system**
- Charge port, emergency release..... 114
  - Disconnect device..... 94
  - Manually disconnecting..... 94
  - Rescue separation point..... 94
- Vents**..... 91
- VIN**..... 218
- Voice assistant**
- Voice prompting..... 152
- W**
- Warning lamp**..... 179
- Warning system**..... 53
- Warning/indicator lamp**
-  ABS warning lamp..... 251
  -  and..... 246, 247, 248, 249
  -  Brake system warning lamp (yellow)..... 248
  -  Brake warning lamp (red) (Canada)..... 248
  -  Brake warning lamp (red) (USA)..... 248, 249
  -  Electric parking brake applied red indicator lamp (Canada) does not light up..... 246
  -  Electric parking brake applied red indicator lamp (USA) does not light up..... 246
  -  Electric parking brake malfunctioning yellow indicator lamp lights up..... 246, 247
  -  Electric power steering warning lamp (red)..... 252
  -  Electrical malfunction warning lamp..... 252
  -  ESP® OFF warning lamp..... 250
  -  ESP® warning lamp flashes..... 250
  -  ESP® warning lamp lights up..... 250
  -  High-voltage battery reserve..... 252
  -  High-voltage battery warning..... 253
  -  Red electric parking brake applied indicator lamp (Canada) flashes..... 247
  -  Red electric parking brake applied indicator lamp (Canada) lights up..... 246, 247
  -  Red electric parking brake applied indicator lamp (USA) flashes... 247
  -  Red electric parking brake applied indicator lamp (USA) lights up..... 246, 247
  -  Red parking brake applied indicator lamp (Canada) lights up..... 248
  -  Red parking brake applied indicator lamp (USA) lights up..... 248
  -  Reduced warning lamp power... 252
  -  Restraint system warning lamp..... 249
  -  Seat belt warning lamp flashes..... 251
  -  Seat belt warning lamp lights up..... 251
  -  System malfunction warning lamp..... 252
  -  The electric parking brake malfunctioning yellow indicator lamp does not light up..... 247
  -  Tire pressure monitoring system warning lamp flashes..... 253
  -  Tire pressure monitoring system warning lamp lights up..... 253

-  Warning lamp for distance
  - warning function..... 252
- Warning/indicator lamps**
- Overview..... 7, 245
- Warranty terms and conditions**..... 16
- Washer fluid**..... 221
- Washing by hand**..... 174
- Wear**
- Limited protection..... 33
- Weather information**..... 161
- Web browser**..... 163
- WET WIPER SYSTEM**..... 82
- Wheel rotation**..... 206
- Wheel wrench**..... 207
- Wheels**
- Care..... 175
  - Changing..... 206
  - Characteristics of the tire..... 202
  - Checking..... 190
  - Checking the air pressure..... 196
  - Checking the temperature..... 196
  - Definitions..... 203
  - DOT, Tire Identification Number (TIN).. 201
  - Flat tire..... 181
  - Installing..... 210
  - Load-bearing capacity..... 202
  - Maximum tire load..... 201
  - Maximum tire pressure..... 202
  - Mounting..... 205
  - Noise..... 190
  - Overview of tire labeling..... 200
  - Removing..... 209
  - Replacing..... 205, 207
  - Restarting the tire pressure monitoring system..... 196
  - Selection..... 205
  - Size designation..... 202
  - Snow chains..... 191
  - Speed rating..... 202
  - Storing..... 207
  - Tire and Loading Information placard.. 197
  - Tire pressure..... 192
  - Tire pressure monitoring system..... 194
  - Tire pressure table..... 193
  - Tire quality grades..... 200
  - Tread wear grade..... 200
  - Unusual handling characteristics..... 190
  - Wheel size categories..... 206
- Wheels (care)**..... 175
- Wi-Fi**
- Setting up a hotspot..... 155
- Window curtain air bag**..... 34
- Windows**
- Opening/closing..... 52
- Windows (care)**..... 175
- Windshield**
- Replacing the wiper blades..... 81
- Windshield cleaning agent**..... 221
- Windshield wiper**
- Replacing wiper blades (rear window).... 83
  - Switching on/off (rear window)..... 81
- Windshield wipers**
- Replacing the wiper blades..... 81
  - Replacing the wiper blades (WET WIPER SYSTEM)..... 82
  - Replacing the wiper blades (windshield)..... 81
  - Switching on/off..... 81
  - Switching on/off (windshield)..... 81
- Winter operation**..... 191
- Winter tires**
- Notes..... 191
  - Setting the permanent speed limit..... 124
  - Speed limiter..... 124
- Wiper blades**
- Care..... 175
  - Replacing (rear window)..... 83
  - Replacing (WET WIPER SYSTEM)..... 82
  - Replacing (windshield)..... 81
- Wireless charging**
- Mobile telephone (front)..... 69
  - Notes..... 68
- Workshop**..... 20

